

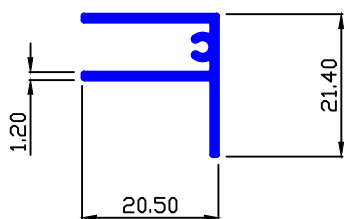

TRANSPORT ROAD

MAAN SEC.-6727

0.215 Kg/Mtr.



MAAN SEC.-6983

0.485 Kg/Mtr.

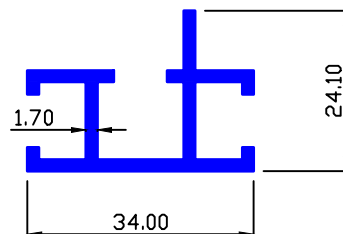

MAAN SEC.-6985

0.315 Kg/Mtr.

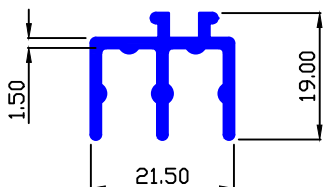

MAAN SEC.-7060

0.217 Kg/Mtr.

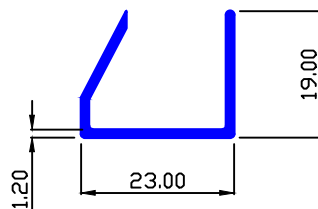

MAAN SEC.-7066

1.536 Kg/Mtr.

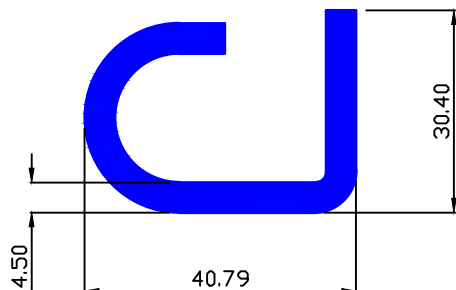

MAAN SEC.-7068

0.151 Kg/Mtr.

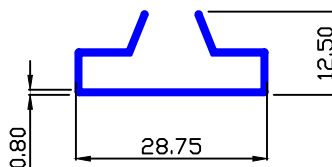

MAAN SEC.-7082

0.079 Kg/Mtr.

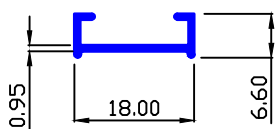

MAAN SEC.-7094

0.292 Kg/Mtr.

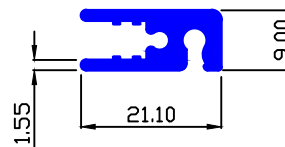

MAAN SEC.-7113

0.186 Kg/Mtr.

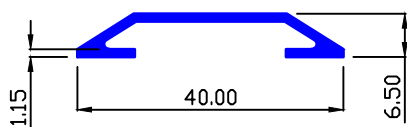

MAAN SEC.-90741

0.684 Kg/Mtr.

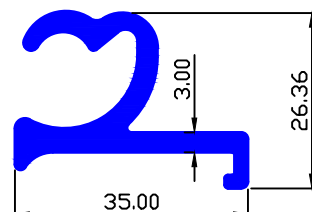



TRANSPORT ROAD

MAAN SEC.-7120/EL

0.350 Kg/Mtr.

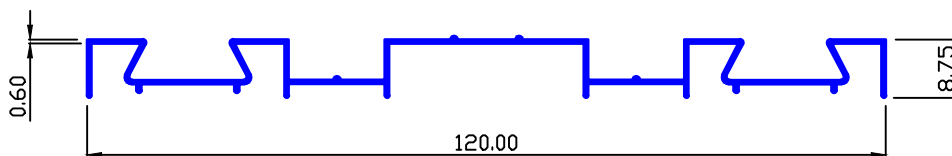

MAAN SEC.-7120/L

0.428 Kg/Mtr.

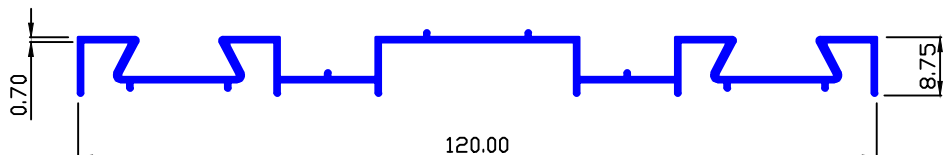

MAAN SEC.-7121/L

0.626 Kg/Mtr.

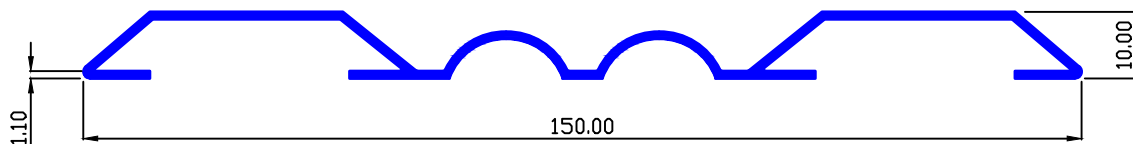

MAAN SEC.-7122

0.465 Kg/Mtr.

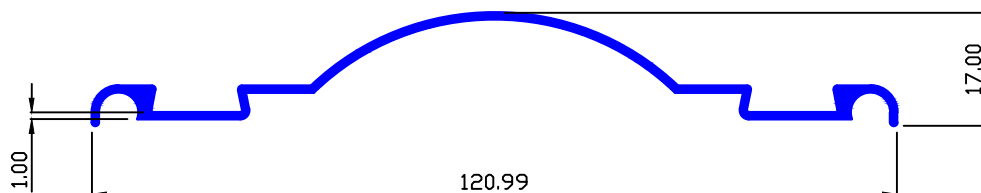

MAAN SEC.-7124

0.230 Kg/Mtr.

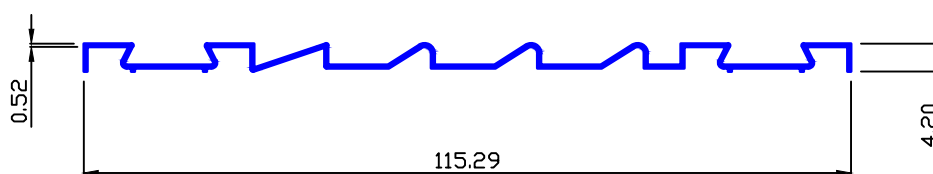



TRANSPORT ROAD

MAAN SEC.-7125

0.192 Kg/Mtr.

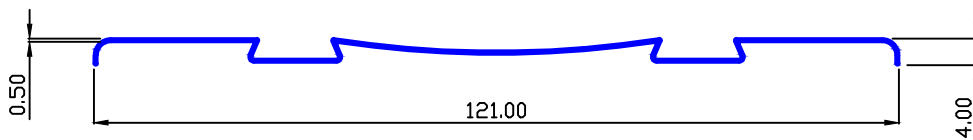

MAAN SEC.-7126

0.202 Kg/Mtr.

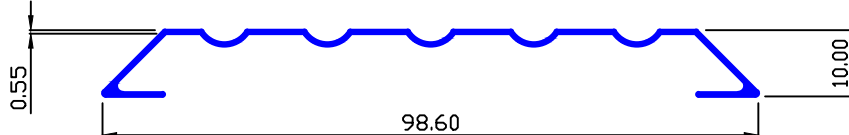

MAAN SEC.-7127

0.233 Kg/Mtr.

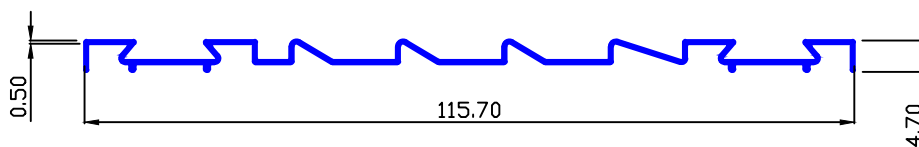

MAAN SEC.-7204

0.410 Kg/Mtr.

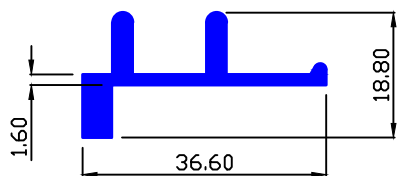

MAAN SEC.-7207

0.349 Kg/Mtr.

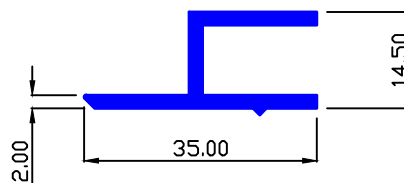

MAAN SEC.-7213

0.506 Kg/Mtr.

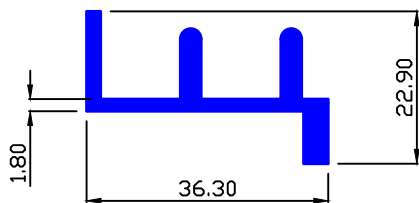

MAAN SEC.-7215

0.136 Kg/Mtr.

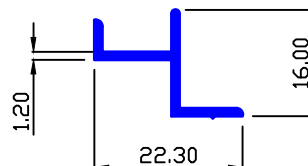

MAAN SEC.-7216

0.125 Kg/Mtr.

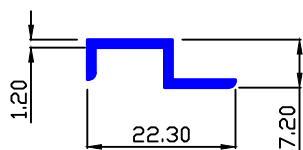

MAAN SEC.-7227

0.650 Kg/Mtr.

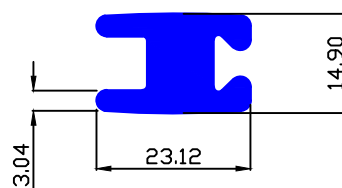



TRANSPORT ROAD

MAAN SEC.-7224

0.611 Kg/Mtr.

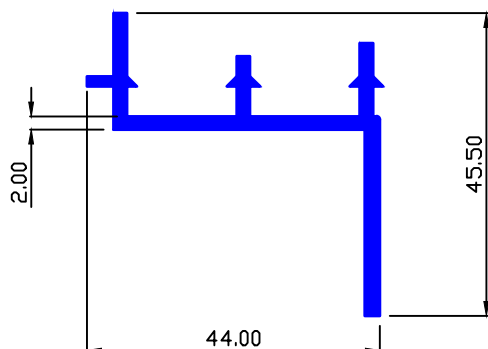

MAAN SEC.-7226

0.643 Kg/Mtr.

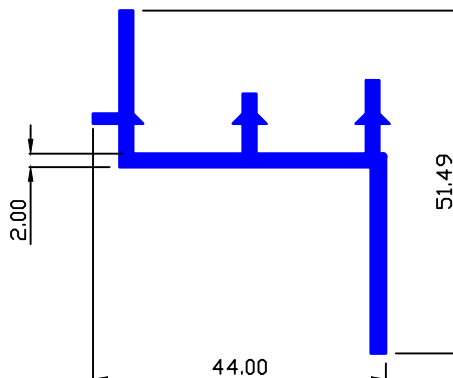

MAAN SEC.-7231

0.365 Kg/Mtr.

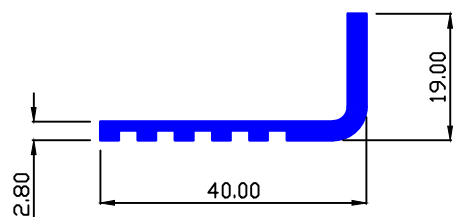

MAAN SEC.-7235

0.533 Kg/Mtr.

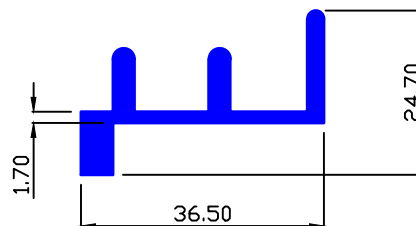

MAAN SEC.-7236

0.253 Kg/Mtr.

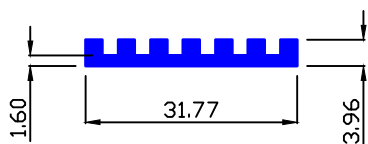

MAAN SEC.-7237

0.448 Kg/Mtr.

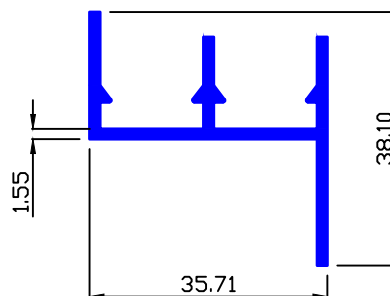

MAAN SEC.-7238

0.473 Kg/Mtr.

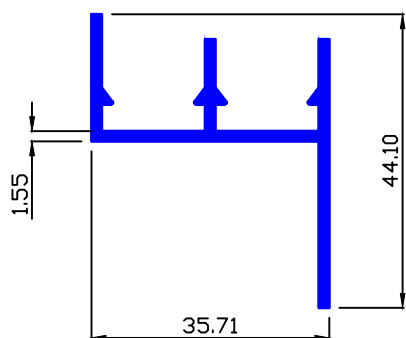

MAAN SEC.-7239

0.599 Kg/Mtr.

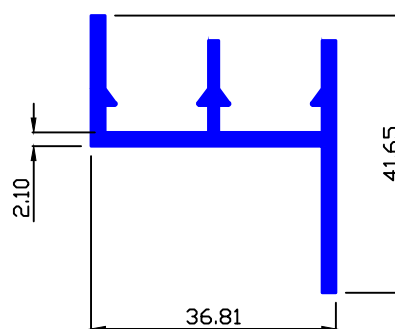



TRANSPORT ROAD

MAAN SEC.-7504/L

0.074 Kg/Mtr.

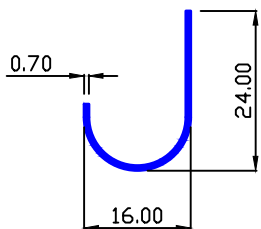

MAAN SEC.-7505

0.242 Kg/Mtr.

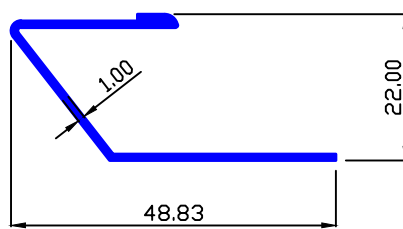

MAAN SEC.-90709

0.796 Kg/Mtr.

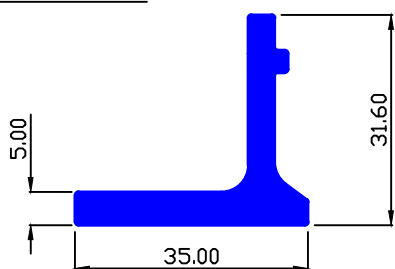

MAAN SEC.-7615

0.163 Kg/Mtr.

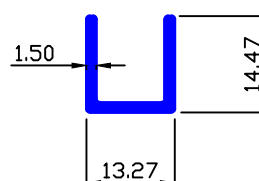

MAAN SEC.-7616

0.219 Kg/Mtr.

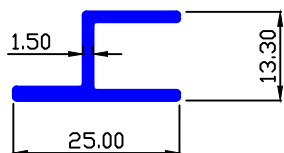

MAAN SEC.-7617

0.496 Kg/Mtr.

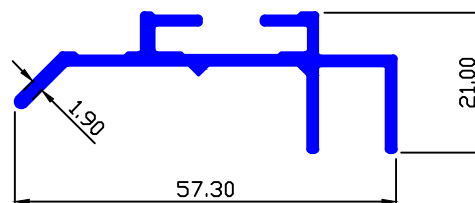

MAAN SEC.-7631

0.188 Kg/Mtr.

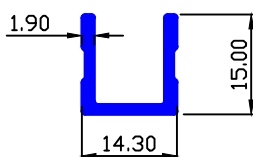

MAAN SEC.-7634

0.662 Kg/Mtr.

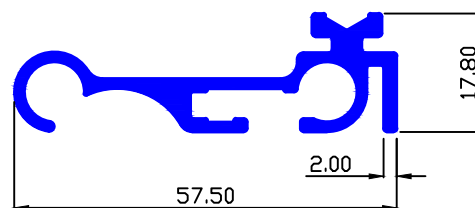

MAAN SEC.-7632

0.210 Kg/Mtr.

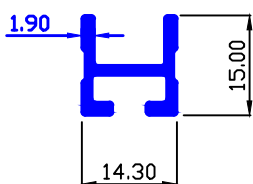

MAAN SEC.-7635

0.425 Kg/Mtr.

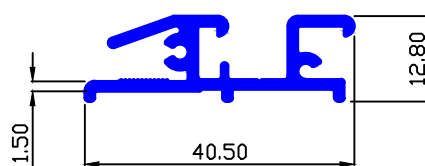



TRANSPORT ROAD

MAAN SEC.-7680

0.525 Kg/Mtr.

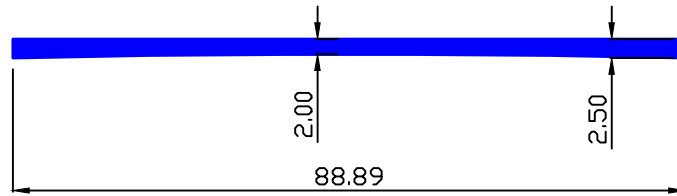

MAAN SEC.-7817

0.253 Kg/Mtr.

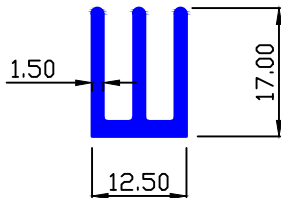

MAAN SEC.-7679

0.093 Kg/Mtr.

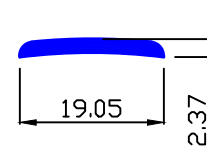

MAAN SEC.-7682

0.632 Kg/Mtr.

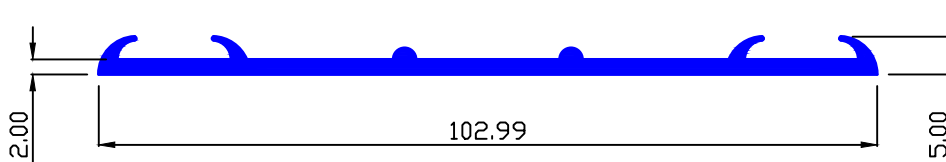

MAAN SEC.-7683

0.813 Kg/Mtr.

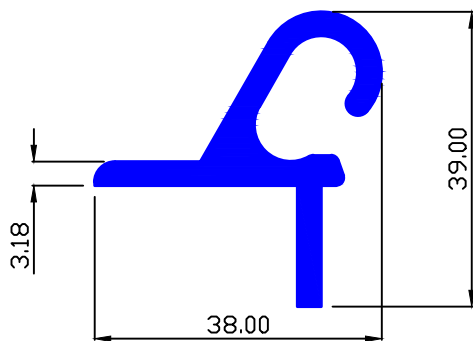

MAAN SEC.-7684

0.843 Kg/Mtr.

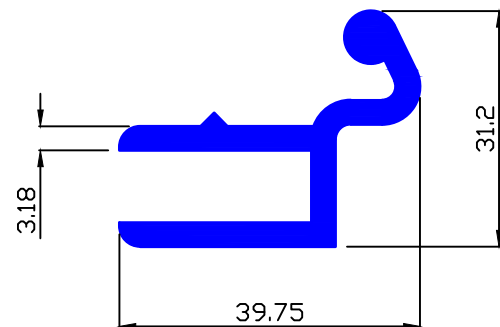

MAAN SEC.-7685

0.300 Kg/Mtr.

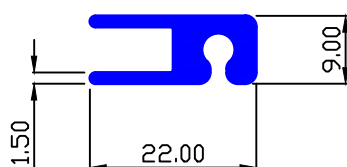

MAAN SEC.-7687

0.755 Kg/Mtr.

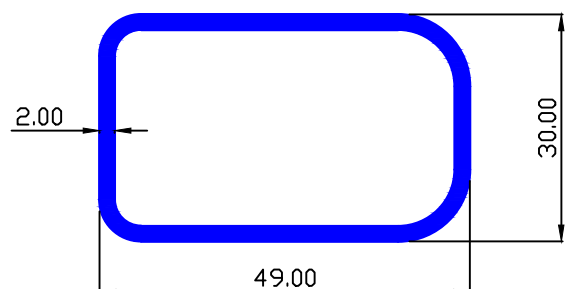



TRANSPORT ROAD

MAAN SEC.-7693

1.501 Kg/Mtr.

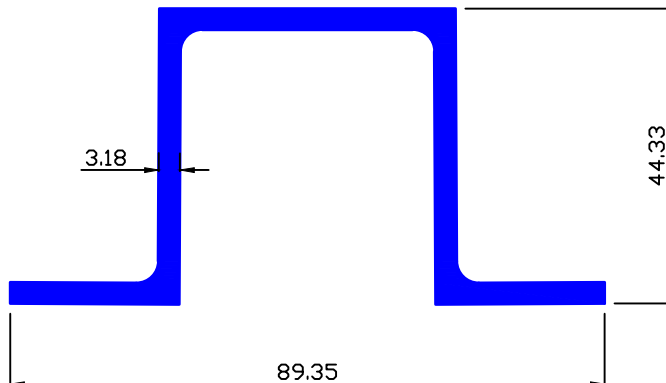

MAAN SEC.-7710

1.698 Kg/Mtr.

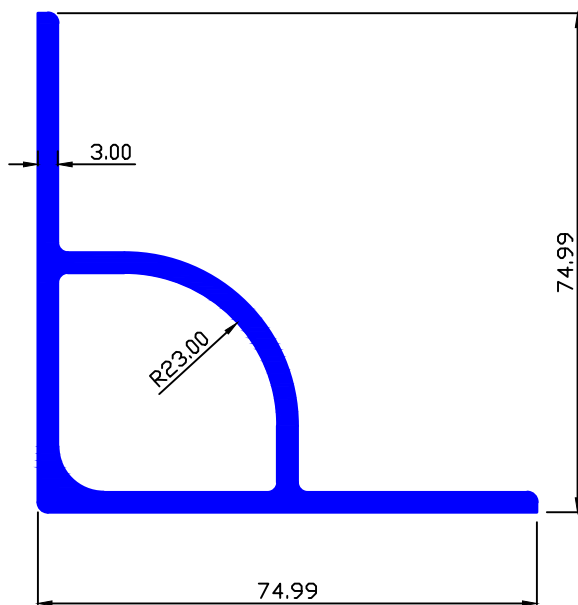

MAAN SEC.-7717

0.314 Kg/Mtr.

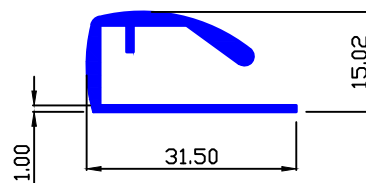

MAAN SEC.-7731

3.948 Kg/Mtr.

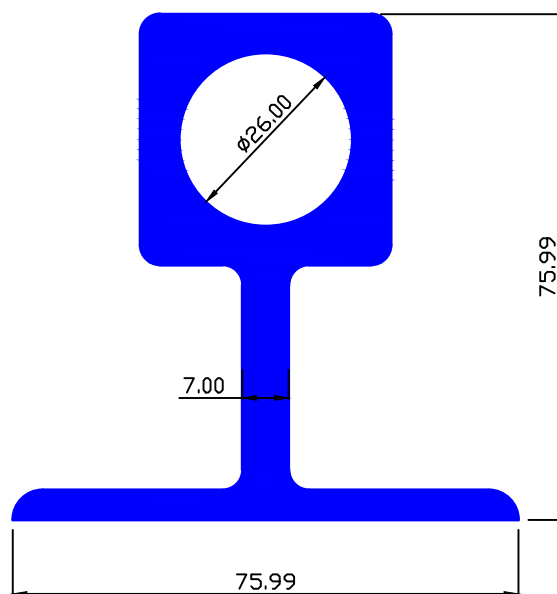

MAAN SEC.-7728

0.354 Kg/Mtr.

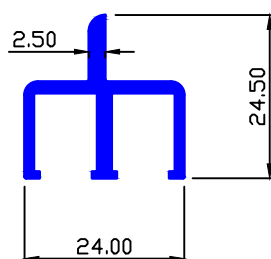



TRANSPORT ROAD

MAAN SEC.-7732

0.517 Kg/Mtr.

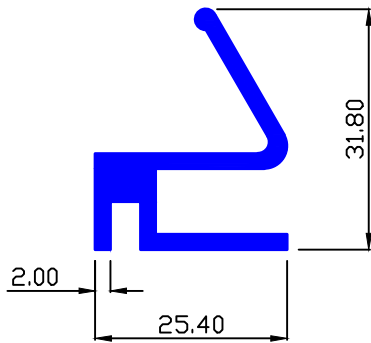

MAAN SEC.-7737

0.176 Kg/Mtr.

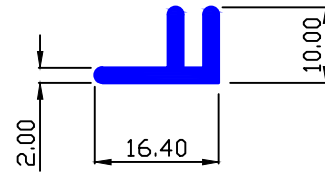

MAAN SEC.-7803

0.432 Kg/Mtr.

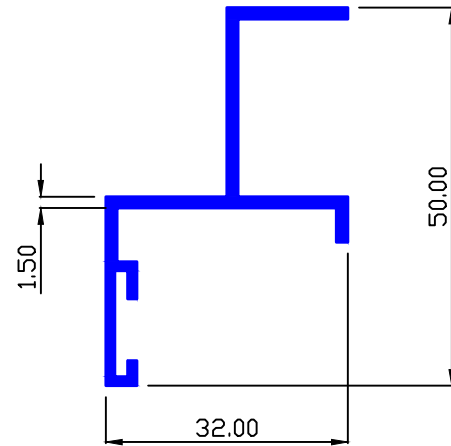

MAAN SEC.-7784

0.611 Kg/Mtr.

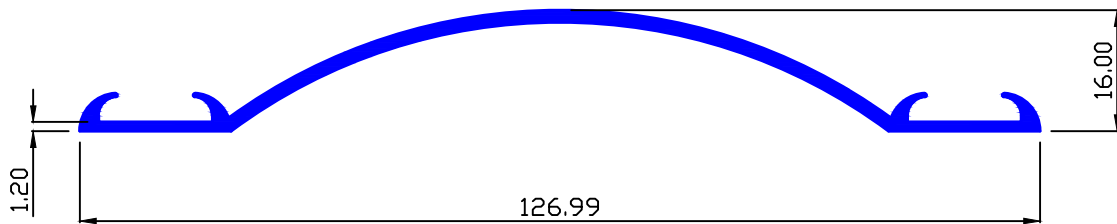

MAAN SEC.-90745

1.167 Kg/Mtr.

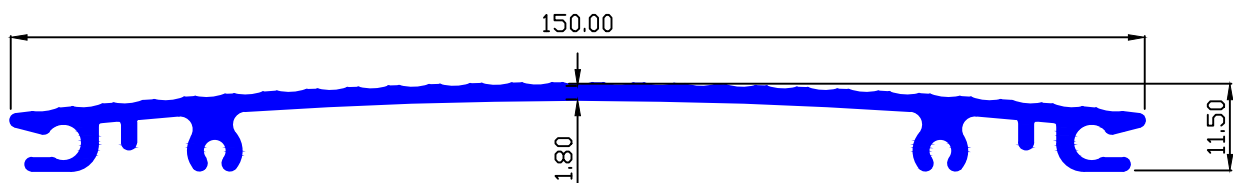



TRANSPORT ROAD

MAAN SEC.-7829

0.310 Kg/Mtr.

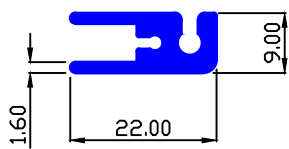

MAAN SEC.-7830

0.456 Kg/Mtr.

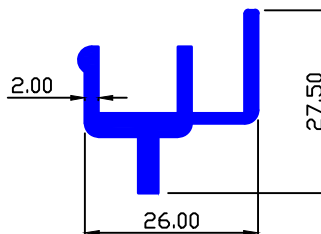

MAAN SEC.-7831

0.572 Kg/Mtr.

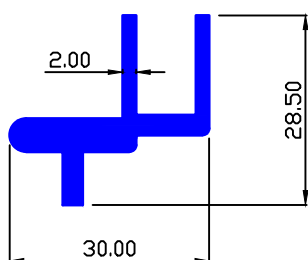

MAAN SEC.-7832

0.327 Kg/Mtr.

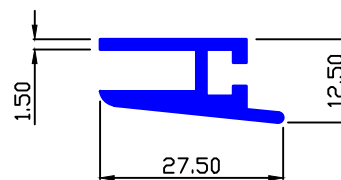

MAAN SEC.-7833

0.163 Kg/Mtr.

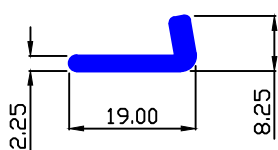

MAAN SEC.-7834

0.533 Kg/Mtr.

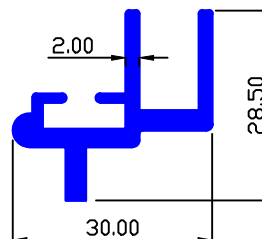

MAAN SEC.-7860

1.440 Kg/Mtr.

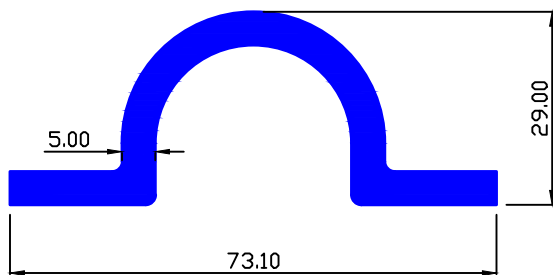

MAAN SEC.-7869

0.165 Kg/Mtr.

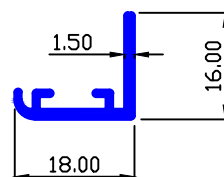

MAAN SEC.-7885

0.948 Kg/Mtr.

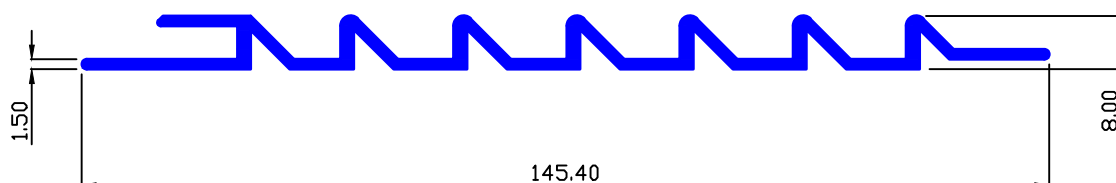



TRANSPORT ROAD

MAAN SEC.-7945

0.241 Kg/Mtr.

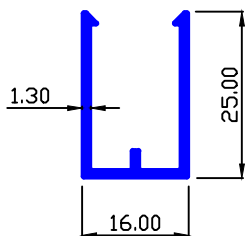

MAAN SEC.-7960

0.445 Kg/Mtr.

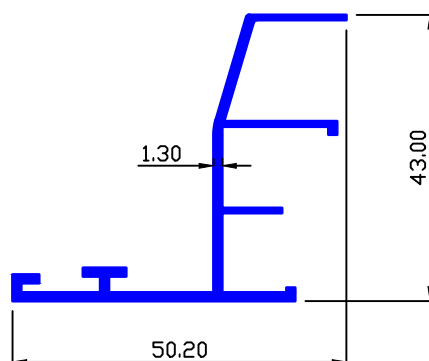

MAAN SEC.-7970

0.161 Kg/Mtr.

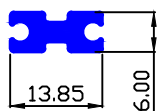

MAAN SEC.-7971

1.915 Kg/Mtr.

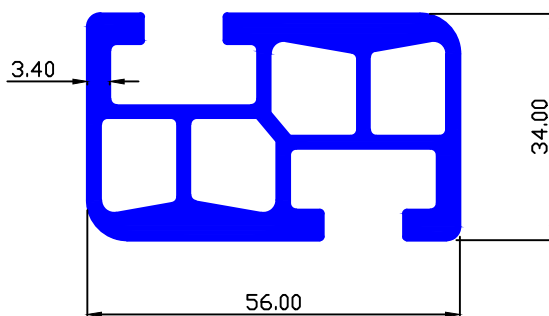

MAAN SEC.-7994

0.128 Kg/Mtr.

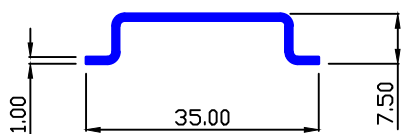

MAAN SEC.-7995

0.193 Kg/Mtr.

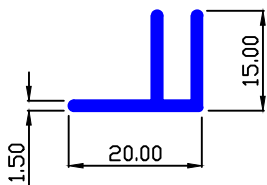

MAAN SEC.-89789

0.272 Kg/Mtr.

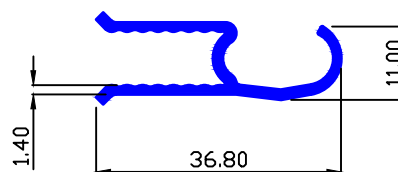

MAAN SEC.-8116

0.171 Kg/Mtr.

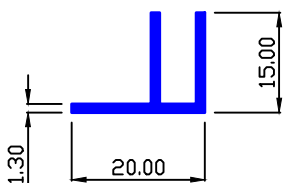

MAAN SEC.-8642

0.991 Kg/Mtr.

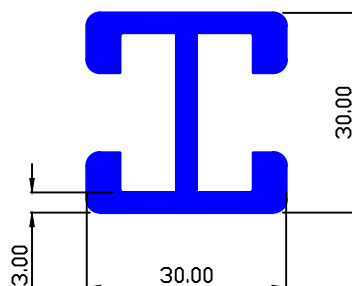

MAAN SEC.-8643

0.563 Kg/Mtr.

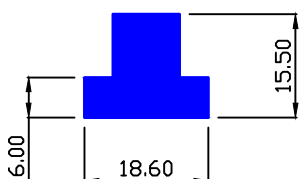



TRANSPORT ROAD

MAAN SEC.-8669

0.171 Kg/Mtr.

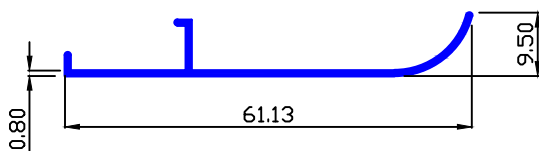

MAAN SEC.-8670

0.266 Kg/Mtr.

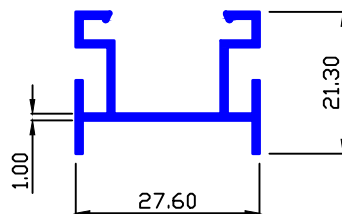

MAAN SEC.-8671

0.164 Kg/Mtr.

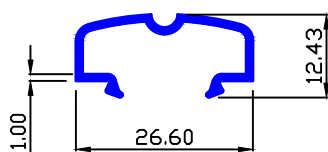

MAAN SEC.-8871

0.772 Kg/Mtr.

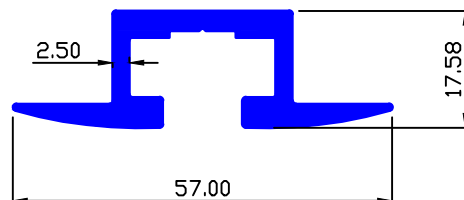

MAAN SEC.-8884

0.577 Kg/Mtr.

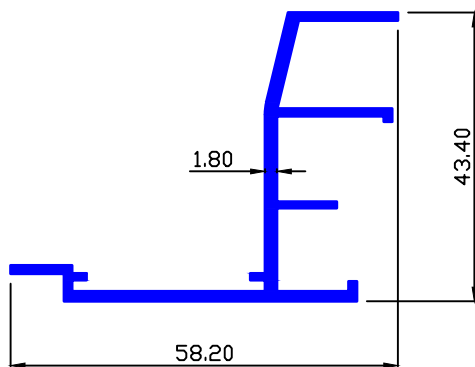

MAAN SEC.-8885

0.545 Kg/Mtr.

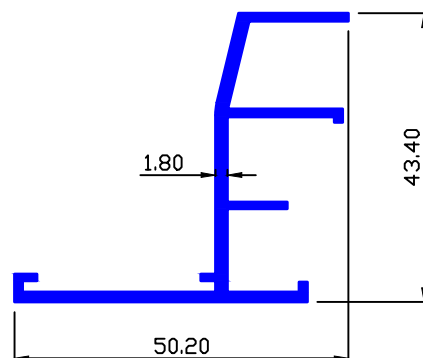

MAAN SEC.-8886

0.356 Kg/Mtr.

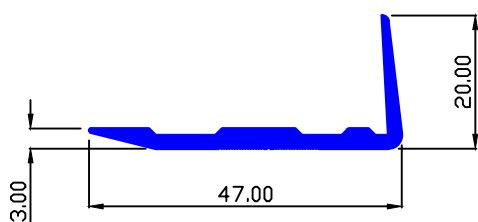

MAAN SEC.-8965

0.199 Kg/Mtr.

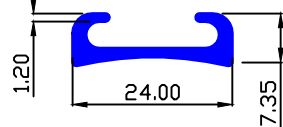

MAAN SEC.-8966

0.244 Kg/Mtr.

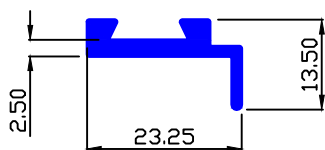

MAAN SEC.-8967

0.577 Kg/Mtr.

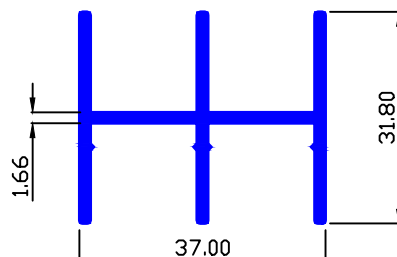



TRANSPORT ROAD

MAAN SEC.-8968

0.595 Kg/Mtr.

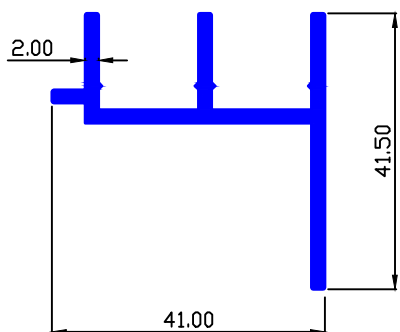

MAAN SEC.-8969

0.235 Kg/Mtr.

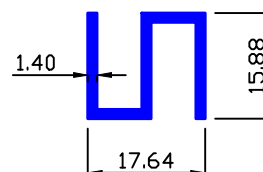

MAAN SEC.-8971

0.521 Kg/Mtr.

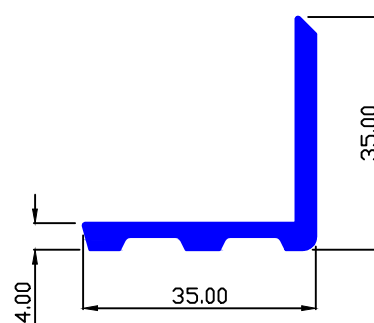

MAAN SEC.-8970

0.236 Kg/Mtr.

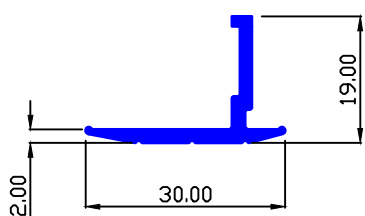

MAAN SEC.-8973

0.881 Kg/Mtr.

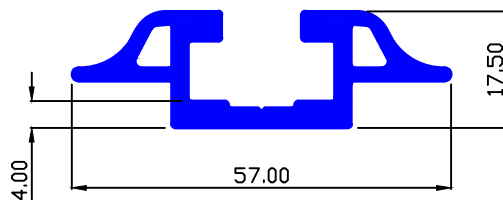

MAAN SEC.-8972

0.206 Kg/Mtr.

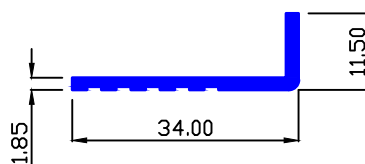

MAAN SEC.-8998

1.449 Kg/Mtr.

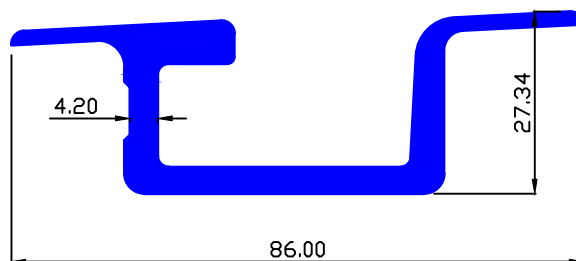

MAAN SEC.-8991

0.441 Kg/Mtr.

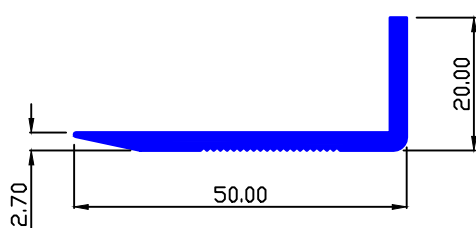

MAAN SEC.-9305

0.390 Kg/Mtr.

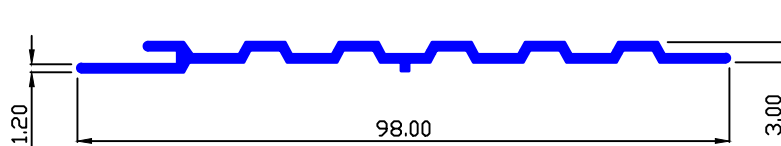



TRANSPORT ROAD

MAAN SEC.-89029

0.676 Kg/Mtr.

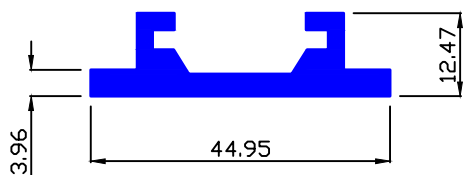

MAAN SEC.-89030

1.243 Kg/Mtr.

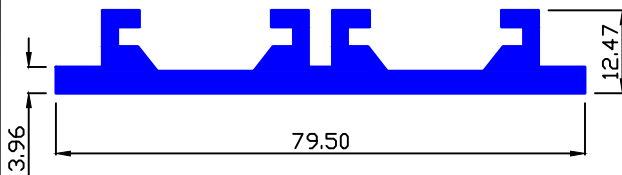

MAAN SEC.-89199

0.394 Kg/Mtr.

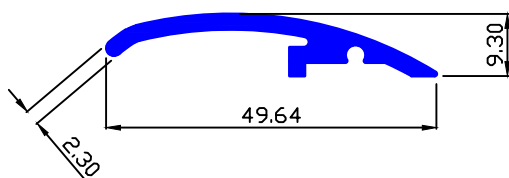

MAAN SEC.-89217

0.206 Kg/Mtr.

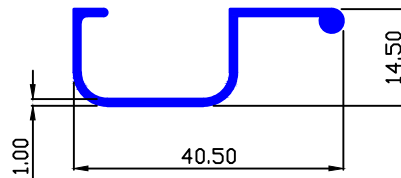

MAAN SEC.-89218

0.182 Kg/Mtr.

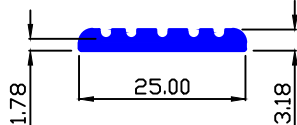

MAAN SEC.-89256

1.391 Kg/Mtr.

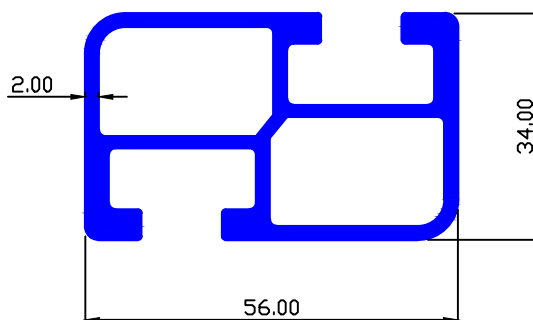

MAAN SEC.-89302

0.373 Kg/Mtr.

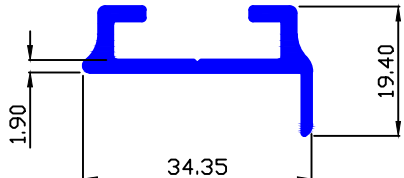

MAAN SEC.-89329

2.935 Kg/Mtr.

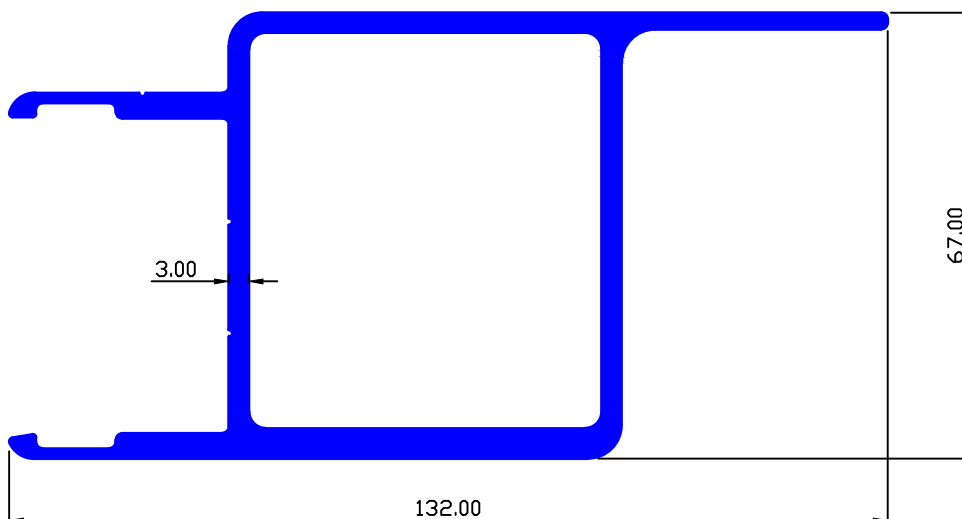



TRANSPORT ROAD

MAAN SEC.-89330

3.072 Kg/Mtr.

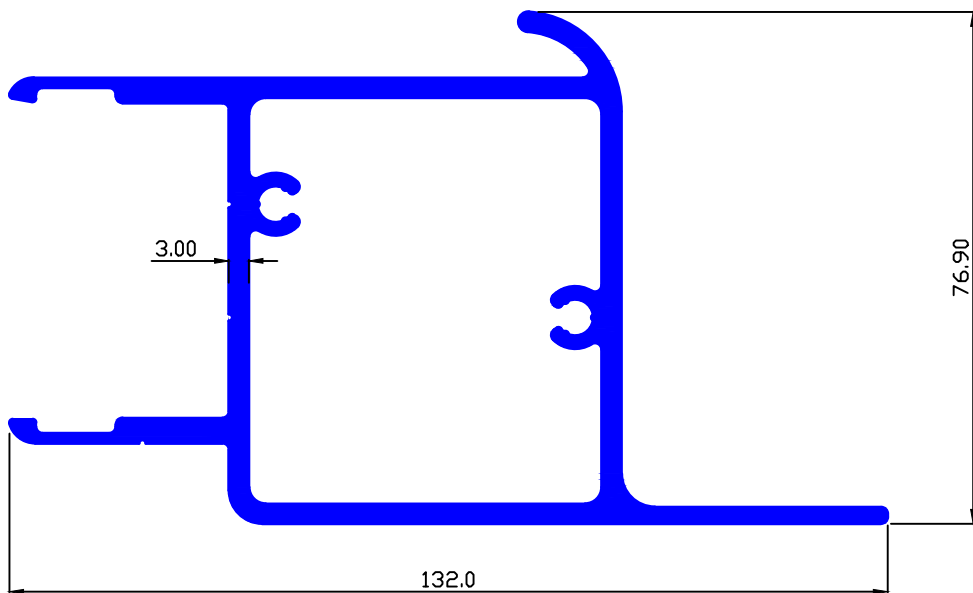

MAAN SEC.-89446

1.173 Kg/Mtr.

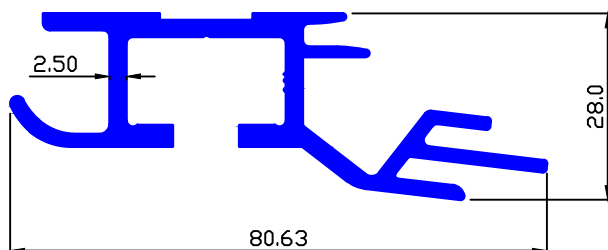

MAAN SEC.-89453

0.670 Kg/Mtr.

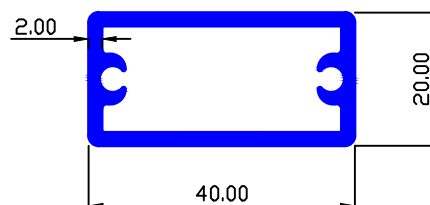

MAAN SEC.-89454

1.030 Kg/Mtr.

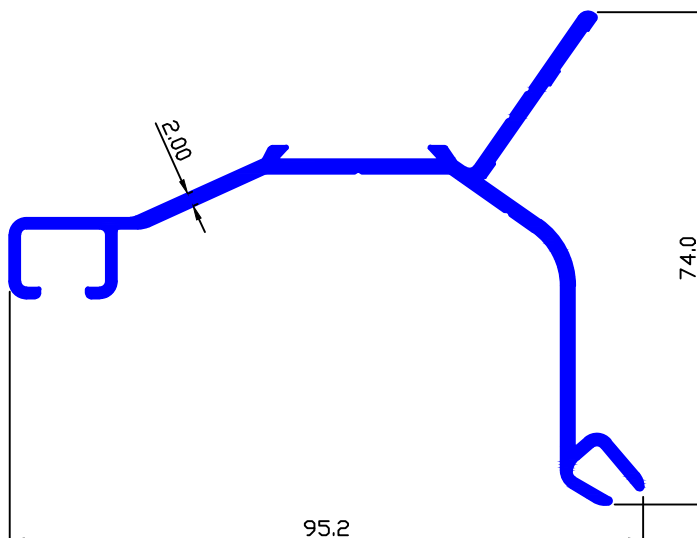



TRANSPORT ROAD

MAAN SEC.-89455

0.390 Kg/Mtr.

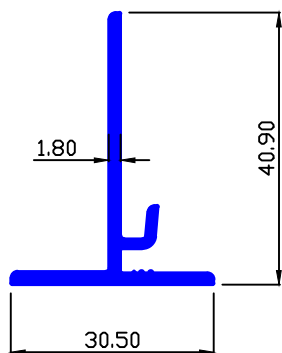

MAAN SEC.-89467

0.625 Kg/Mtr.

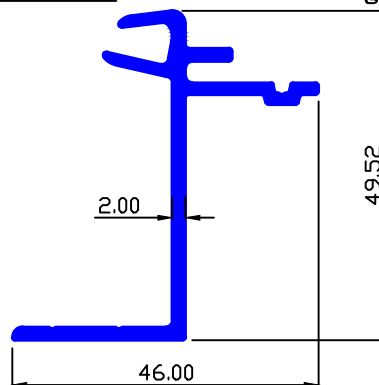

MAAN SEC.-89456

1.400 Kg/Mtr.

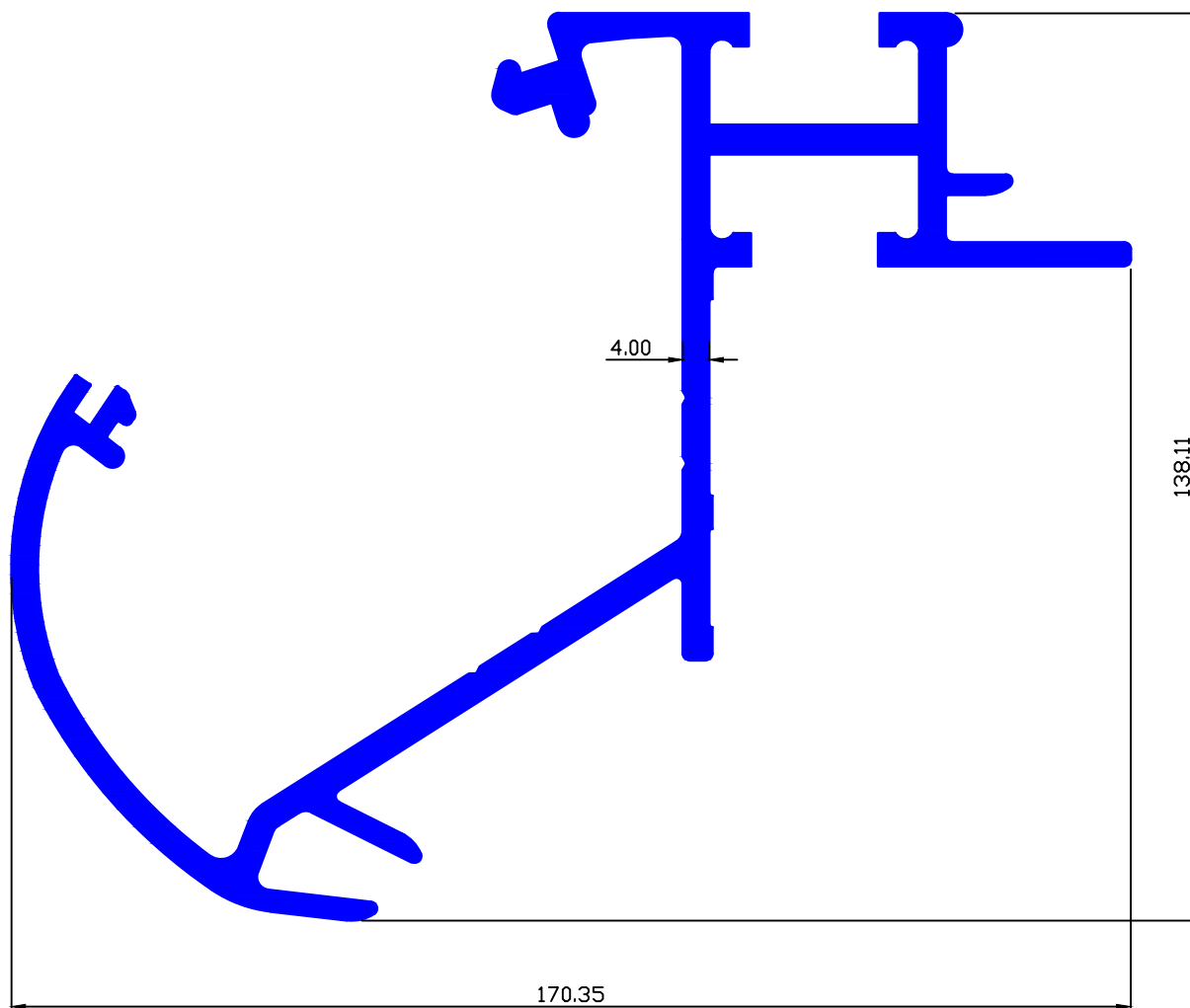



TRANSPORT ROAD

MAAN SEC.-89473 0.711 Kg/Mtr.

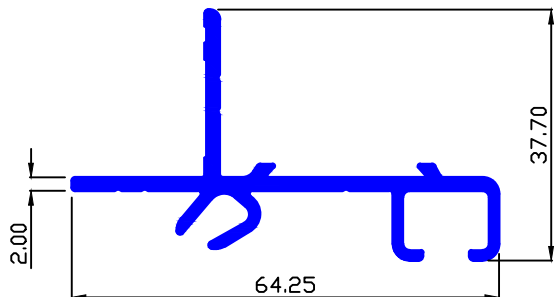

MAAN SEC.-89502 0.103 Kg/Mtr.

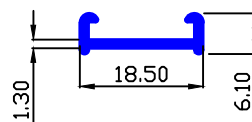

MAAN SEC.-89586 0.450 Kg/Mtr.

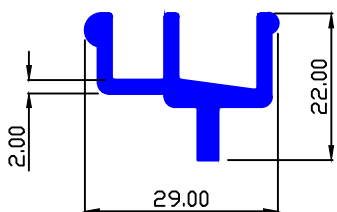

MAAN SEC.-89553 0.542 Kg/Mtr.

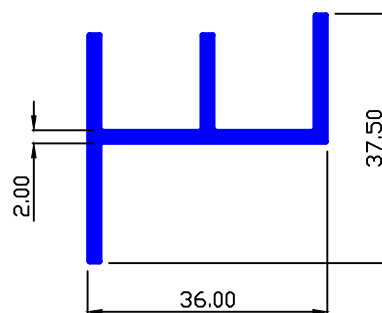

MAAN SEC.-89590

2.318 Kg/Mtr.

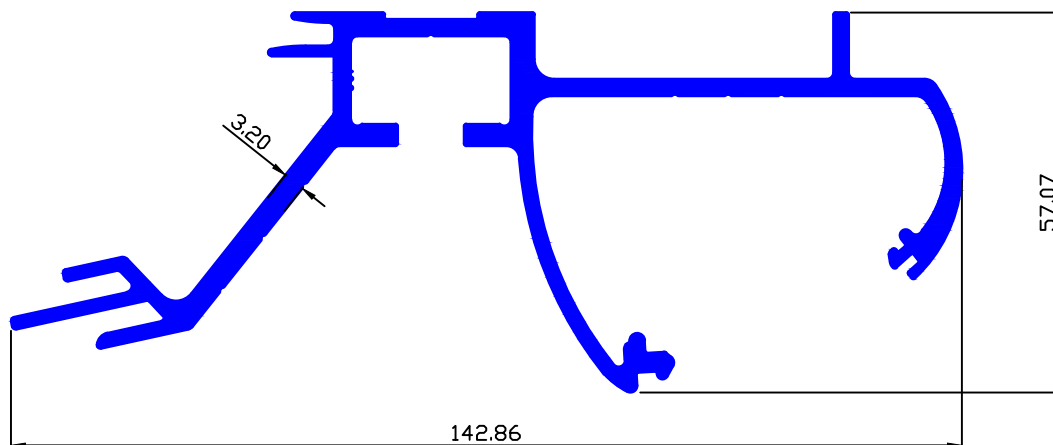

MAAN SEC.-89591 0.717 Kg/Mtr.

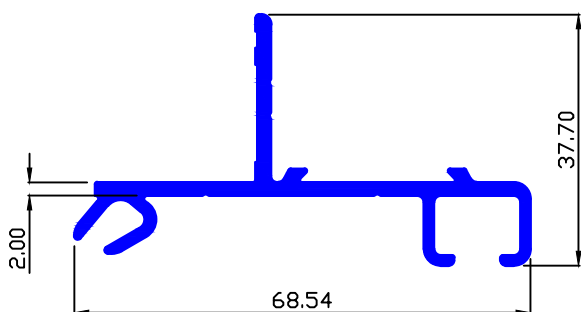

MAAN SEC.-89592 1.029 Kg/Mtr.

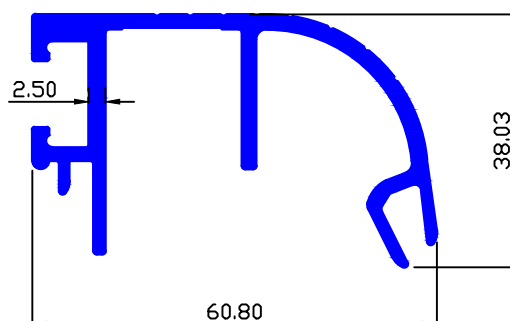



TRANSPORT ROAD

MAAN SEC.-89594

0.717 Kg/Mtr.

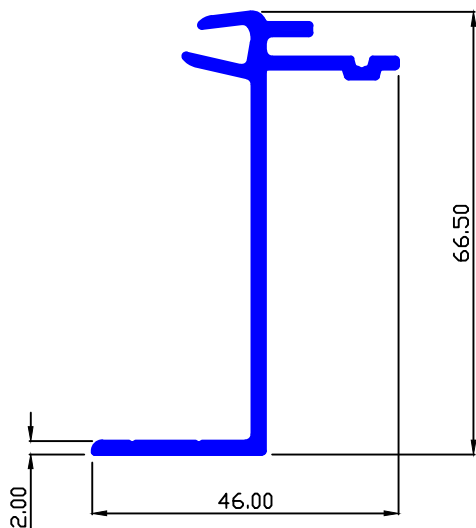

MAAN SEC.-89598

0.806 Kg/Mtr.

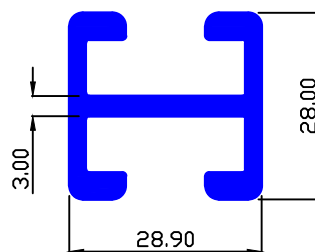

MAAN SEC.-89608

0.243 Kg/Mtr.

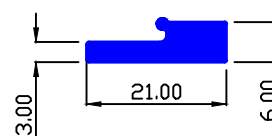

MAAN SEC.-89609

0.361 Kg/Mtr.

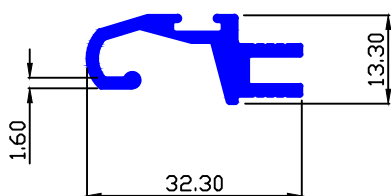

MAAN SEC.-89610

0.254 Kg/Mtr.

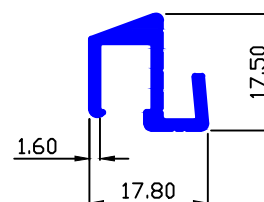

MAAN SEC.-89611

0.311 Kg/Mtr.

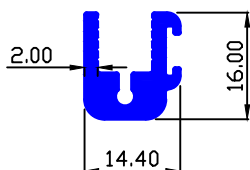

MAAN SEC.-89613

0.482 Kg/Mtr.

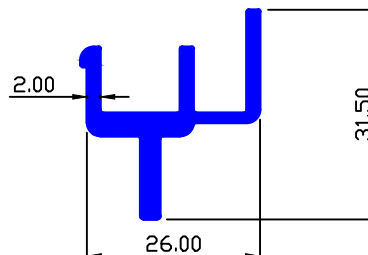

MAAN SEC.-89612

0.411 Kg/Mtr.

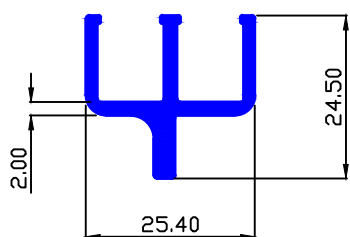

MAAN SEC.-89629

0.181 Kg/Mtr.

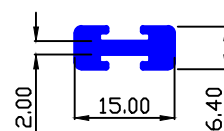



TRANSPORT ROAD

MAAN SEC.-89630

0.412 Kg/Mtr.

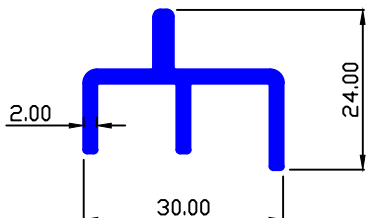

MAAN SEC.-89710

0.350 Kg/Mtr.

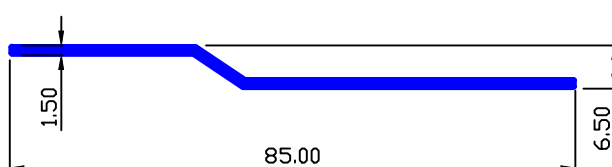

MAAN SEC.-89631

0.473 Kg/Mtr.

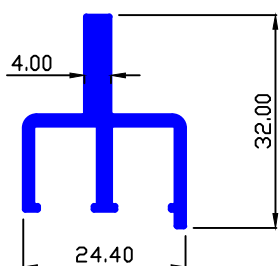

MAAN SEC.-89698

0.446 Kg/Mtr.

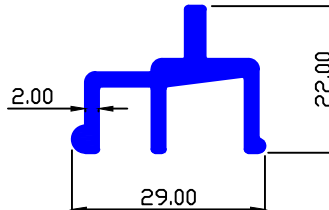

MAAN SEC.-89699

0.254 Kg/Mtr.

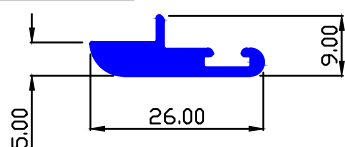

MAAN SEC.-89700

0.249 Kg/Mtr.

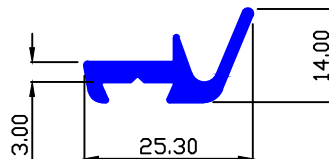

MAAN SEC.-89701

0.688 Kg/Mtr.

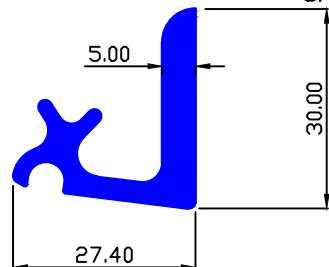

MAAN SEC.-89702

0.459 Kg/Mtr.

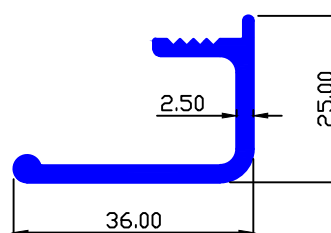

MAAN SEC.-89704

1.043 Kg/Mtr.

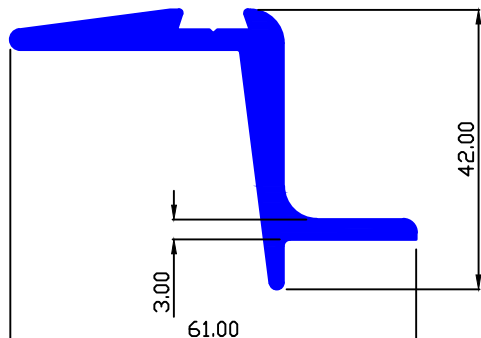

MAAN SEC.-89703

1.223 Kg/Mtr.

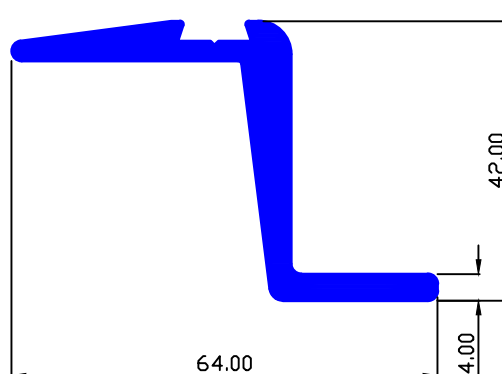



TRANSPORT ROAD

MAAN SEC.-89705

0.716 Kg/Mtr.

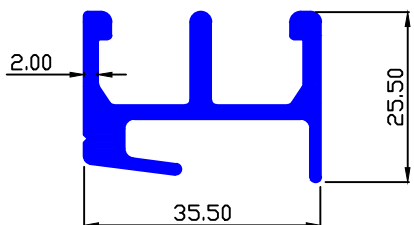

MAAN SEC.-89706

0.264 Kg/Mtr.

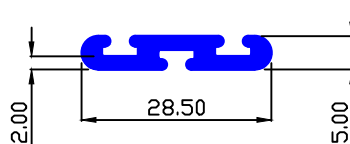

MAAN SEC.-89707

0.307 Kg/Mtr.

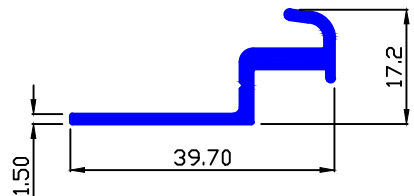

MAAN SEC.-89708

0.223 Kg/Mtr.

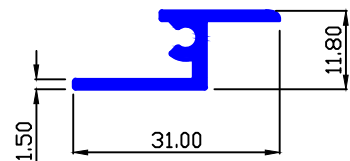

MAAN SEC.-89709

0.233 Kg/Mtr.

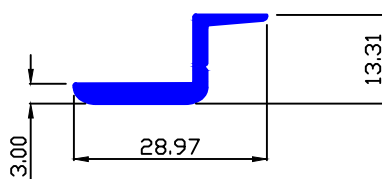

MAAN SEC.-89719

0.310 Kg/Mtr.

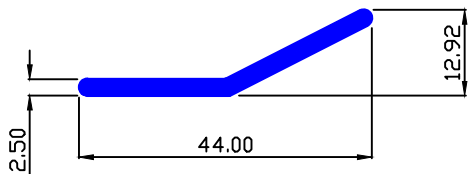

MAAN SEC.-89799

1.289 Kg/Mtr.

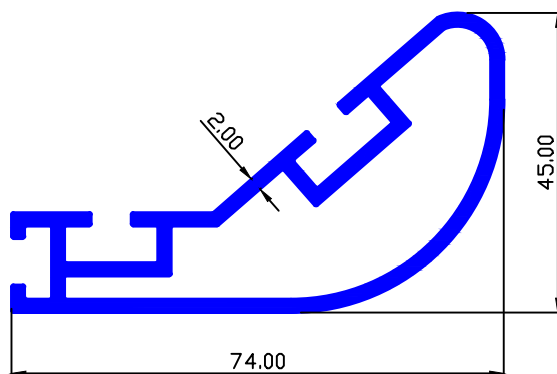

MAAN SEC.-90744

1.188 Kg/Mtr.

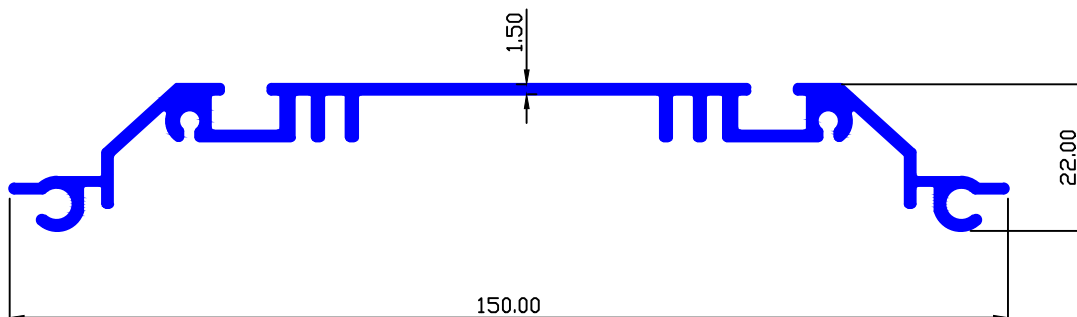



TRANSPORT ROAD

MAAN SEC.-89798

0.354 Kg/Mtr.

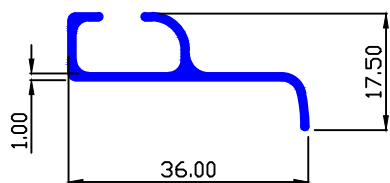

MAAN SEC.-89806

0.631 Kg/Mtr.

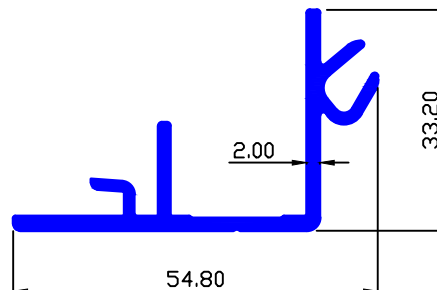

MAAN SEC.-89807

0.841 Kg/Mtr.

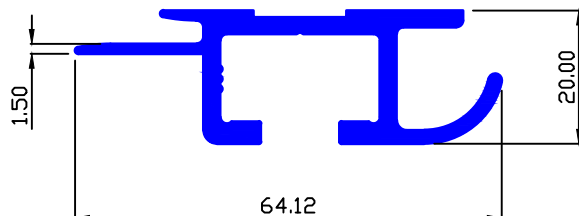

MAAN SEC.-89818

0.374 Kg/Mtr.

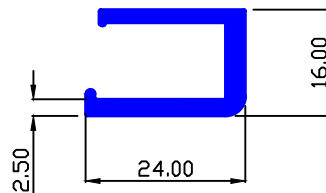

MAAN SEC.-89859

1.124 Kg/Mtr.

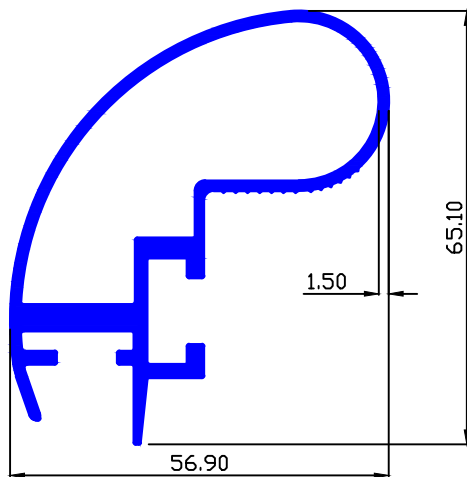

MAAN SEC.-89860

0.471 Kg/Mtr.

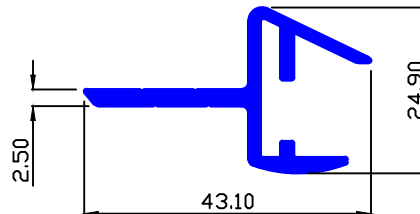

MAAN SEC.-89861

0.134 Kg/Mtr.

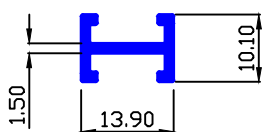

MAAN SEC.-89863

0.916 Kg/Mtr.

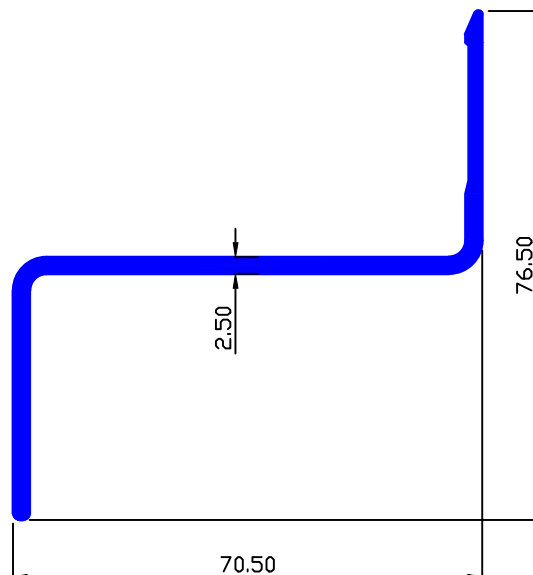



TRANSPORT ROAD

MAAN SEC.-89864

0.552 Kg/Mtr.

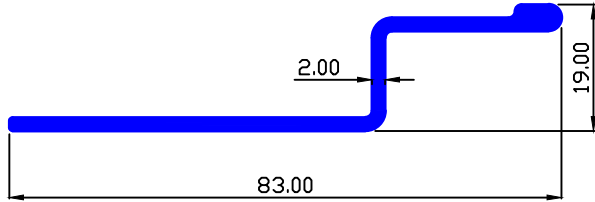

MAAN SEC.-89884

1.311 Kg/Mtr.

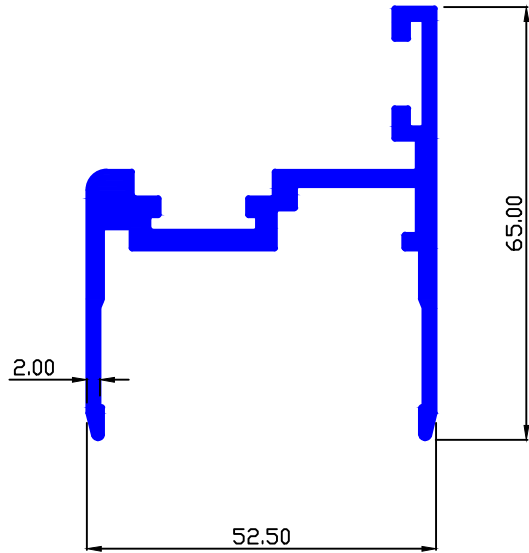

MAAN SEC.-89885

0.971 Kg/Mtr.

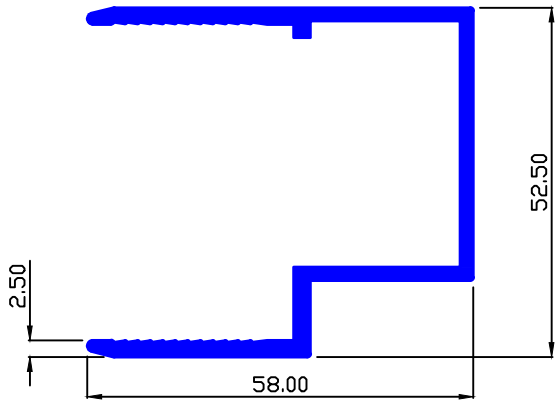

MAAN SEC.-89886

2.859 Kg/Mtr.

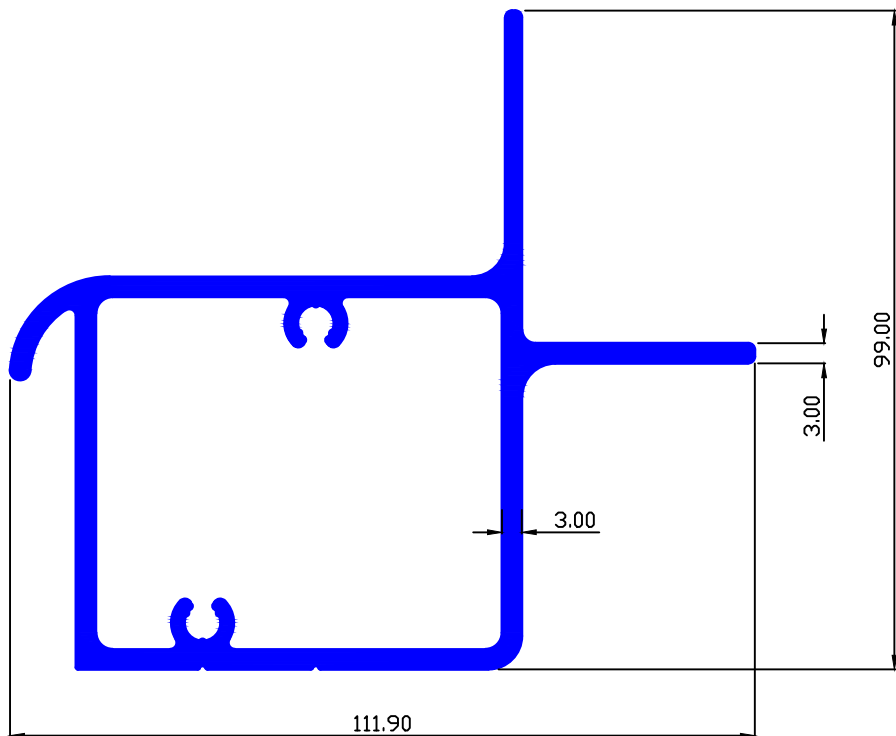



TRANSPORT ROAD

MAAN SEC.-89887

2.046 Kg/Mtr.

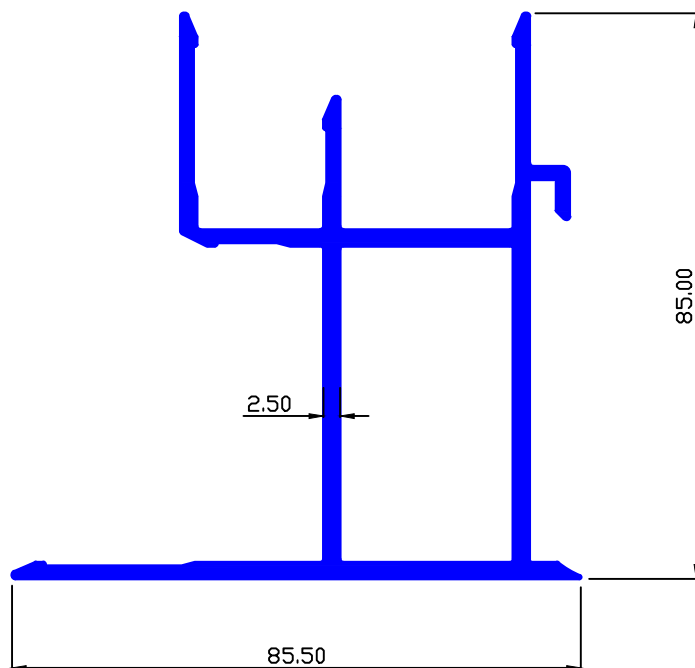

MAAN SEC.-90708

1.535 Kg/Mtr.

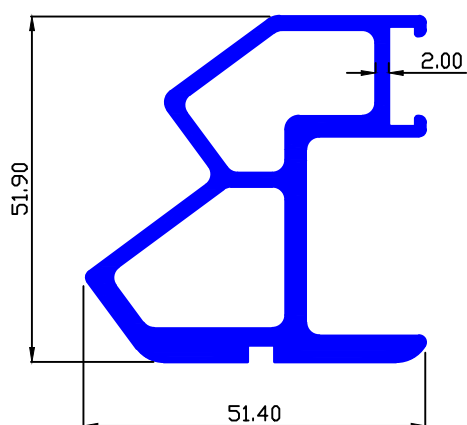



**TRANSPORT  
ROAD**

MAAN SEC.-89927

0.484 Kg/Mtr.

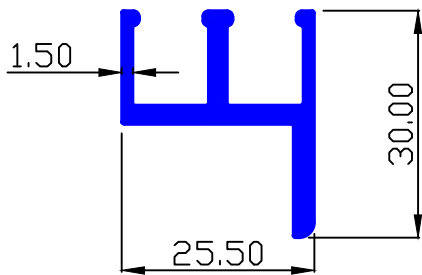

MAAN SEC.-89973

1.410 Kg/Mtr.

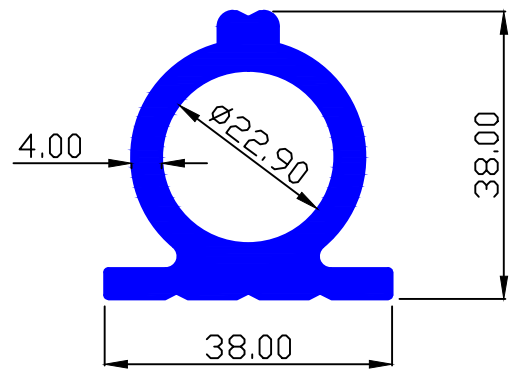

MAAN SEC.-89931

0.374 Kg/Mtr.

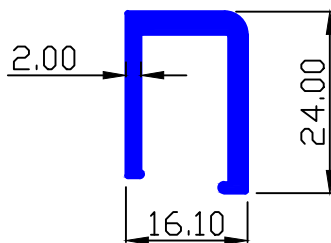

MAAN SEC.-89974

1.104 Kg/Mtr.

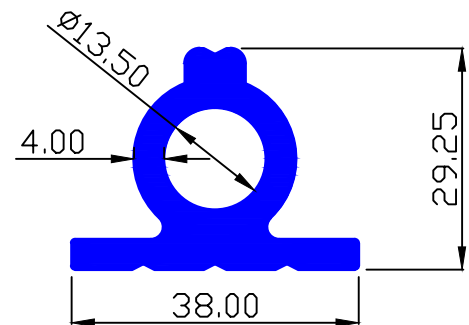

MAAN SEC.-89972

2.168 Kg/Mtr.

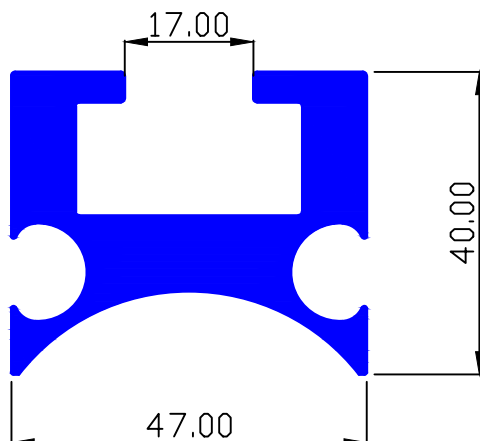

MAAN SEC.-90035

0.632 Kg/Mtr.

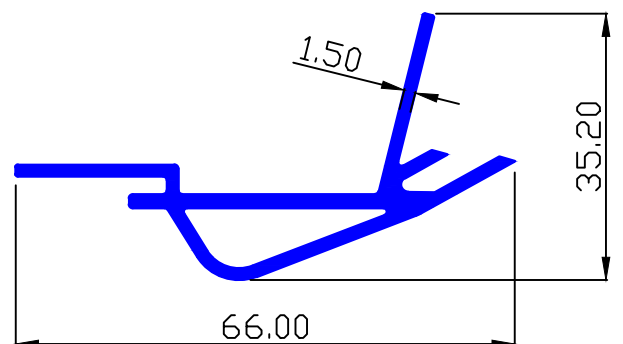

MAAN SEC.-90185

0.178 Kg/Mtr.

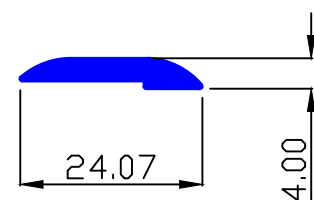



**TRANSPORT  
ROAD**

**MAAN SEC.-90034**

**1.213 Kg/Mtr.**

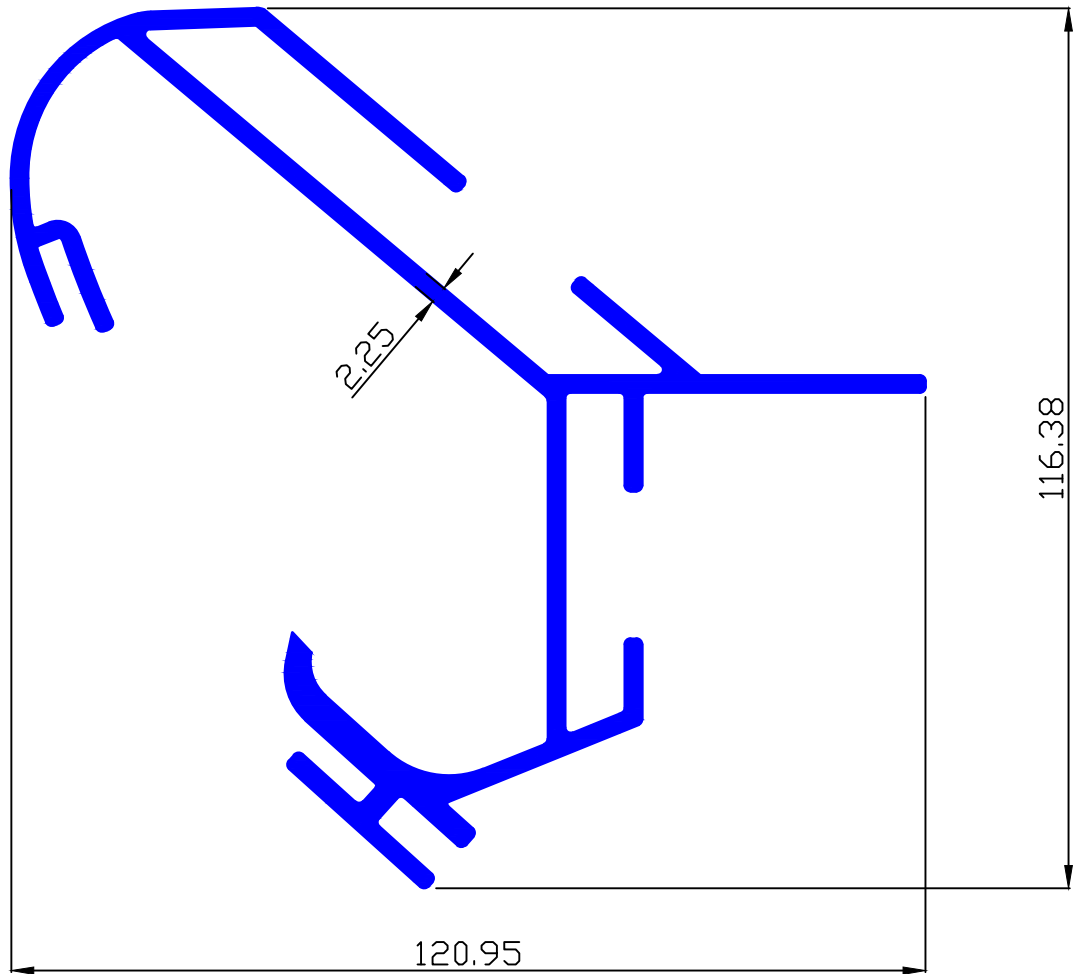

**MAAN SEC.-90182**

**1.263 Kg/Mtr.**

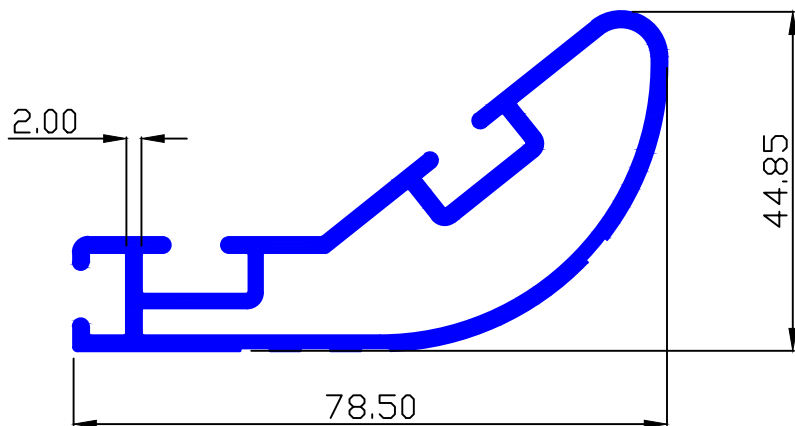



**TRANSPORT ROAD**

**MAAN SEC.-90188** 0.236 Kg/Mtr.

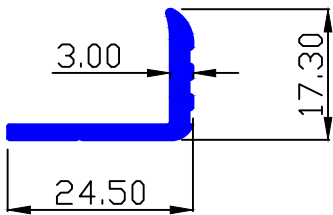

**MAAN SEC.-90252** 0.154 Kg/Mtr.

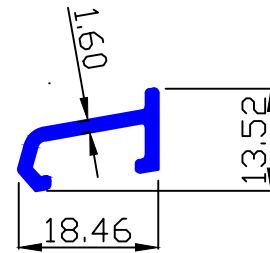

**MAAN SEC.-90199** 0.478 Kg/Mtr.

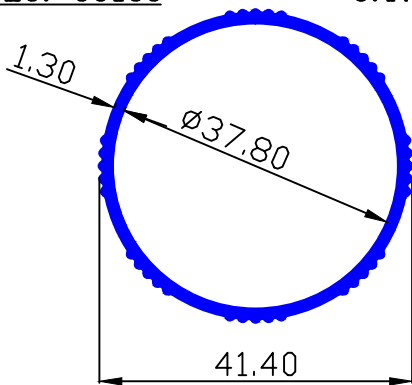

**MAAN SEC.-90241** 0.449 Kg/Mtr.

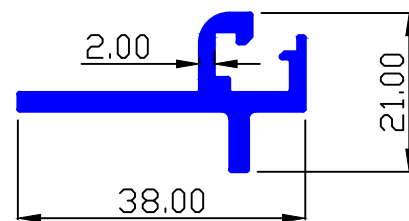

WEIGHT RANGE : 0.415 TO 480 KG/MTR

**MAAN SEC.-90227** 0.281 Kg/Mtr.

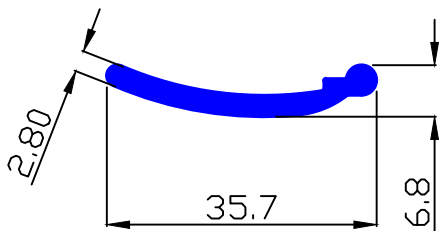

**MAAN SEC.-90242** 0.385 Kg/Mtr.

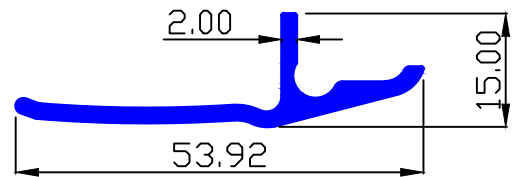

WEIGHT RANGE : 0.360 TO 0.420 KG/MTR

**MAAN SEC.-90234** 0.177 Kg/Mtr.

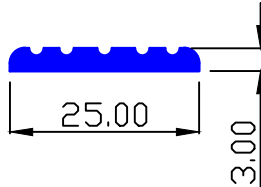

**MAAN SEC.-90243** 0.305 Kg/Mtr.

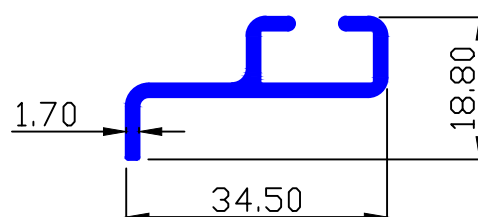

WEIGHT RANGE : 0.284 TO 0.327 Kg/MTR.

**MAAN SEC.-90235** 0.348 Kg/Mtr.

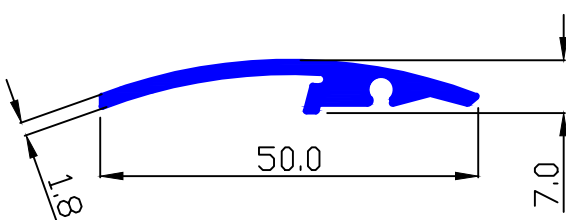



**TRANSPORT  
ROAD**

MAAN SEC.-90266

0.458 Kg/Mtr.

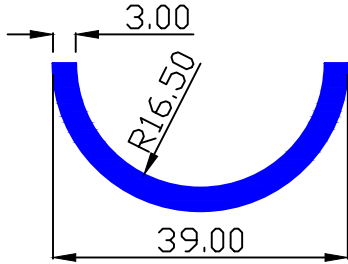

MAAN SEC.-90289

0.295 Kg/Mtr.

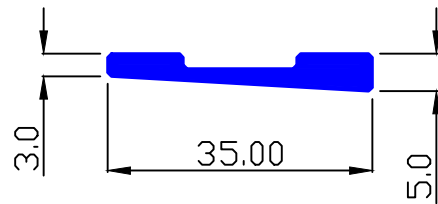

MAAN SEC.-90267

0.648 Kg/Mtr.

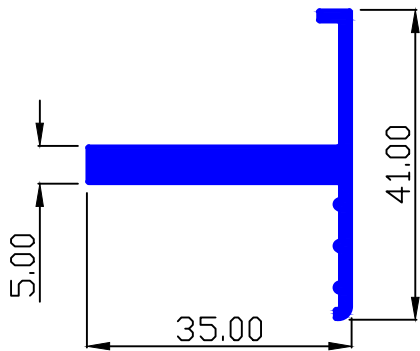

MAAN SEC.-90290

0.558 Kg/Mtr.

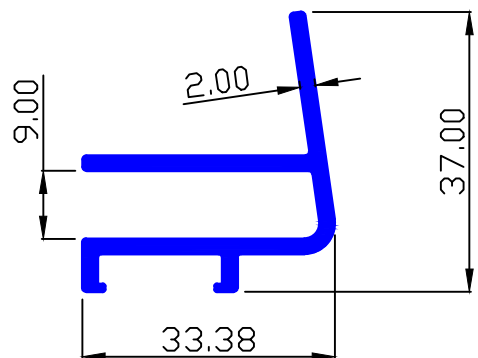

MAAN SEC.-90268

0.428 Kg/Mtr.

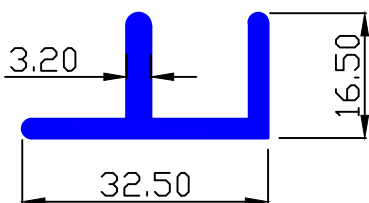

MAAN SEC.-90358

0.258 Kg/Mtr.

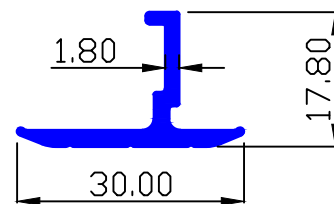

MAAN SEC.-90269

0.698 Kg/Mtr.

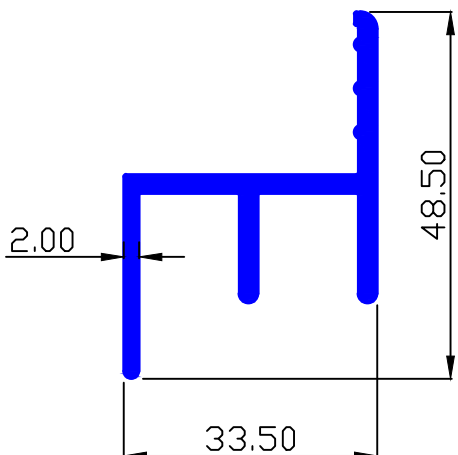



**TRANSPORT  
ROAD**

MAAN SEC.-90391

0.413 Kg/Mtr.

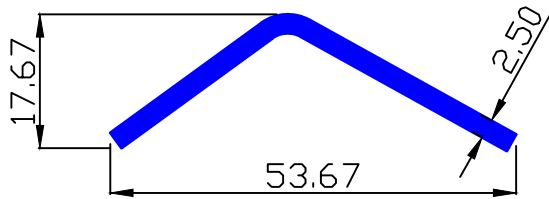

MAAN SEC.-90392

0.333 Kg/Mtr.

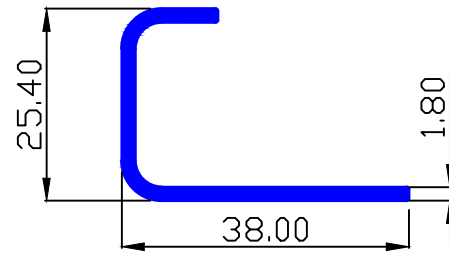

MAAN SEC.-90390

0.524 Kg/Mtr.

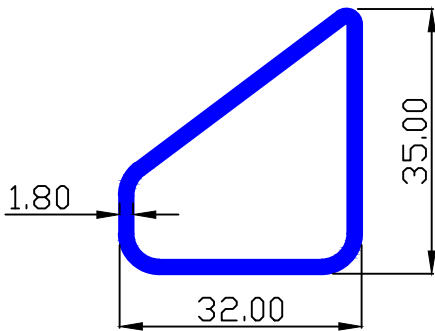

MAAN SEC.-90422

0.538 Kg/Mtr.

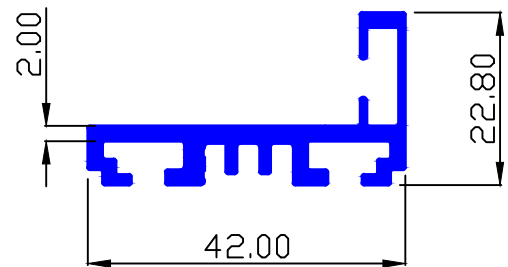

MAAN SEC.-90423

0.253 Kg/Mtr.

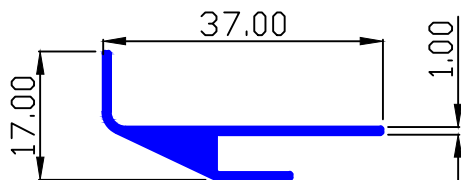

MAAN SEC.-90490

0.823 Kg/Mtr.

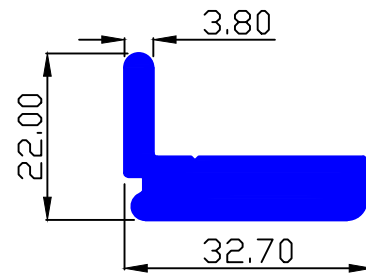

MAAN SEC.-90489

0.878 Kg/Mtr.

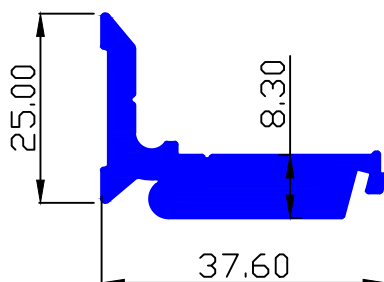

MAAN SEC.-90491

0.136 Kg/Mtr.

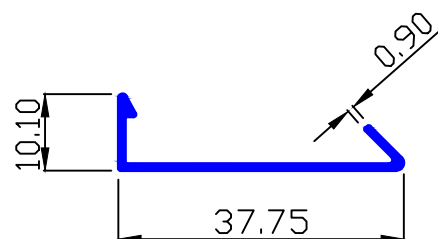



**TRANSPORT ROAD**

**MAAN SEC.-90492**

**2.058 Kg/Mtr.**

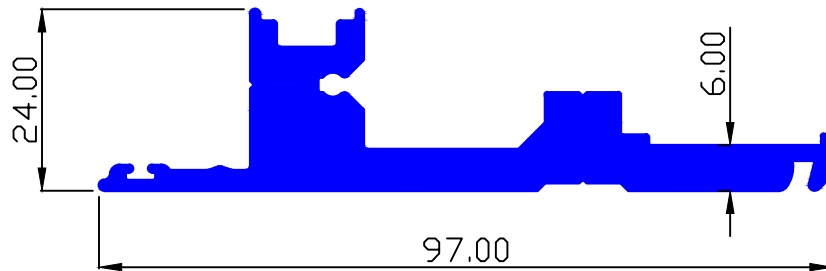

**MAAN SEC.-90493**

**1.466 Kg/Mtr.**

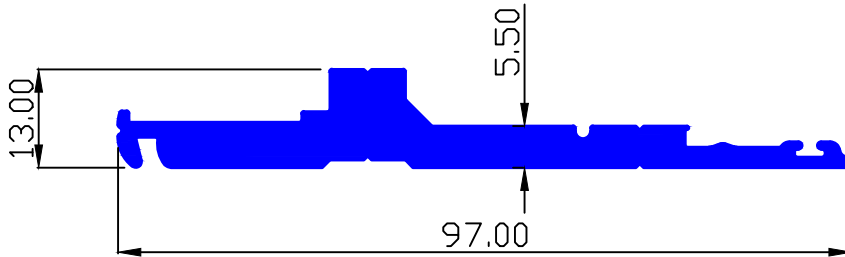

**MAAN SEC.-90494**

**0.295 Kg/Mtr.**

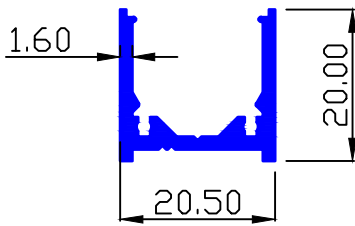

**MAAN SEC.-90496**

**0.726 Kg/Mtr.**

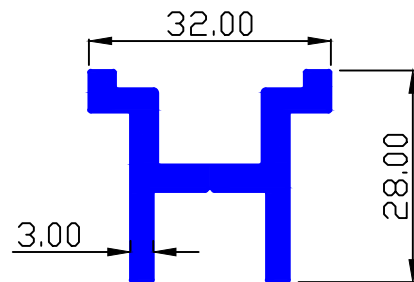

**MAAN SEC.-90497**

**0.602 Kg/Mtr.**

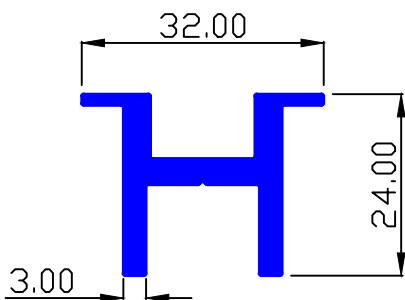

**MAAN SEC.-90510**

**0.605 Kg/Mtr.**

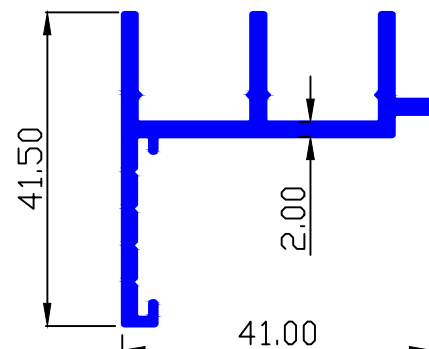



**TRANSPORT ROAD**

**MAAN SEC.-90495**

**0.531 Kg/Mtr.**

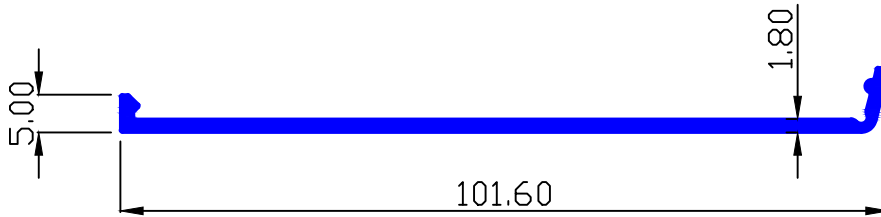

**MAAN SEC.-90535**

**1.177 Kg/Mtr.**

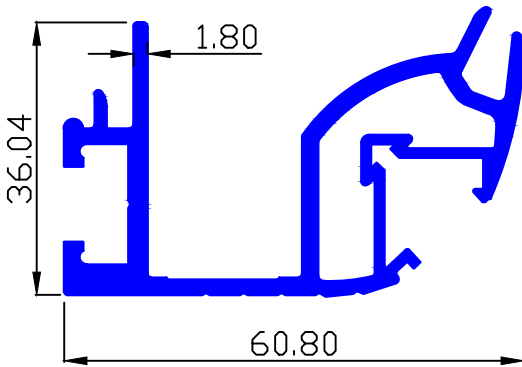

**MAAN SEC.-90536**

**1.044 Kg/Mtr.**

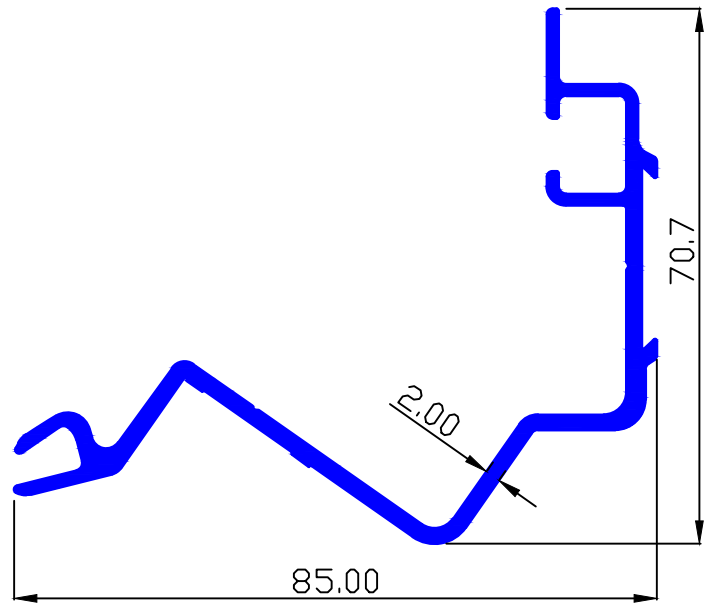

**MAAN SEC.-90538**

**0.259 Kg/Mtr.**

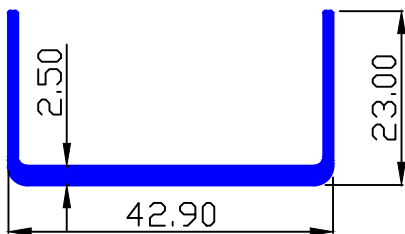

**MAAN SEC.-90541**

**0.852 Kg/Mtr.**

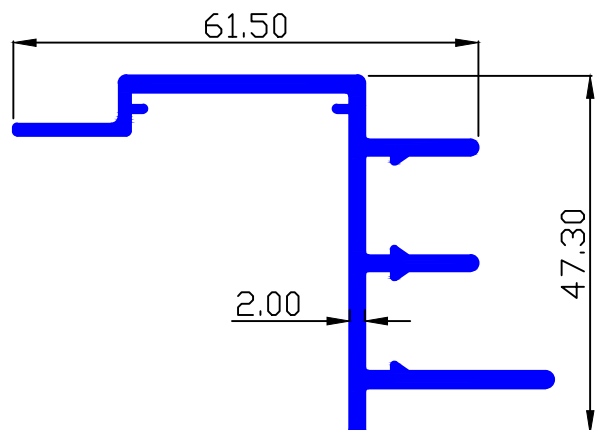

**MAAN SEC.-90537**

**0.771 Kg/Mtr.**

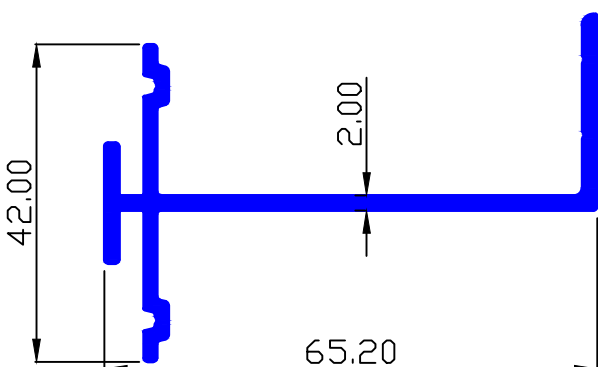



**TRANSPORT  
ROAD**

MAAN SEC.-90588

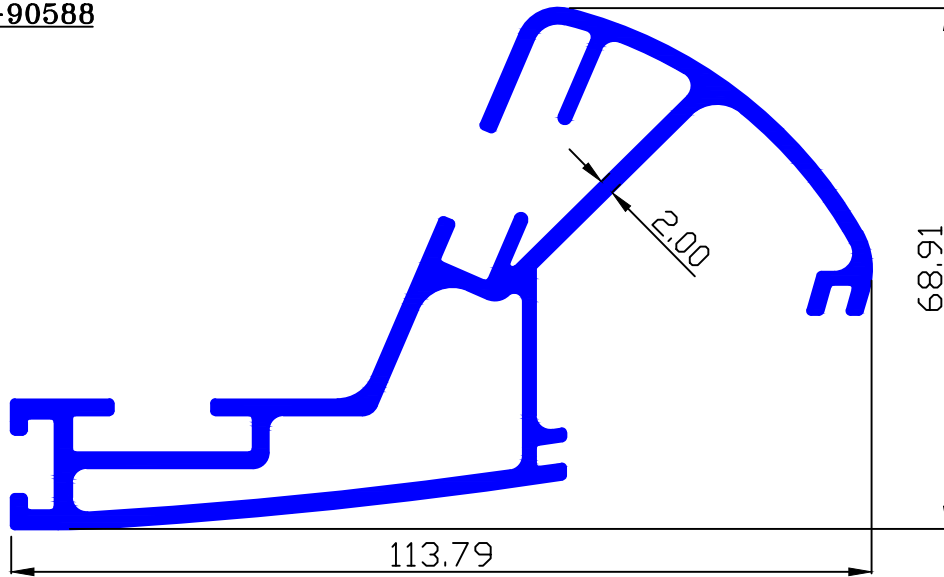

2.043 Kg/Mtr.

MAAN SEC.-90571

1.805 Kg/Mtr.

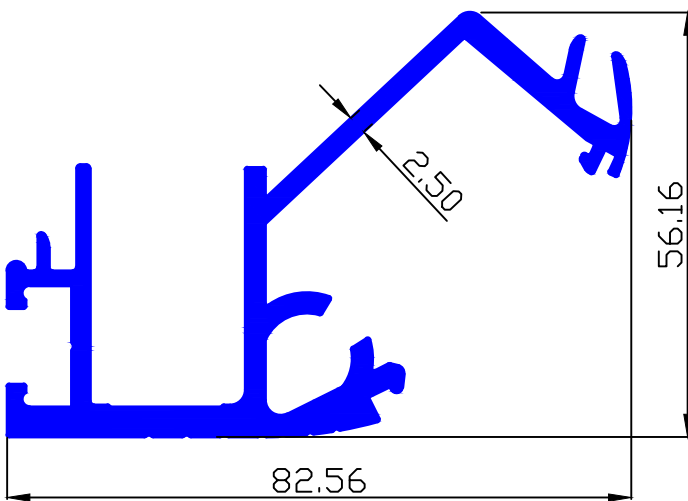

MAAN SEC.-90706

0.823 Kg/Mtr.

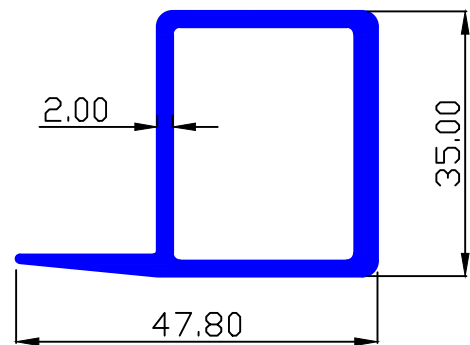

MAAN SEC.-90589

0.621 Kg/Mtr.

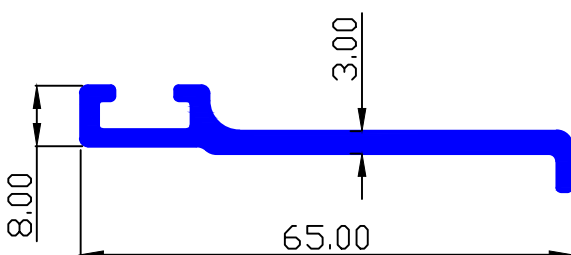

MAAN SEC.-90707

0.709 Kg/Mtr.

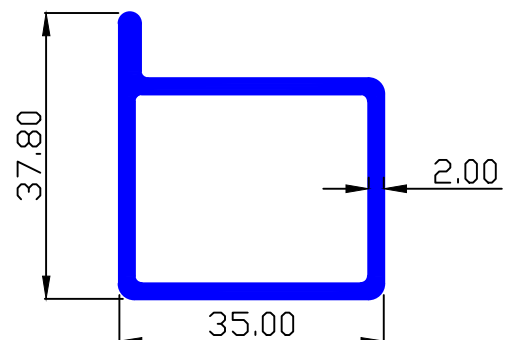



TRRO - 31

**TRANSPORT  
ROAD**

MAAN SEC.-90742

1.423 Kg/Mtr.

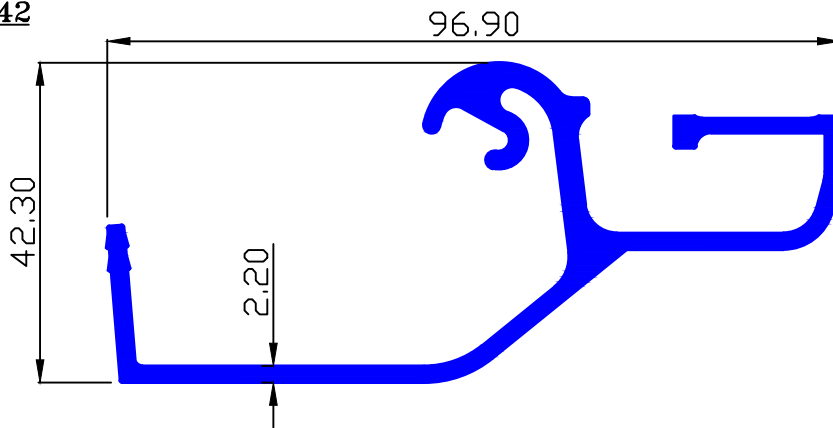

MAAN SEC.-90743

1.334 Kg/Mtr.

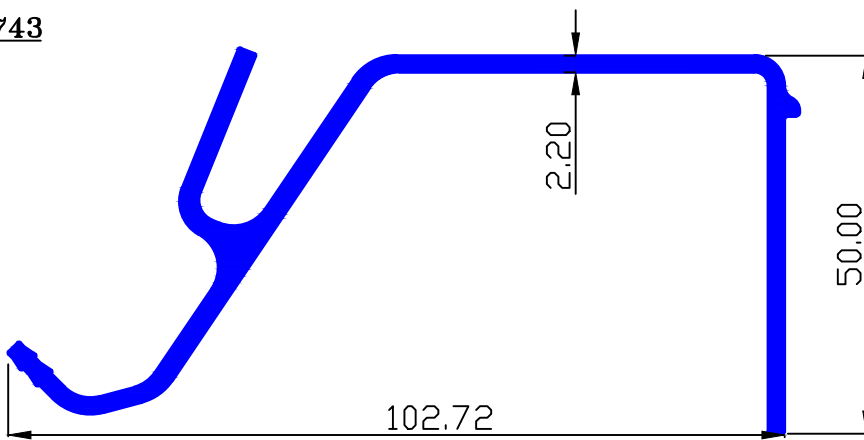

MAAN SEC.-90740

1.531 Kg/Mtr.

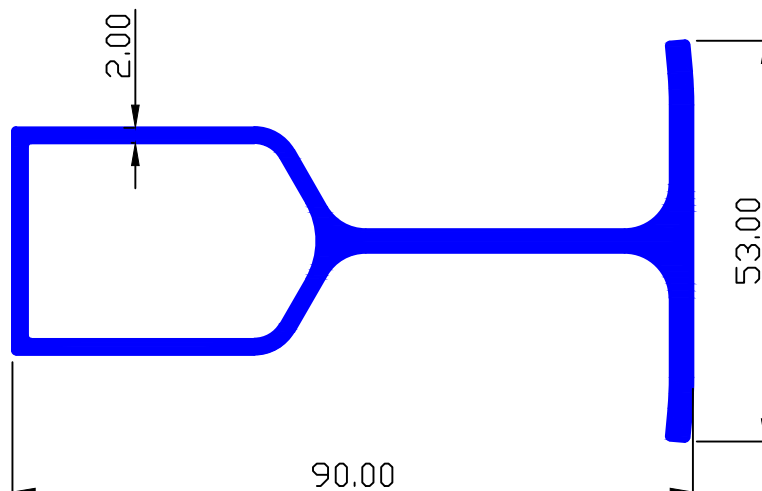



**TRANSPORT  
ROAD**

MAAN SEC.-91002

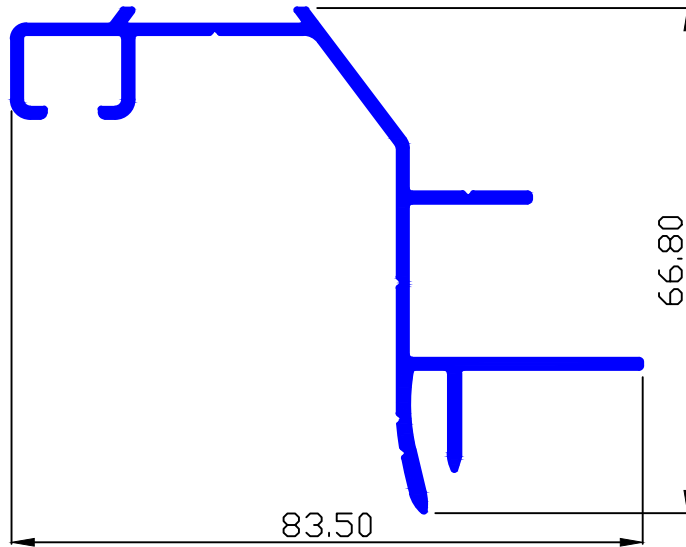

0.815 Kg/Mtr.

MAAN SEC.-90743

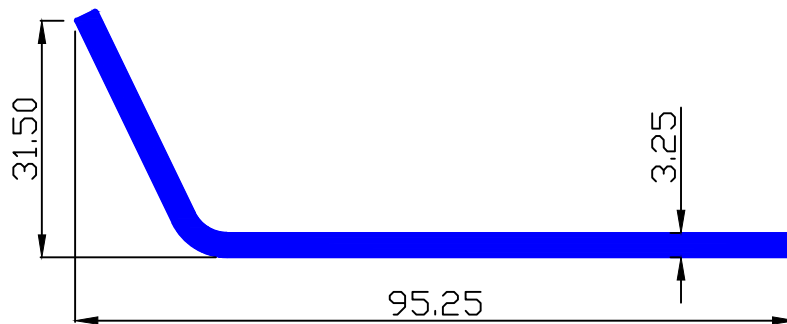

1.334 Kg/Mtr.

MAAN SEC.-90740

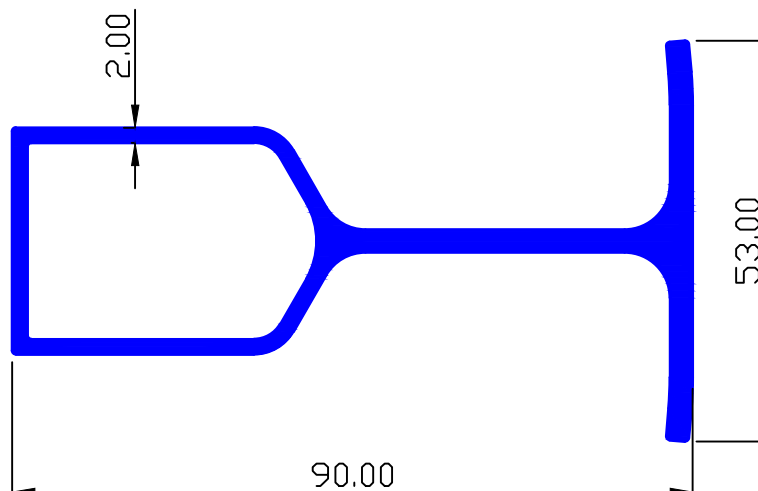

1.531 Kg/Mtr.



TRRO - 33

**TRANSPORT ROAD**

MAAN SEC.-91002

0.689 Kg/Mtr.

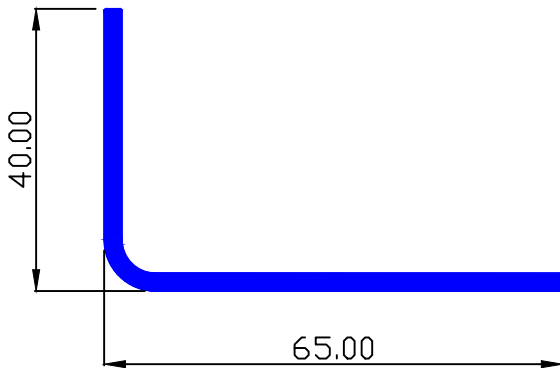

MAAN SEC.-91221

0.753 Kg/Mtr.

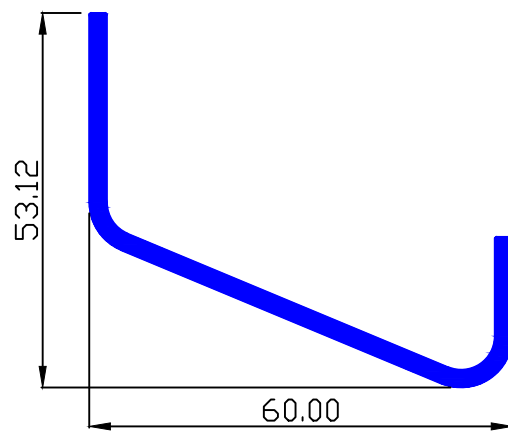

MAAN SEC.-91608

0.112 Kg/Mtr.

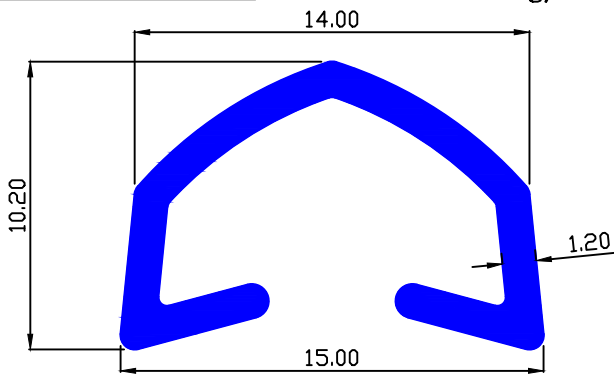

MAAN SEC.-91609

0.517 Kg/Mtr.

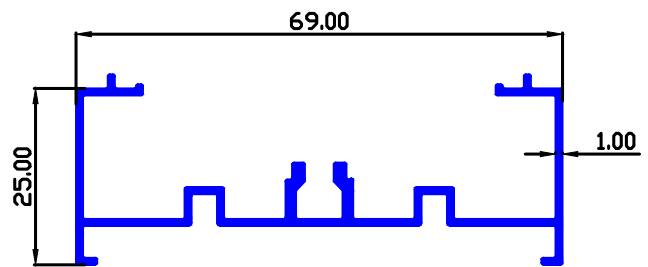

MAAN SEC.-91673

0.314 Kg/Mtr.

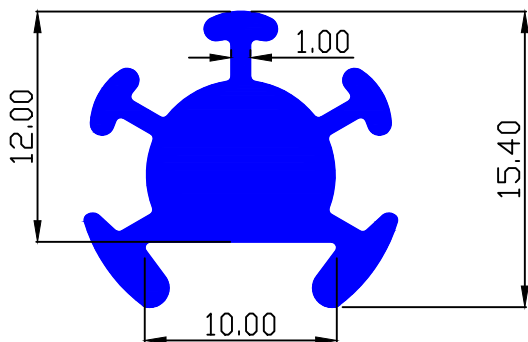

MAAN SEC.-91720

0.142 Kg/Mtr.

