

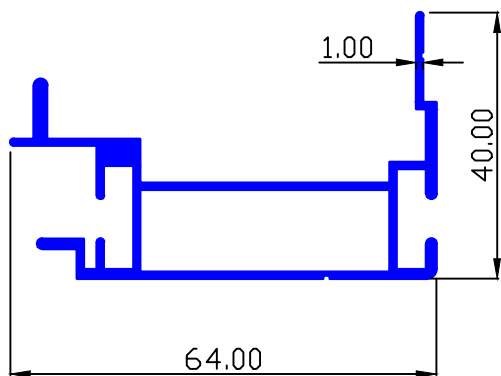

DISPLAY SECTION

MAAN SEC.-7783

0.735 Kg/Mtr.



MAAN SEC.-90586

1.362 Kg/Mtr.

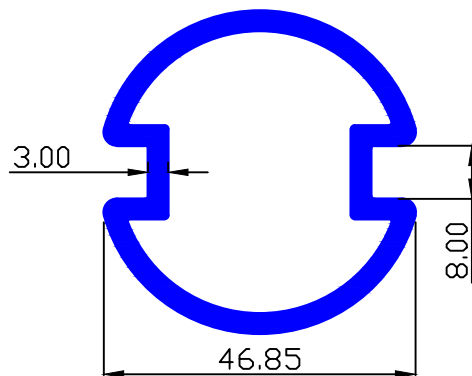

MAAN SEC.-7689

0.267 Kg/Mtr.

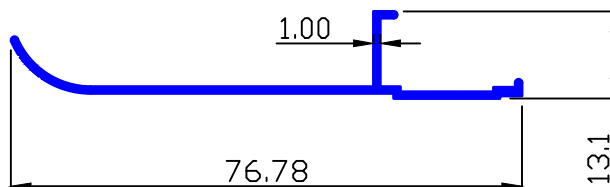

MAAN SEC.-7690

0.865 Kg/Mtr.

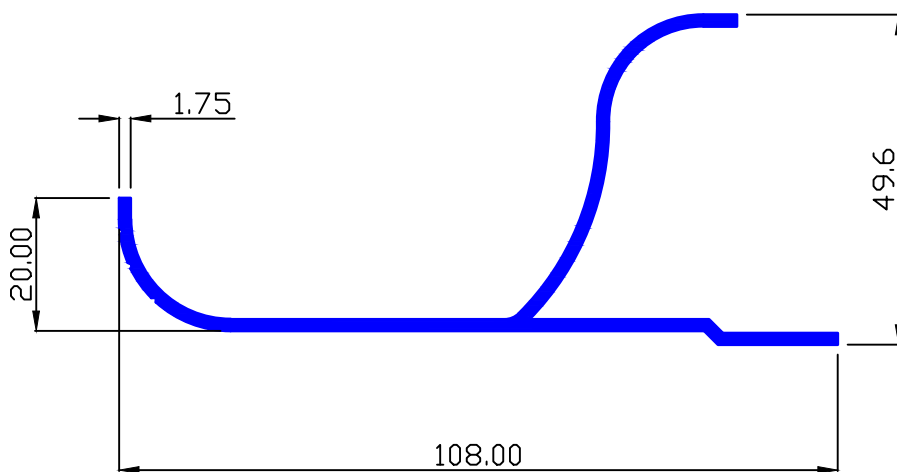



DISPLAY SECTION

MAAN SEC.-7618

0.537 Kg/Mtr.

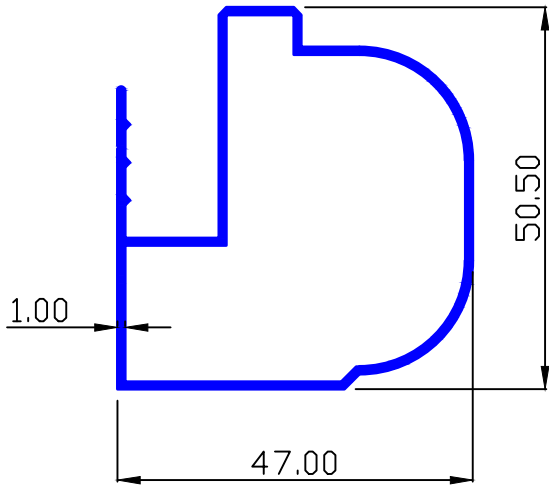

MAAN SEC.-90329

0.297 Kg/Mtr.

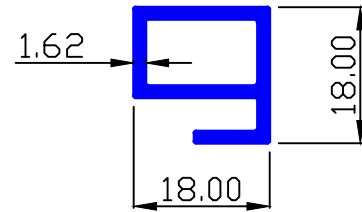

MAAN SEC.-90286

0.501 Kg/Mtr.

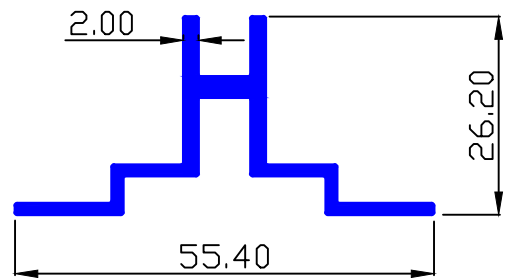

MAAN SEC.-7931

0.233 Kg/Mtr.

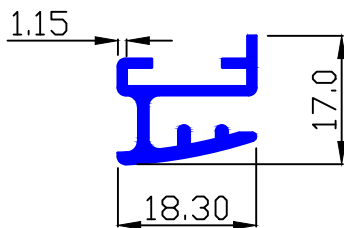

MAAN SEC.-7930

0.269 Kg/Mtr.

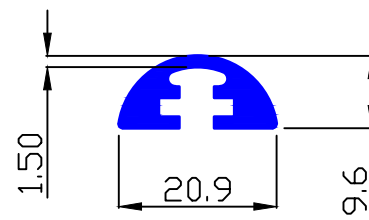

MAAN SEC.-7929

0.530 Kg/Mtr.

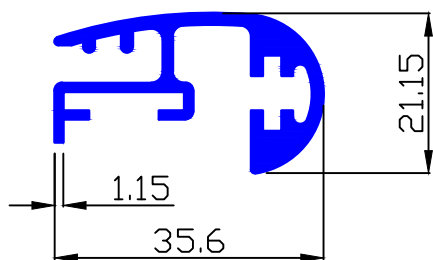

MAAN SEC.-90166

0.076 Kg/Mtr.

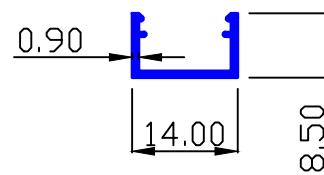

MAAN SEC.-7877

1.022 Kg/Mtr.

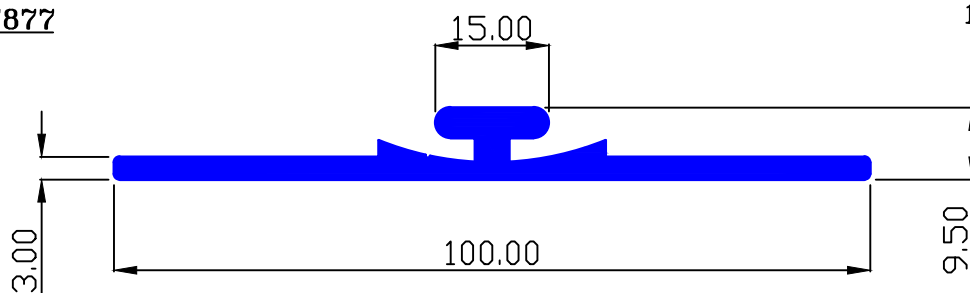



DISPLAY SECTION

MAAN SEC.-8677

0.529 Kg/Mtr.

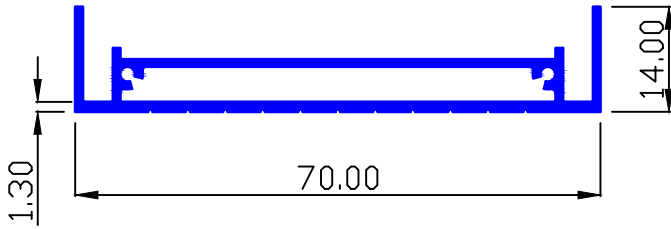

MAAN SEC.-90258

1.087 Kg/Mtr.

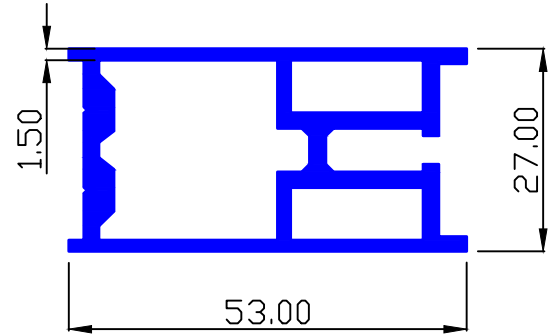

MAAN SEC.-8767

0.370 Kg/Mtr.

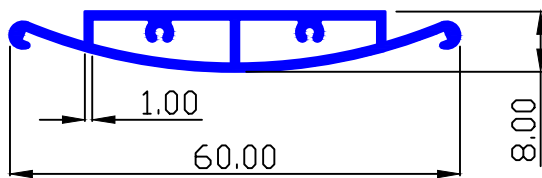

MAAN SEC.-8769

0.836 Kg/Mtr.

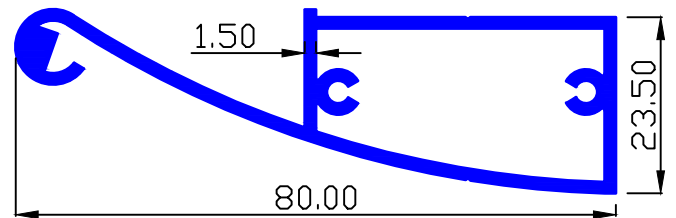

MAAN SEC.-8677

0.684 Kg/Mtr.

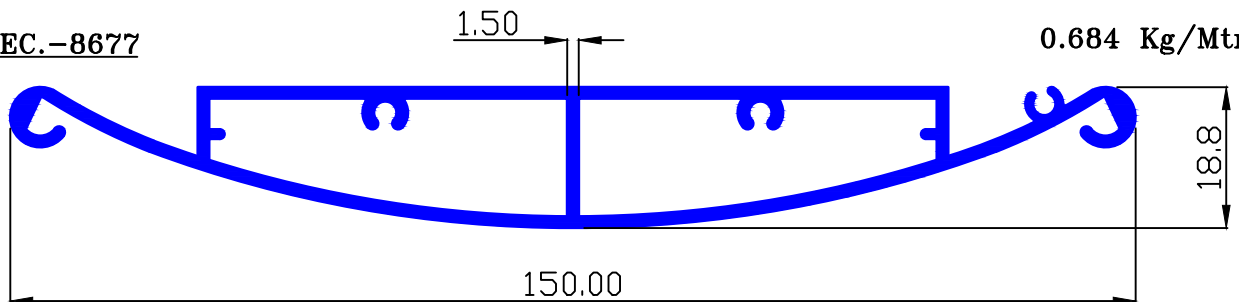

MAAN SEC.-89879

0.340 Kg/Mtr.

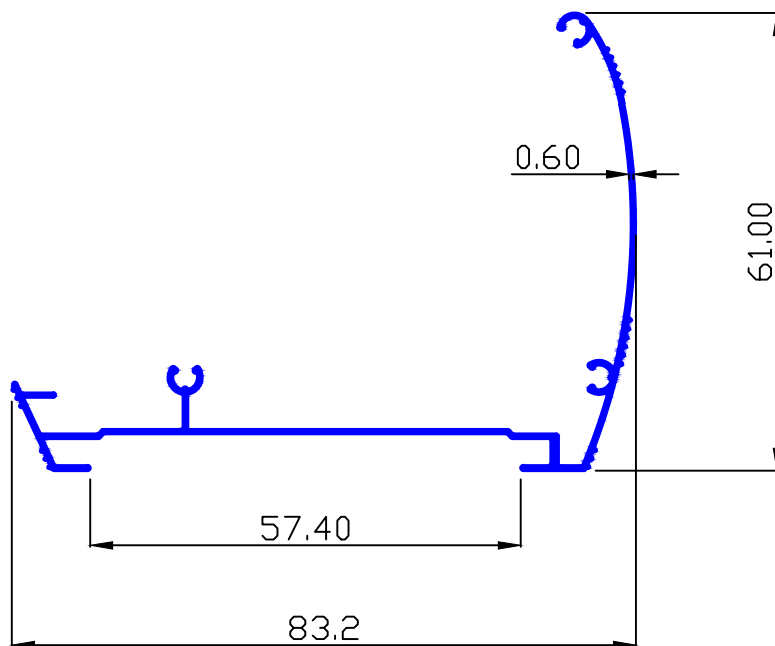



DISPLAY SECTION

MAAN SEC.-8770

0.273 Kg/Mtr.

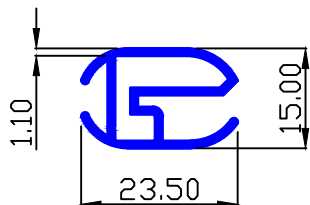

MAAN SEC.-8771

0.743 Kg/Mtr.

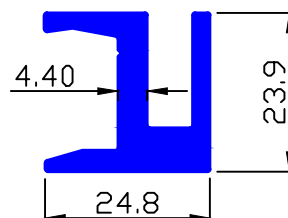

MAAN SEC.-8772

0.321 Kg/Mtr.

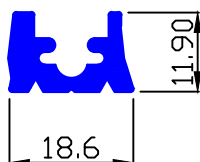

MAAN SEC.-8775

0.362 Kg/Mtr.

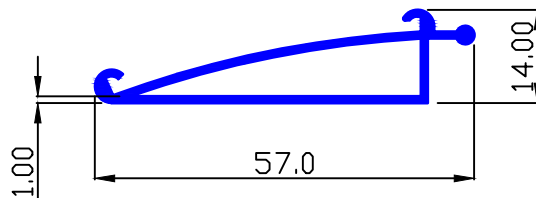

MAAN SEC.-8773

0.811 Kg/Mtr.

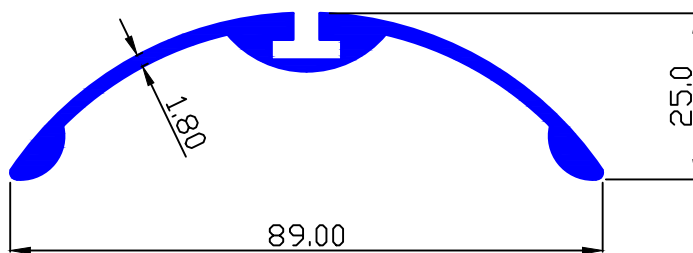

MAAN SEC.-8774

0.716 Kg/Mtr.

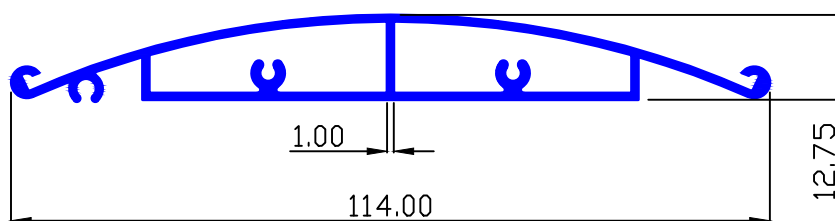

MAAN SEC.-8852

0.442 Kg/Mtr.

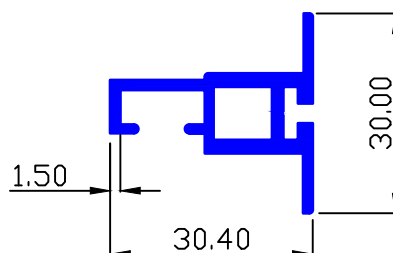



DISPLAY SECTION

MAAN SEC.-8770

0.786 Kg/Mtr.

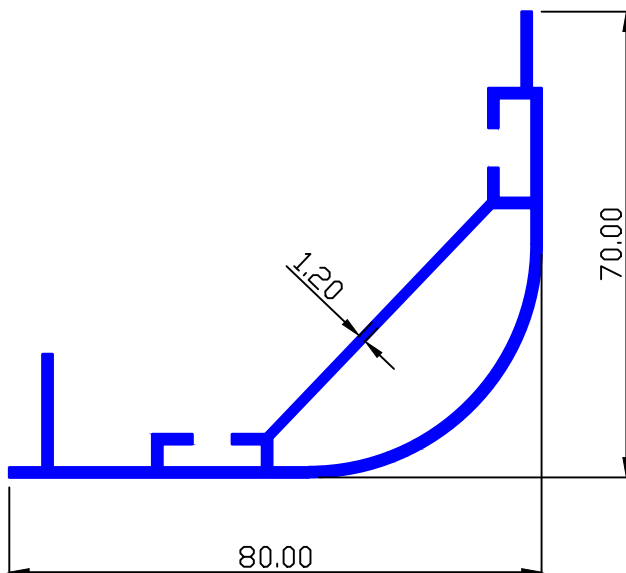

MAAN SEC.-89076

0.675 Kg/Mtr.

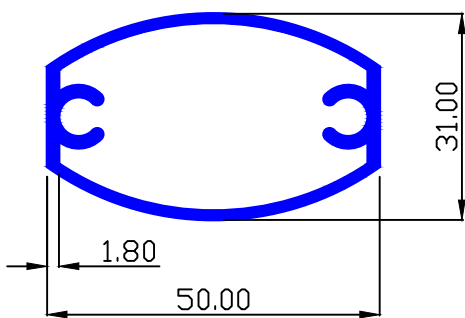

MAAN SEC.-89120

0.178 Kg/Mtr.

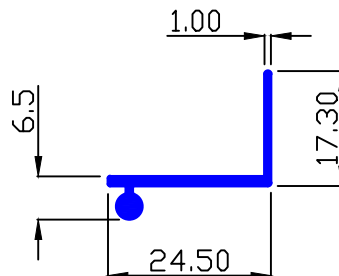

MAAN SEC.-89121

0.659 Kg/Mtr.

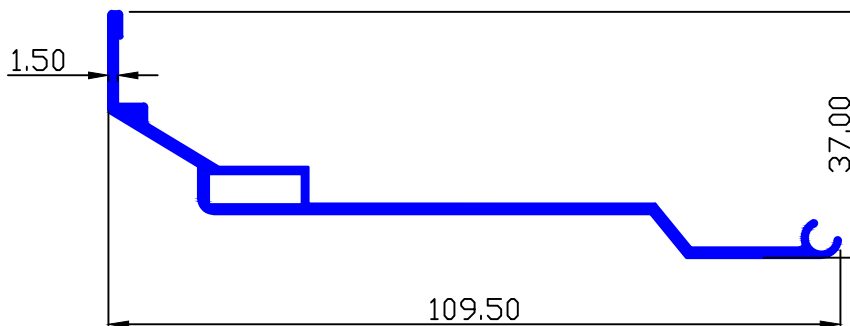



DISPLAY SECTION

MAAN SEC.-89122

1.352 Kg/Mtr.

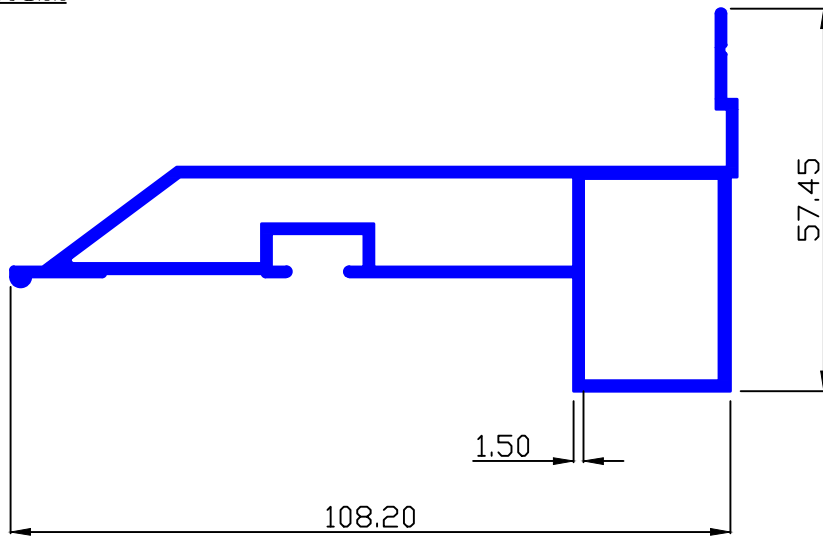

MAAN SEC.-89170

0.569 Kg/Mtr.

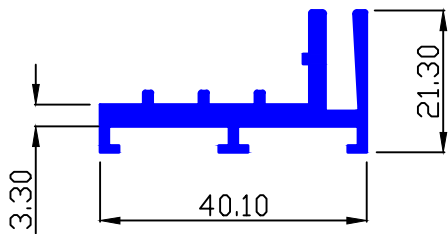

MAAN SEC.-89277

0.183 Kg/Mtr.

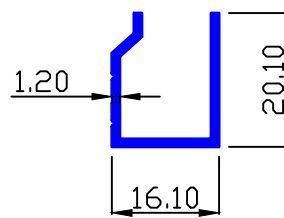

MAAN SEC.-89171

0.826 Kg/Mtr.

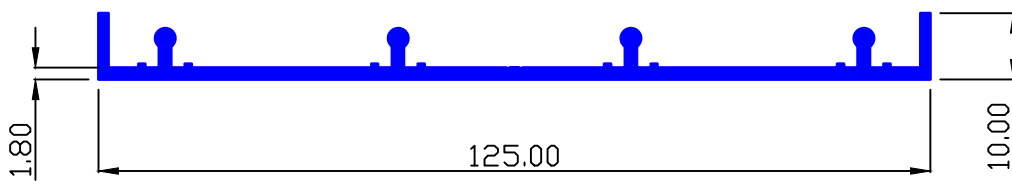

MAAN SEC.-89172

0.830 Kg/Mtr.

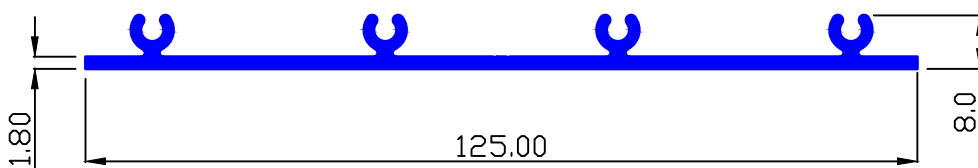



DISPLAY SECTION

MAAN SEC.-89278

0.181 Kg/Mtr.

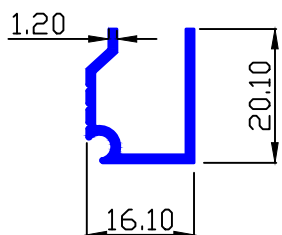

MAAN SEC.-89424

0.767 Kg/Mtr.

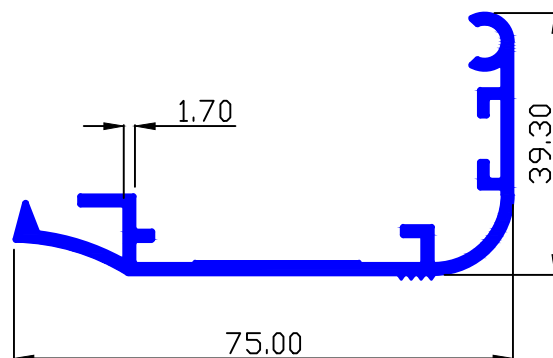

MAAN SEC.-89291

0.880 Kg/Mtr.

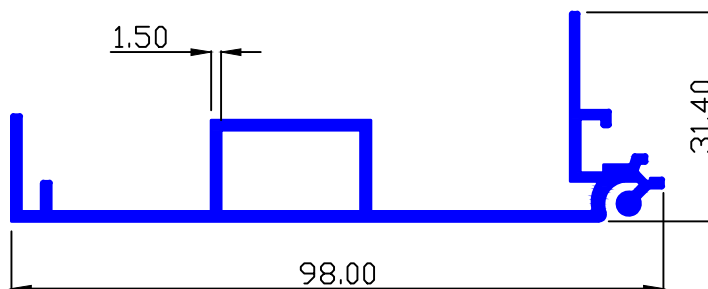

MAAN SEC.-89435

0.170 Kg/Mtr.

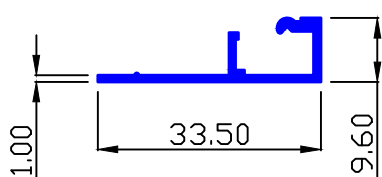

MAAN SEC.-89436

0.105 Kg/Mtr.

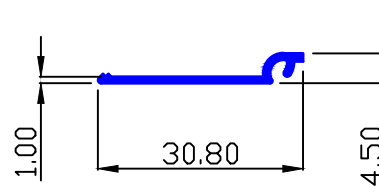

MAAN SEC.-89440

0.310 Kg/Mtr.

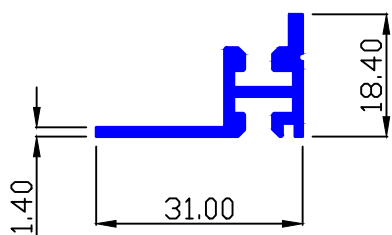

MAAN SEC.-89441

0.415 Kg/Mtr.

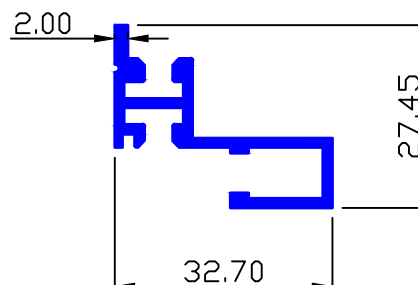



DISPLAY SECTION

MAAN SEC.-89471

0.357 Kg/Mtr.

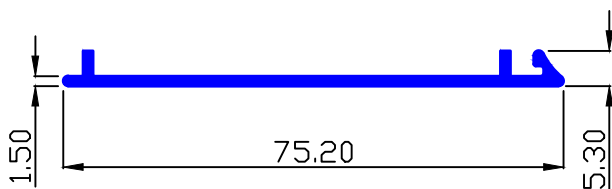

MAAN SEC.-89565

0.200 Kg/Mtr.

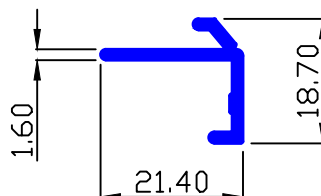

MAAN SEC.-89568

0.282 Kg/Mtr.

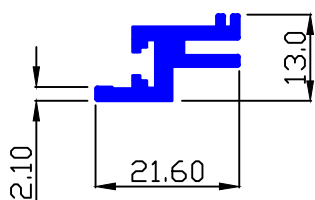

MAAN SEC.-89579

0.275 Kg/Mtr.

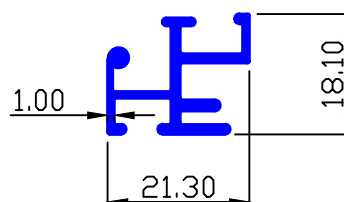

MAAN SEC.-89581

0.861 Kg/Mtr.

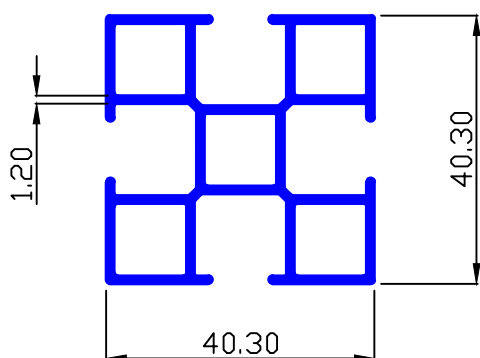

MAAN SEC.-89582

0.581 Kg/Mtr.

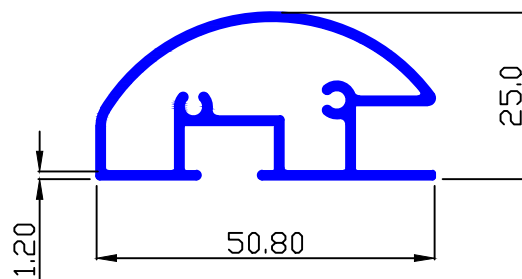

MAAN SEC.-89583

1.353 Kg/Mtr.

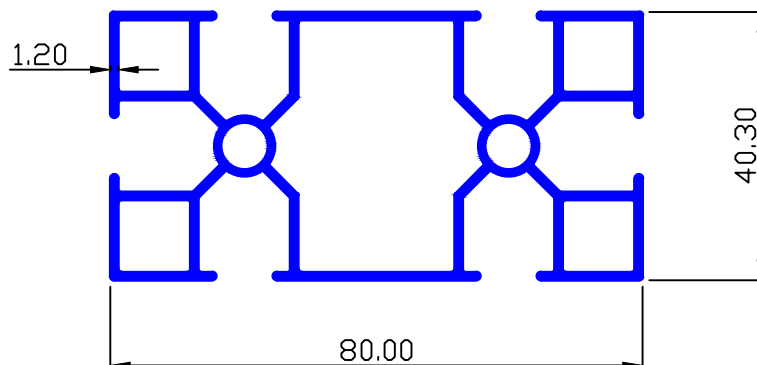



DISPLAY SECTION

MAAN SEC.-89659

0.370 Kg/Mtr.

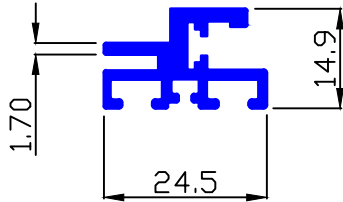

MAAN SEC.-89766

0.320 Kg/Mtr.

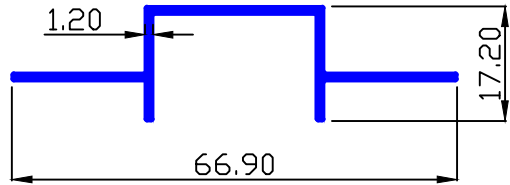

MAAN SEC.-89771

0.373 Kg/Mtr.

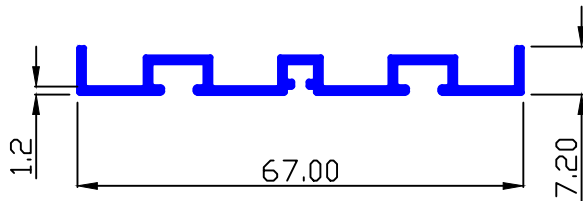

MAAN SEC.-89808

0.183 Kg/Mtr.

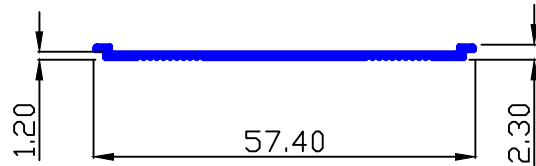

MAAN SEC.-89809

0.513 Kg/Mtr.

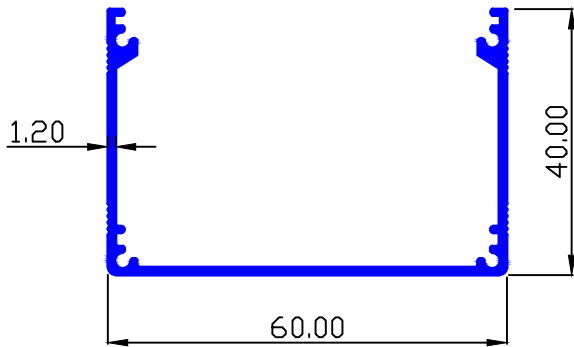

MAAN SEC.-89826

0.825 Kg/Mtr.

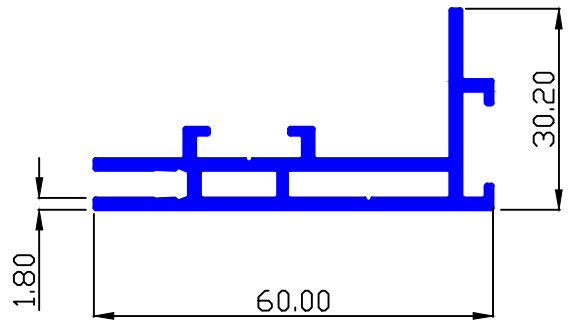

MAAN SEC.-89825

1.214 Kg/Mtr.

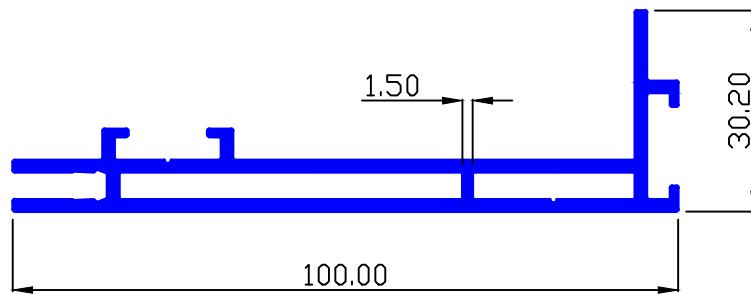



DISPLAY SECTION

MAAN SEC.-90603

2.244 Kg/Mtr.

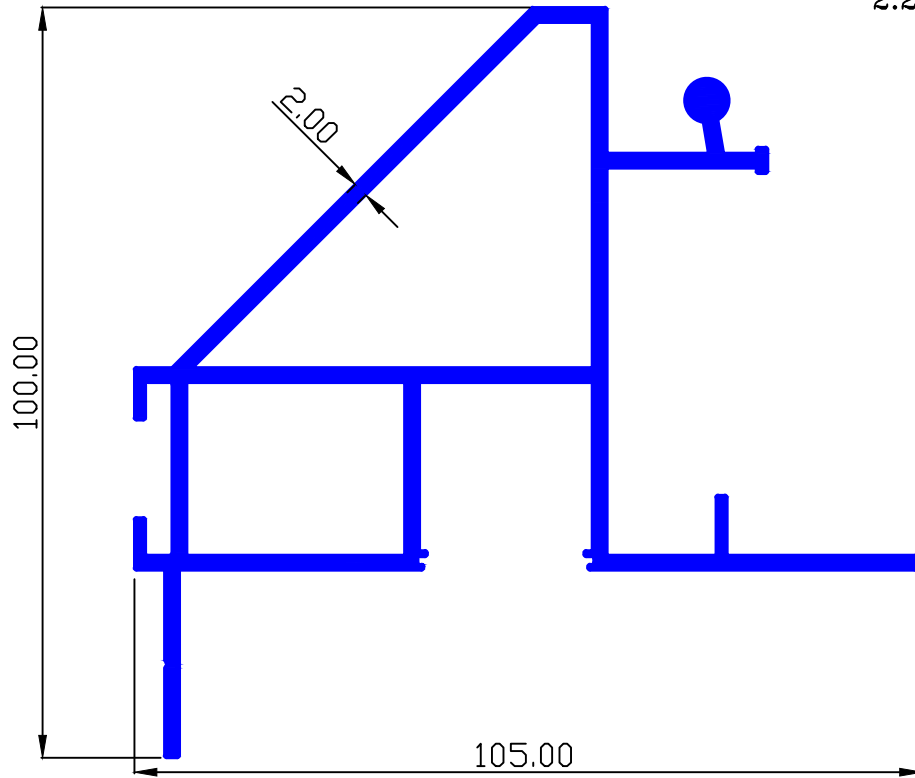

MAAN SEC.-89880

0.301 Kg/Mtr.

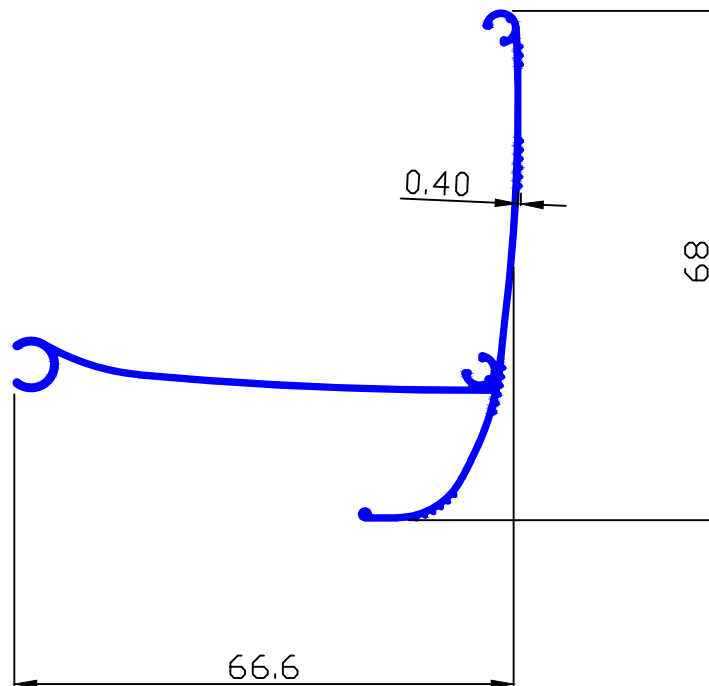



SHINE & DISPLAY

MAAN SEC.-89881

0.098 Kg/Mtr.

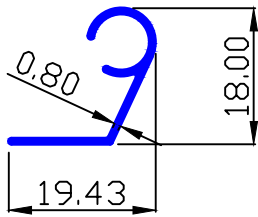

MAAN SEC.-89883

1.033 Kg/Mtr.

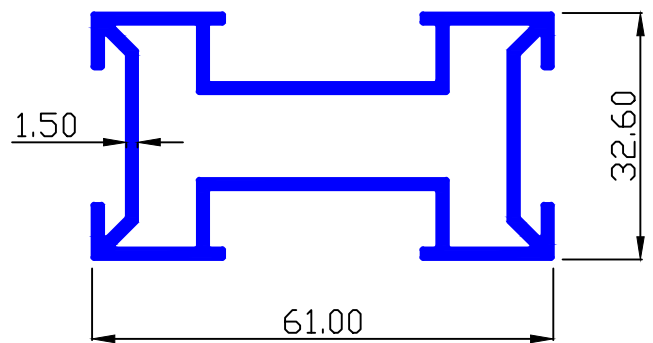

MAAN SEC.-89882

0.095 Kg/Mtr.

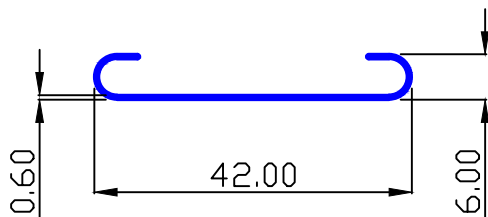

MAAN SEC.-89932

2.192 Kg/Mtr.

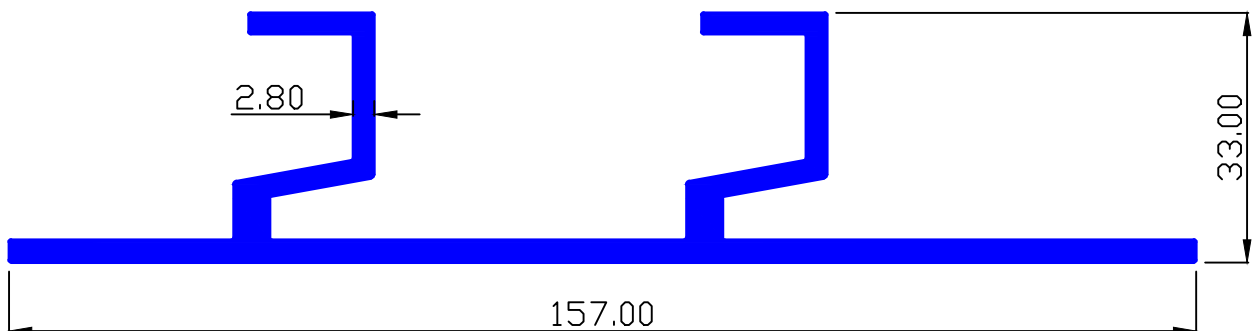

MAAN SEC.-89933

1.333 Kg/Mtr.

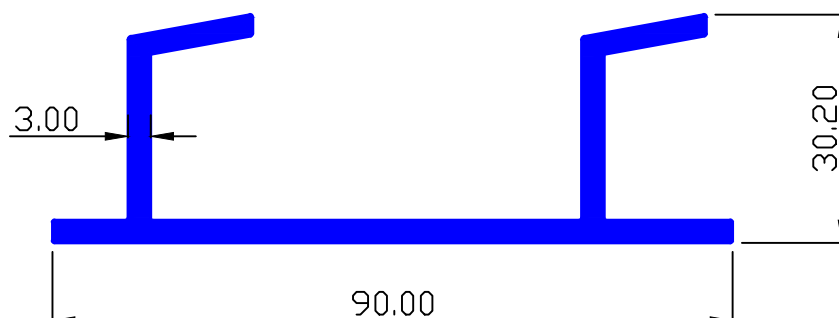



DISPLAY SECTION

MAAN SEC.-89969

2.903 Kg/Mtr.

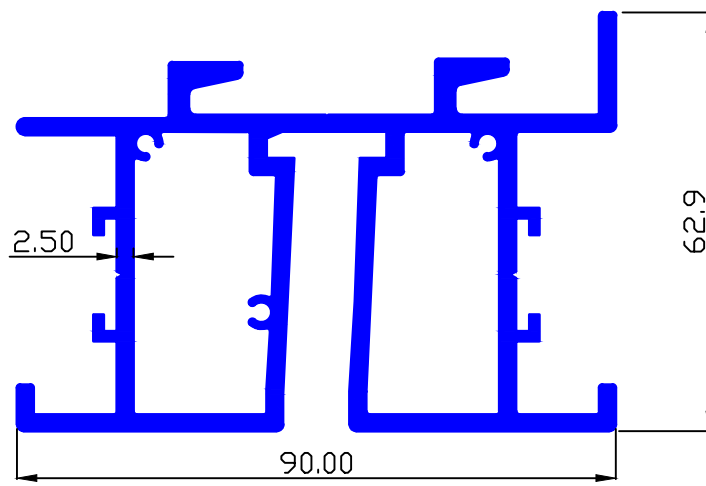

MAAN SEC.-90001

1.252 Kg/Mtr.

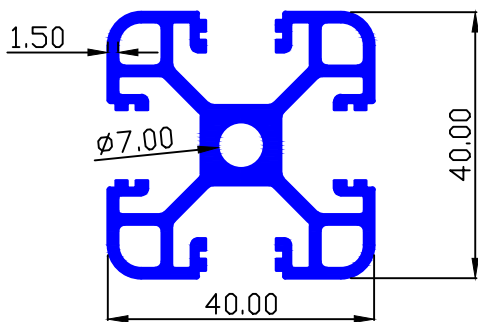

MAAN SEC.-90020

0.738 Kg/Mtr.

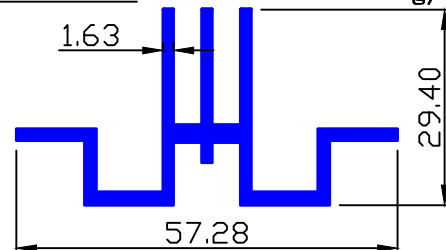

MAAN SEC.-90013

0.813 Kg/Mtr.

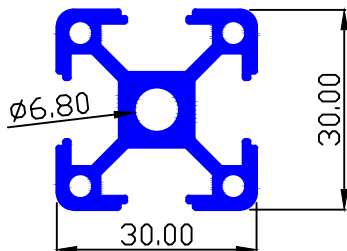

MAAN SEC.-90030

0.210 Kg/Mtr.

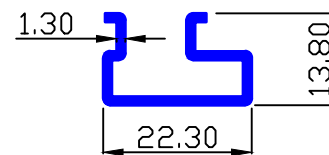

MAAN SEC.-90037

0.139 Kg/Mtr.

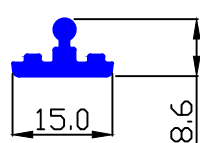

MAAN SEC.-90036

1.441 Kg/Mtr.

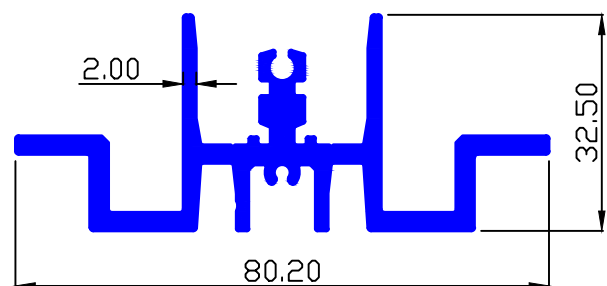



DISPLAY SECTION

MAAN SEC.-90587

0.731 Kg/Mtr.

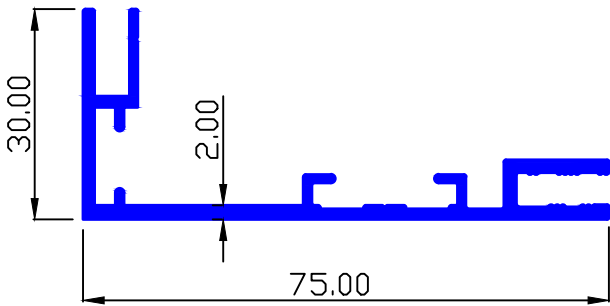

MAAN SEC.-90171

0.079 Kg/Mtr.

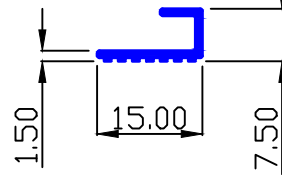

MAAN SEC.-90172

0.139 Kg/Mtr.

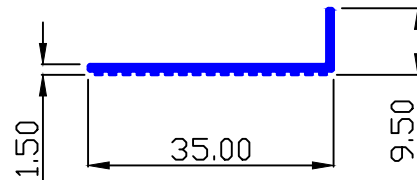

MAAN SEC.-90181

0.747 Kg/Mtr.

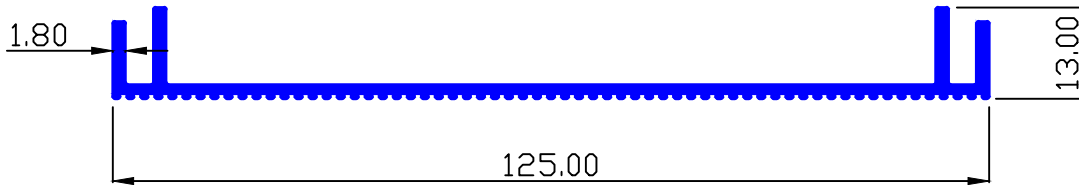

MAAN SEC.-91000

0.226 Kg/Mtr.

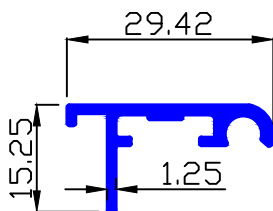

MAAN SEC.-91004

0.650 Kg/Mtr.

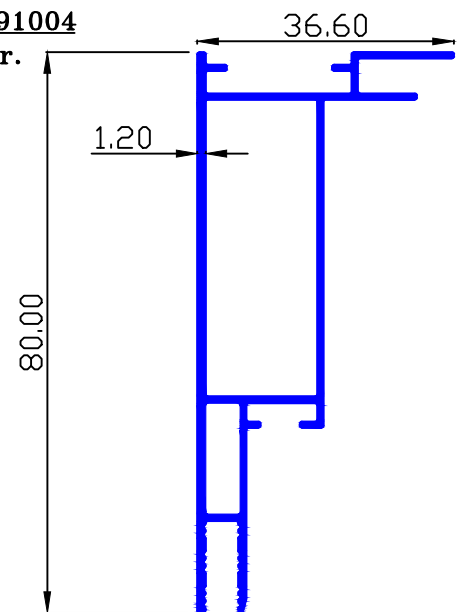

MAAN SEC.-91229

0.402 Kg/Mtr.

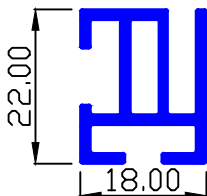



DISPLAY SECTION

MAAN SEC.-90604

2.148 Kg/Mtr.

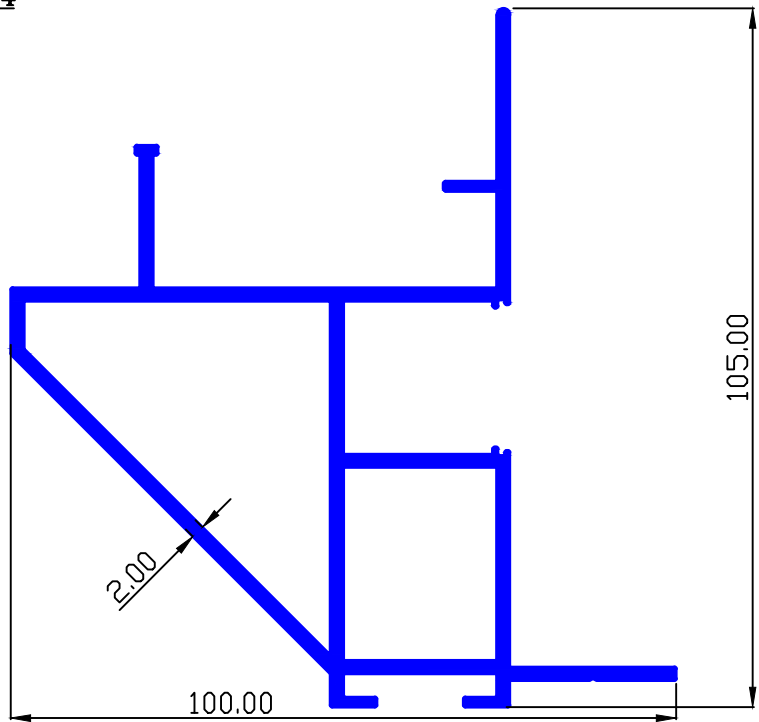

MAAN SEC.-91297

1.227 Kg/Mtr.

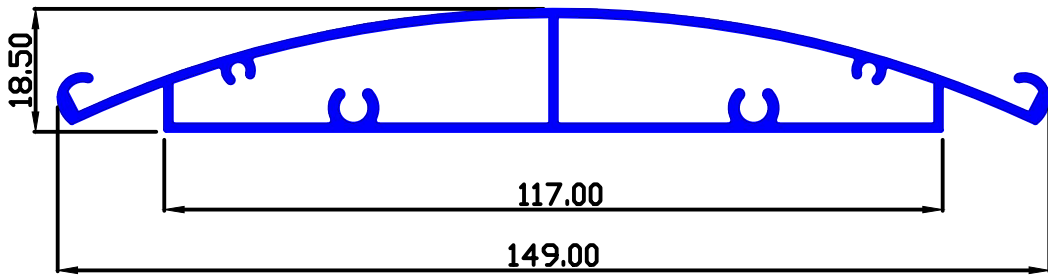



DISPLAY SECTION

MAAN SEC.-91310

5.110 Kg/Mtr.

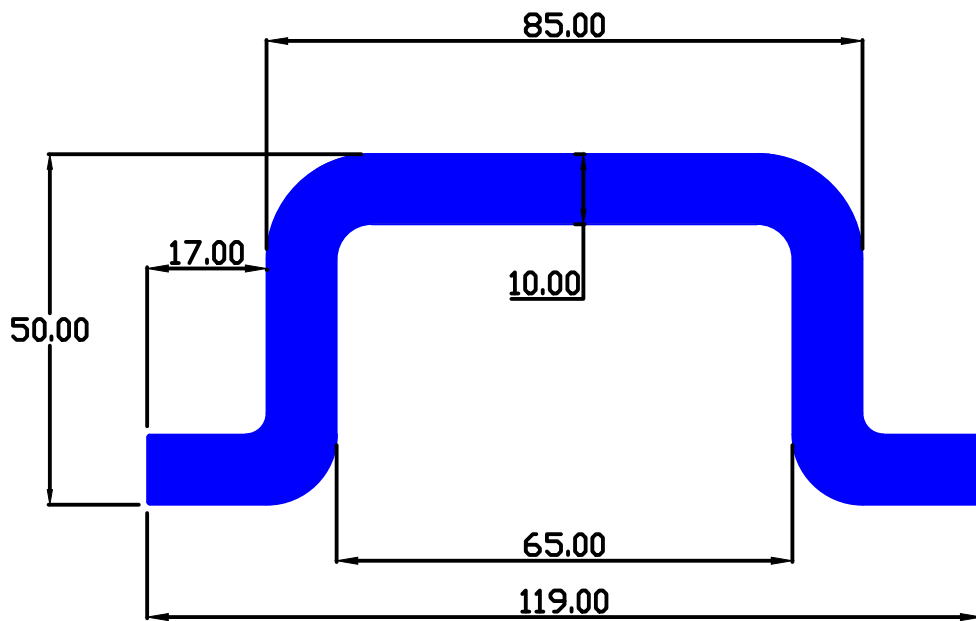

MAAN SEC.-91353

1.175 Kg/Mtr

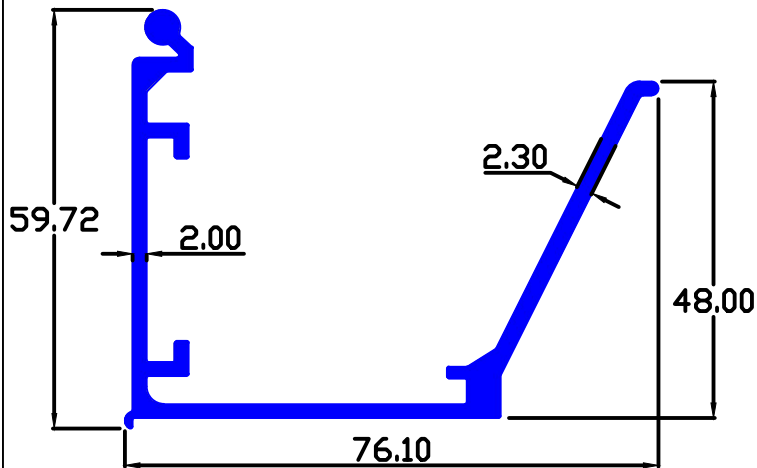

MAAN SEC.-91354

0.415 Kg/Mtr

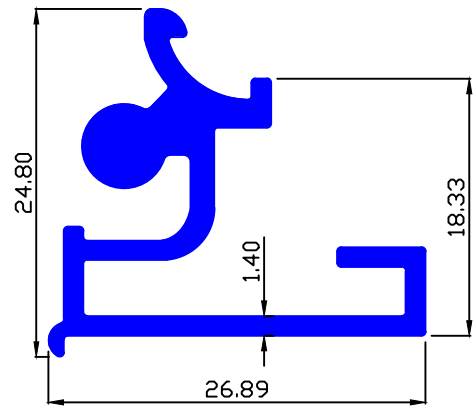



DISPLAY SECTION

MAAN SEC.-91450

0.174 Kg/Mtr

MAAN SEC.-91450

0.201 Kg/Mtr

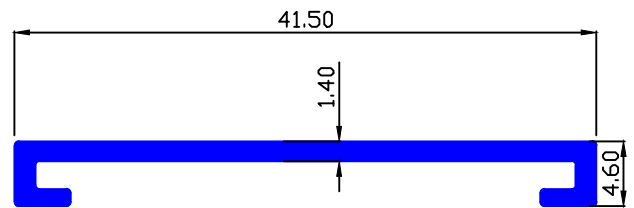
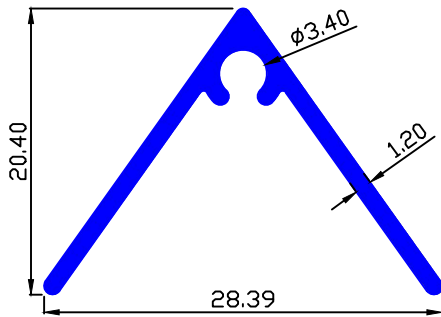

MAAN SEC.-91587

0.508 Kg/Mtr

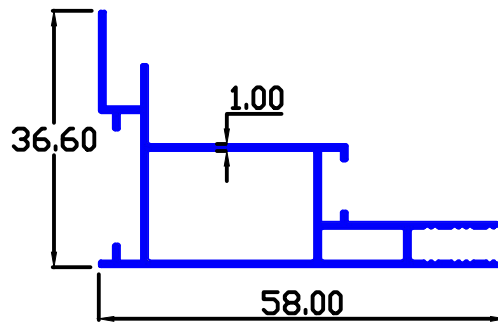

MAAN SEC.-91657

1.398 Kg/Mtr

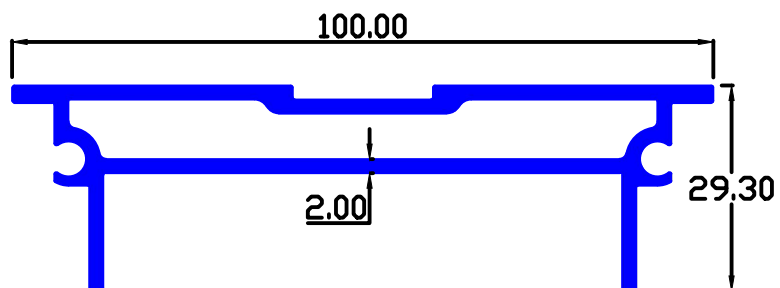



DISPLAY SECTION

MAAN SEC.-91629

0.497 Kg/Mtr

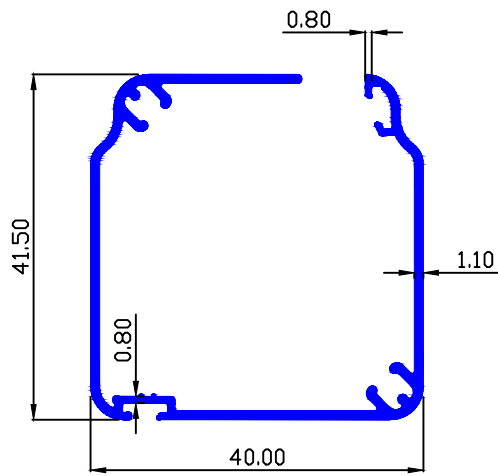

MAAN SEC.-91630

0.802 Kg/Mtr

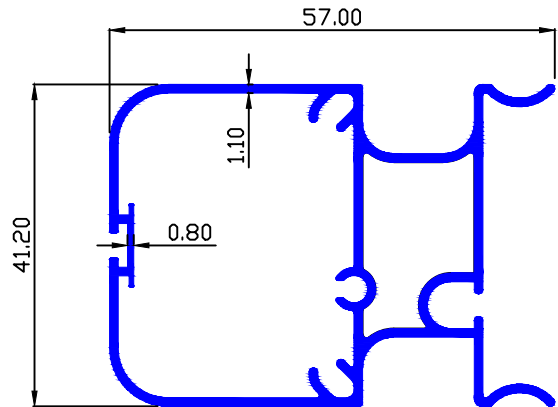

MAAN SEC.-91631

3.296 Kg/Mtr

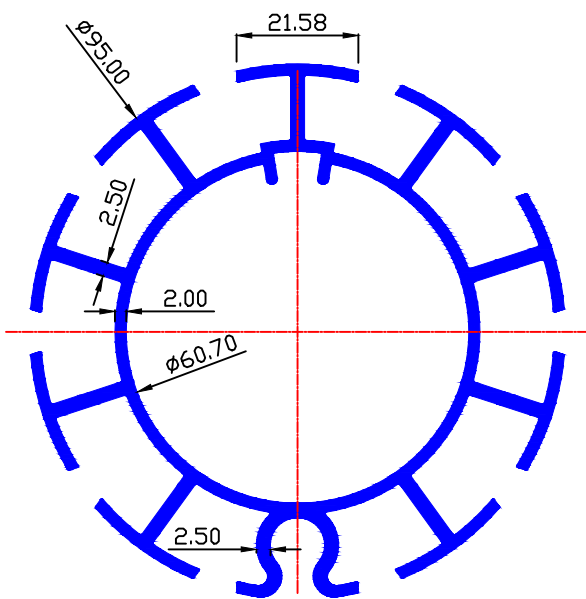

MAAN SEC.-91657

1.398 Kg/Mtr.

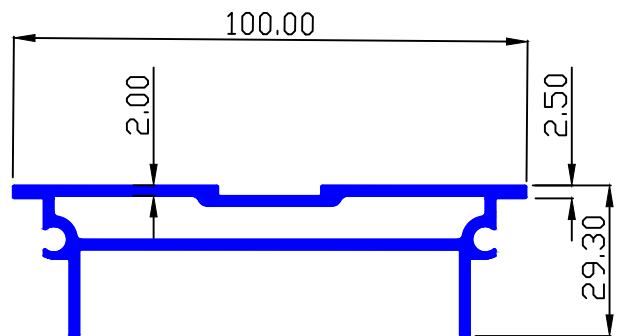

MAAN SEC.-91715

0.056 Kg/Mtr.

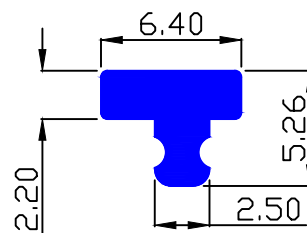



DISPLAY SECTION

MAAN SEC.-91716

0.063 Kg/Mtr.

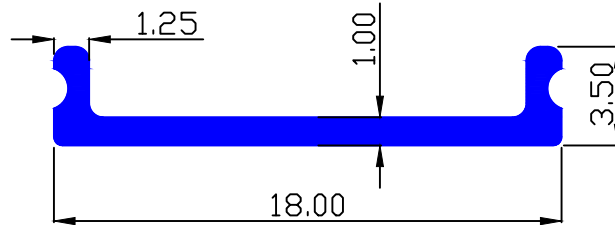

MAAN SEC.-91717

0.825 Kg/Mtr.

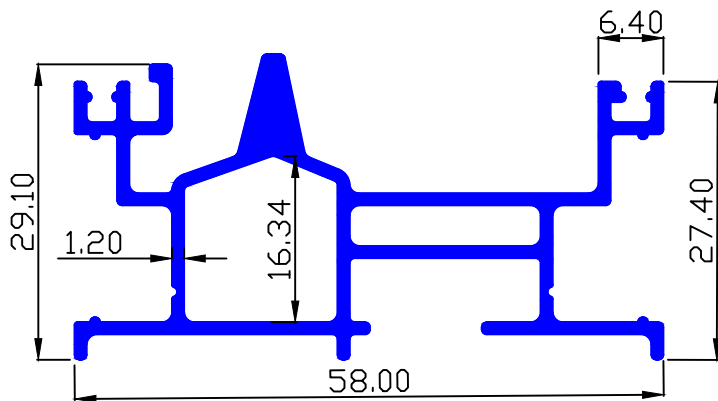

MAAN SEC.-91773

0.924 Kg/Mtr.

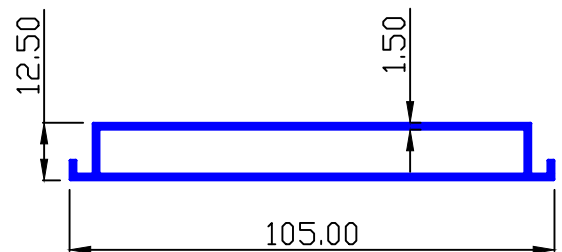

MAAN SEC.-91798

0.500 Kg/Mtr.

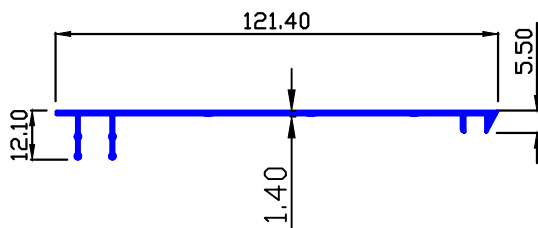

MAAN SEC.-91806

0.413 Kg/Mtr.

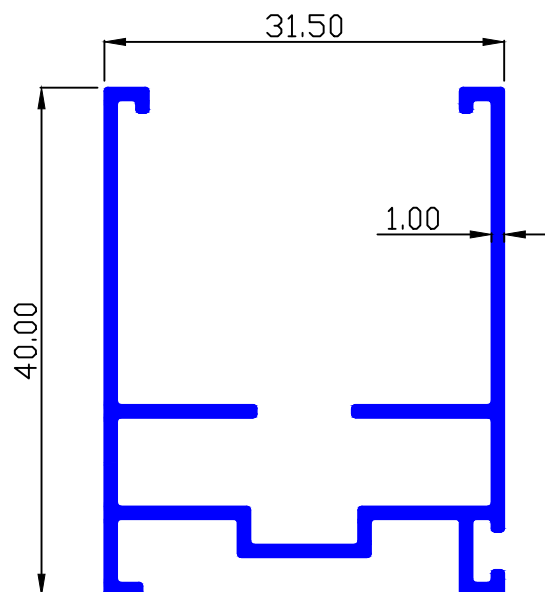



DISPLAY SECTION

MAAN SEC.-91807

0.482 Kg/Mtr.

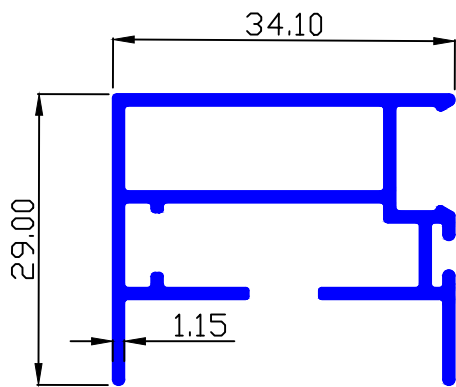

MAAN SEC.-91808

0.577 Kg/Mtr.

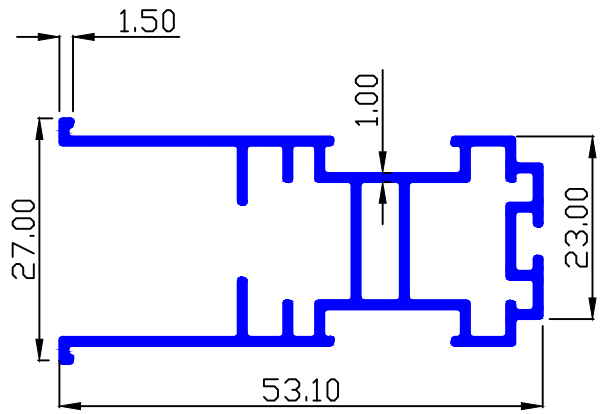

MAAN SEC.-91914

0.330 Kg/Mtr.

