

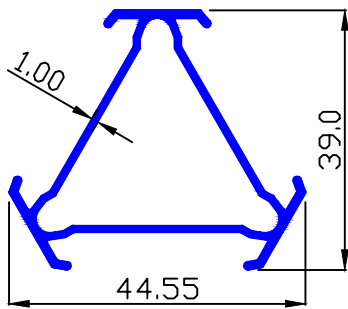

MISCELLANEOUS

MAAN SEC.-89913

0.452 Kg/Mtr.



MAAN SEC.- 90791

0.582 Kg/Mtr.

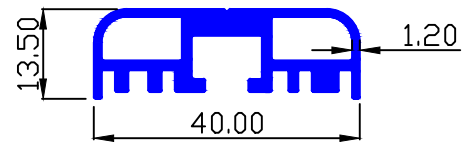

MAAN SEC.-90012

1.388 Kg/Mtr.

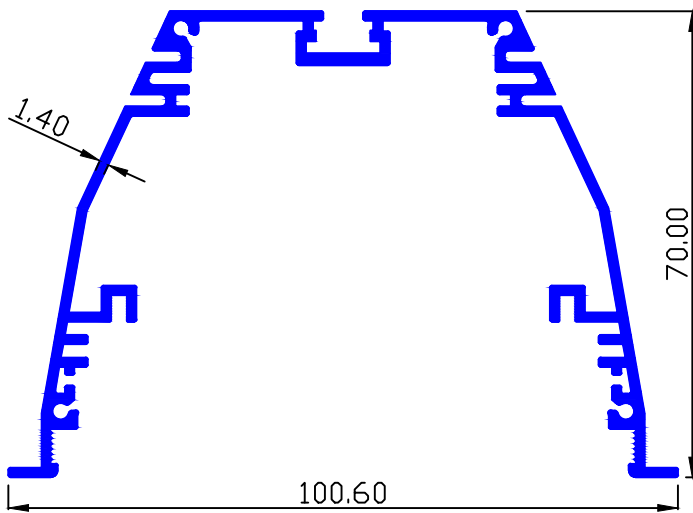

MAAN SEC.-90018

0.212 Kg/Mtr.

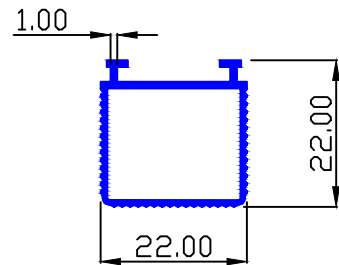

MAAN SEC.-90084

0.592 Kg/Mtr.

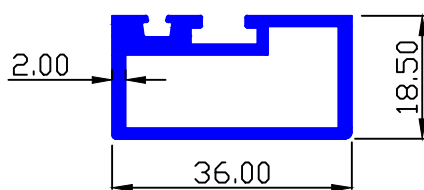

MAAN SEC.-90050

2.425 Kg/Mtr.

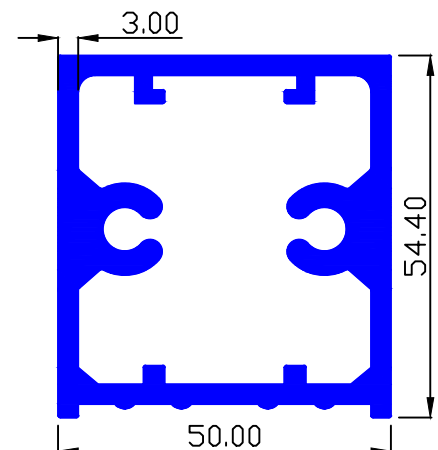



MISCELLANEOUS

MAAN SEC.- 90167

0.561 Kg/Mtr.

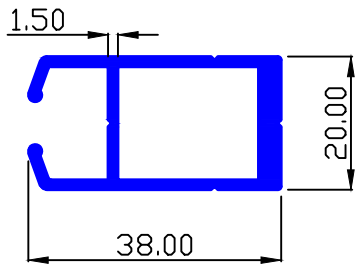

MAAN SEC.- 90245

1.305 Kg/Mtr.

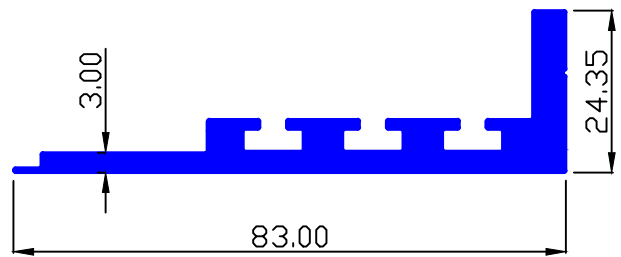

MAAN SEC.-90186

3.098 Kg/Mtr.

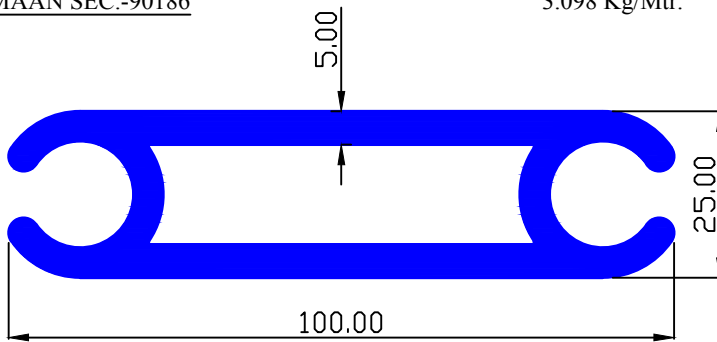

MAAN SEC.-90246

1.009 Kg/Mtr.

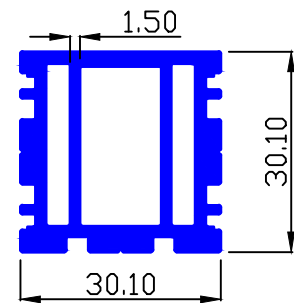

MAAN SEC.-90249

1.625 Kg/Mtr.

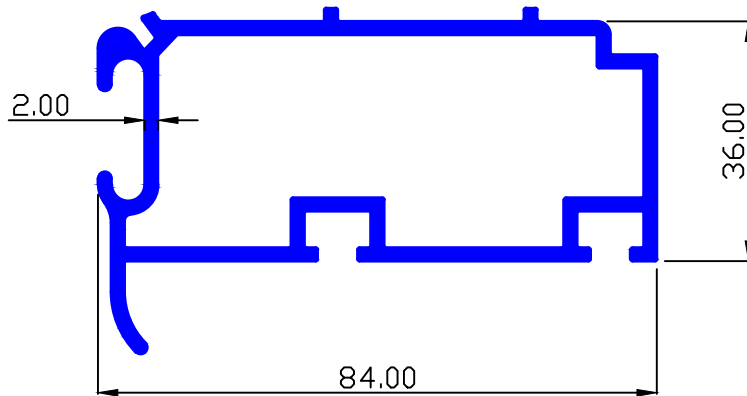



MISCELLANEOUS

MAAN SEC.- 90250

1.825 Kg/Mtr.

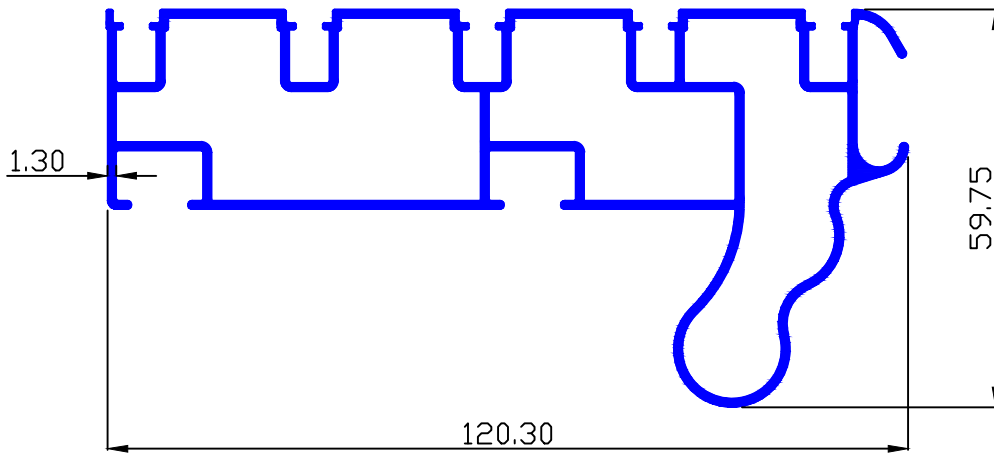

MAAN SEC.-90251

0.622 Kg/Mtr.

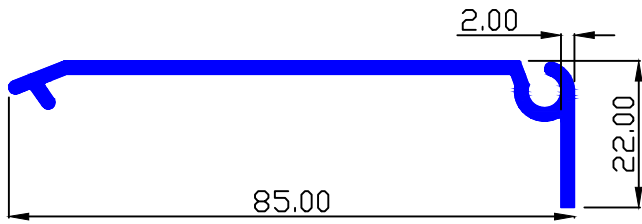

MAAN SEC.-90319

0.302 Kg/Mtr.

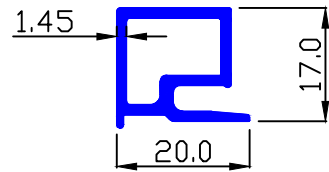

MAAN SEC.-90382

0.776 Kg/Mtr.

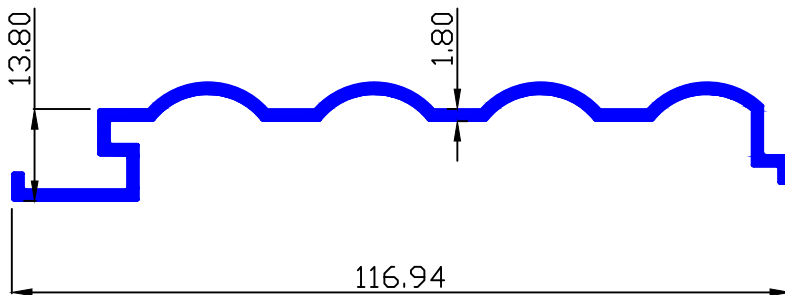

MAAN SEC.-90380

2.077 Kg/Mtr.

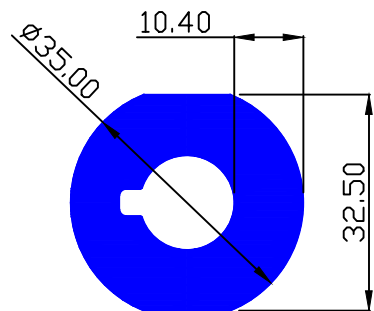



MISCELLANEOUS

MAAN SEC.- 90334

2.035 Kg/Mtr.

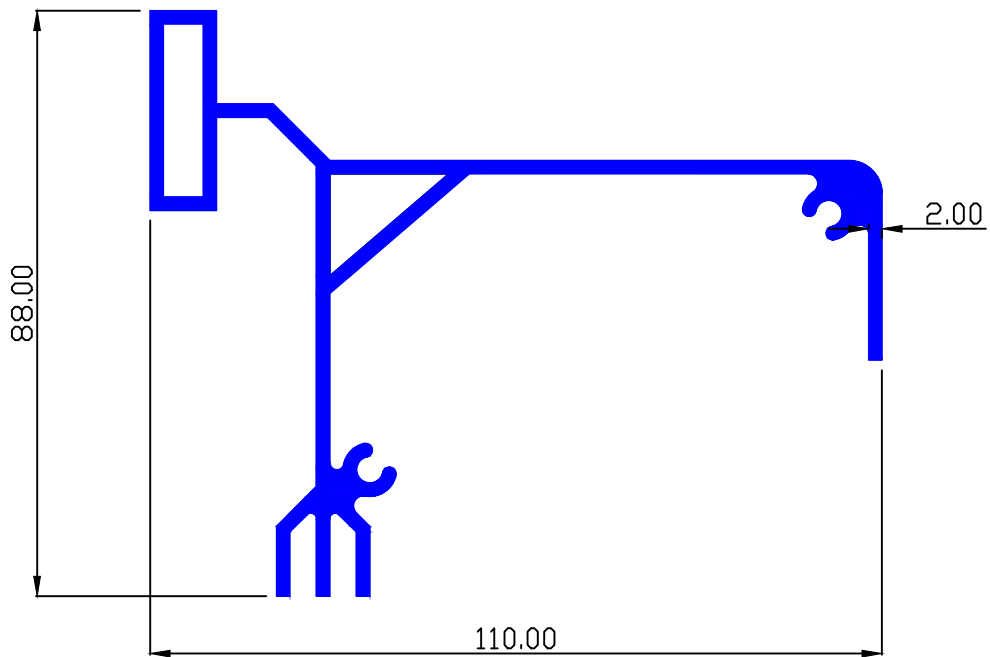

MAAN SEC.- 90364

0.511 Kg/Mtr.

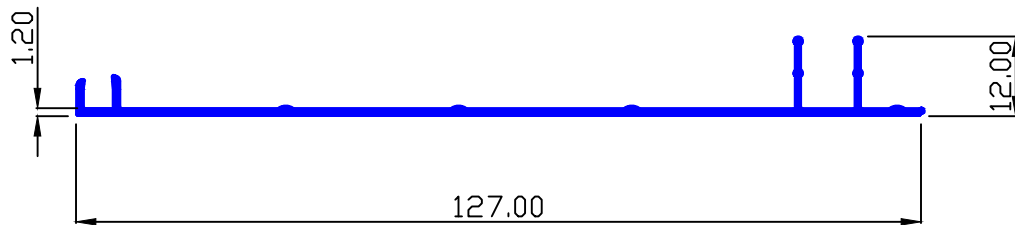



MISCELLANEOUS

MAAN SEC.- 90381

2.244 Kg/Mtr.

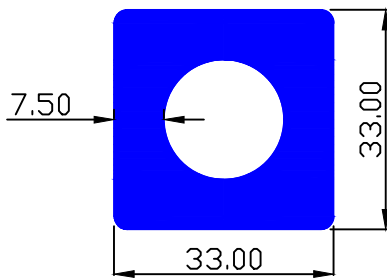

MAAN SEC.-90053

1.522 Kg/Mtr.

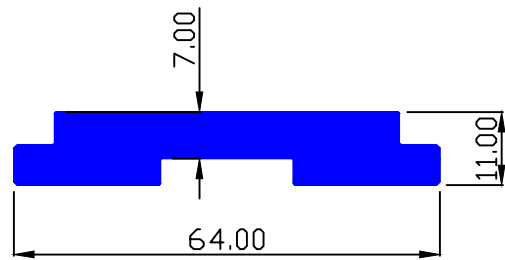

MAAN SEC.- 90399

1.036 Kg/Mtr.

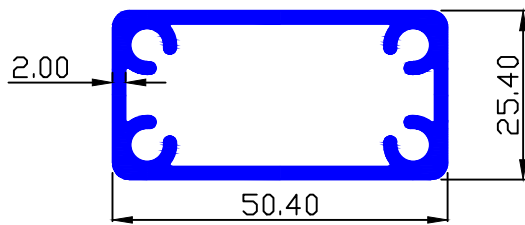

MAAN SEC.- 90402

0.753 Kg/Mtr.

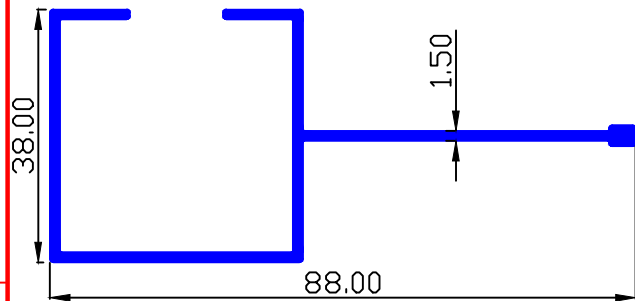

MAAN SEC.- 90540

1.923 Kg/Mtr.

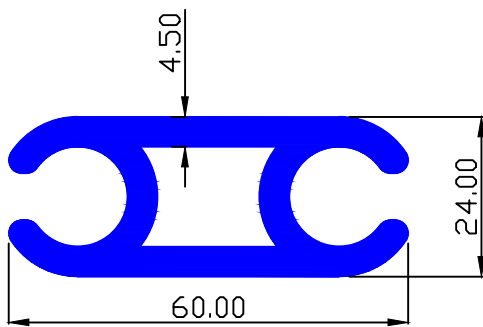

MAAN SEC.-90532

1.527 Kg/Mtr.

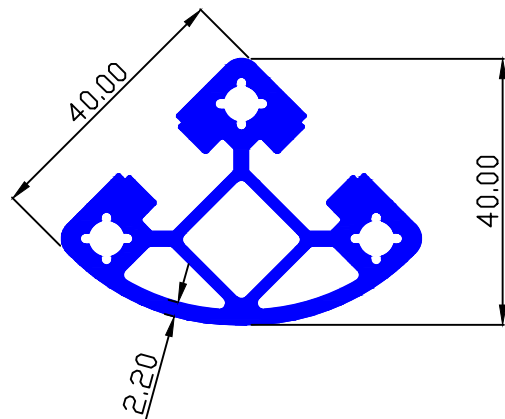



MISCELLANEOUS

MAAN SEC.- 90574

0.470 Kg/Mtr.

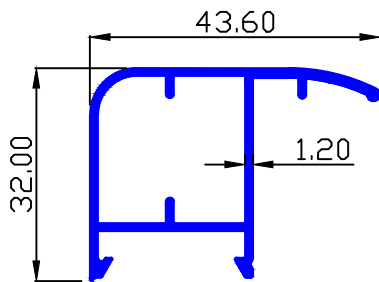

MAAN SEC.- 90591

0.458 Kg/Mtr.

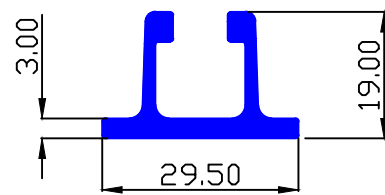

MAAN SEC.- 90592

0.559 Kg/Mtr.

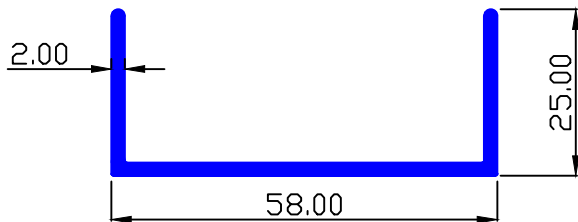

MAAN SEC.- 90642

0.857 Kg/Mtr.

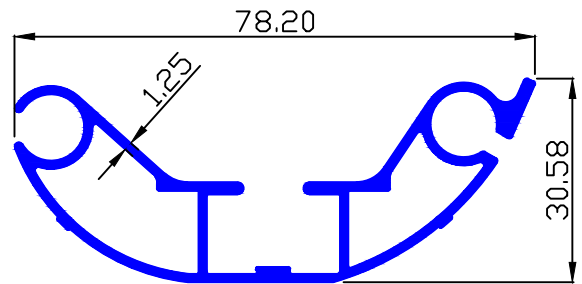

MAAN SEC.- 90602

1.275 Kg/Mtr.

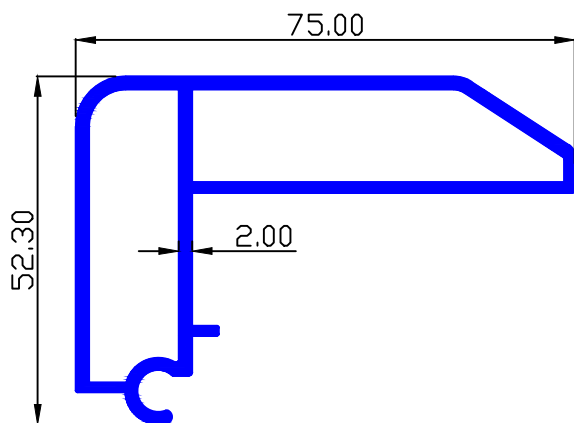

MAAN SEC.- 90750

1.868 Kg/Mtr.

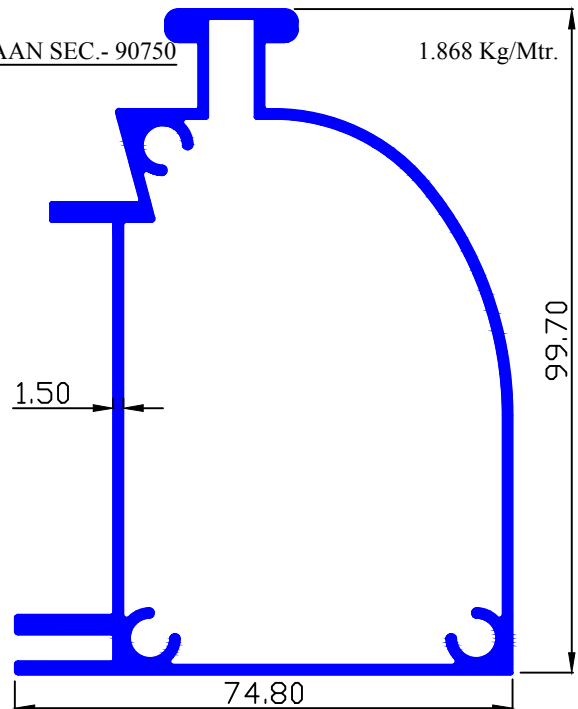



MISCELLANEOUS

MAAN SEC.- 90751

0.948 Kg/Mtr.

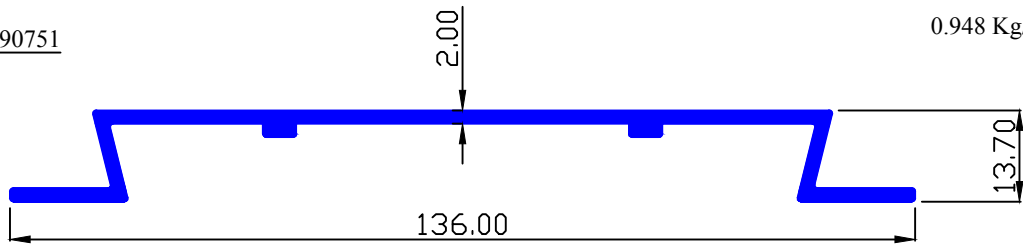

MAAN SEC.- 90763

0.265 Kg/Mtr.

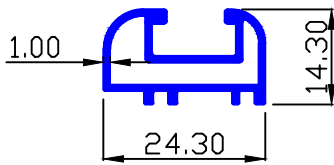

MAAN SEC.- 90767

0.112 Kg/Mtr.

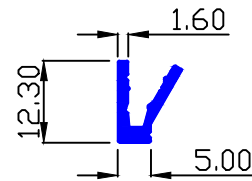

MAAN SEC.- 90768

0.165 Kg/Mtr.

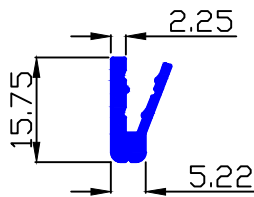

MAAN SEC.- 90772

0.347 Kg/Mtr.

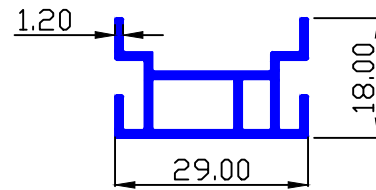

MAAN SEC.- 90773

0.732 Kg/Mtr.

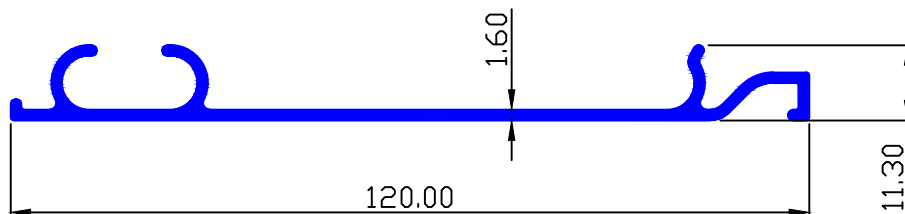



MISCELLANEOUS

MAAN SEC.- 90774

0.088 Kg/Mtr.

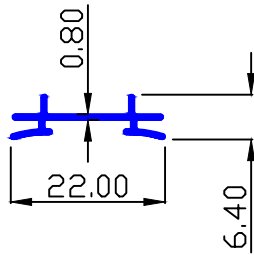

MAAN SEC.- 90780

0.101 Kg/Mtr.

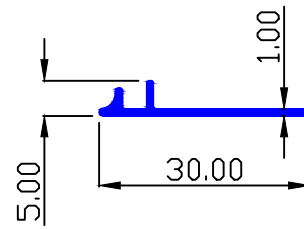

MAAN SEC.- 90781

0.179 Kg/Mtr.

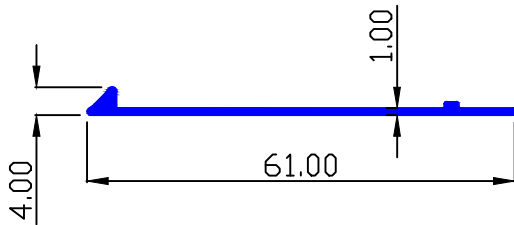

MAAN SEC.- 91015

0.356 Kg/Mtr.

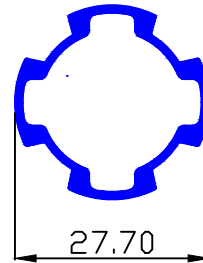

MAAN SEC.- 91069

1.285 Kg/Mtr.

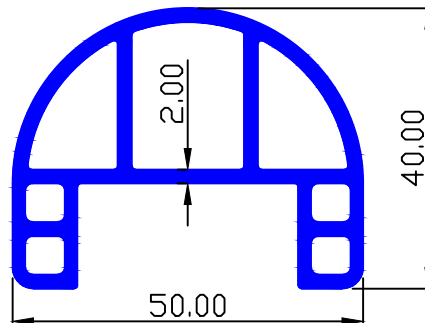



MISCELLANEOUS

MAAN SEC.- 91025

2.225 Kg/Mtr.

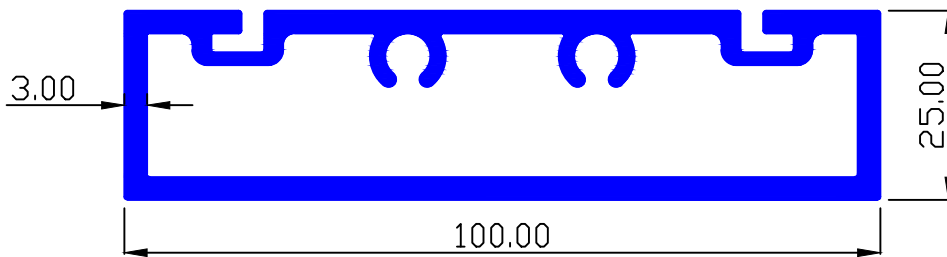

MAAN SEC.- 91026

3.198 Kg/Mtr.

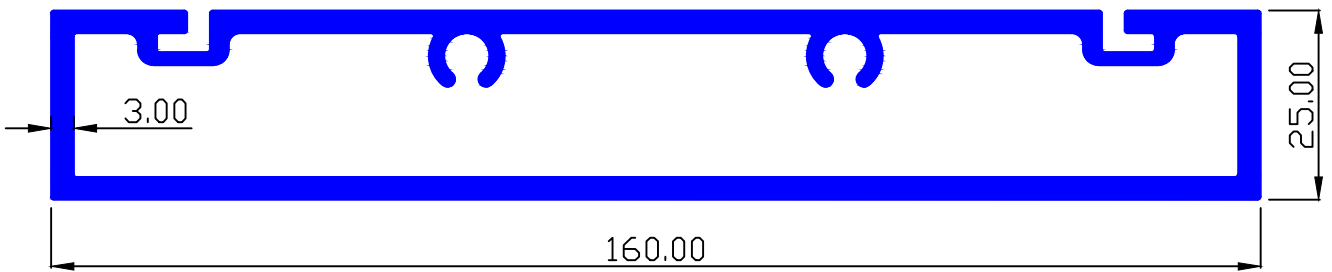

MAAN SEC.- 91027

1.943 Kg/Mtr.

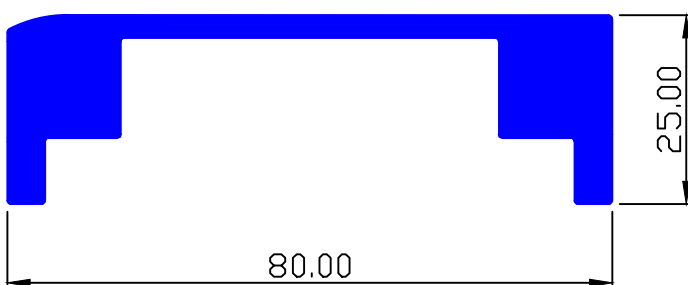

MAAN SEC.- 91164

1.400 Kg/Mtr.

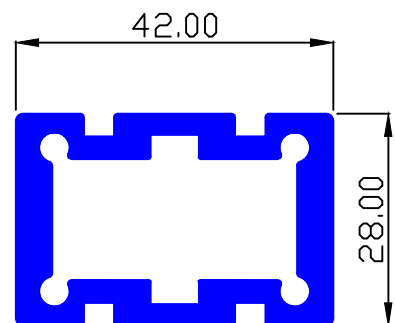



MISCELLANEOUS

MAAN SEC.- 91091

1.091 Kg/Mtr.

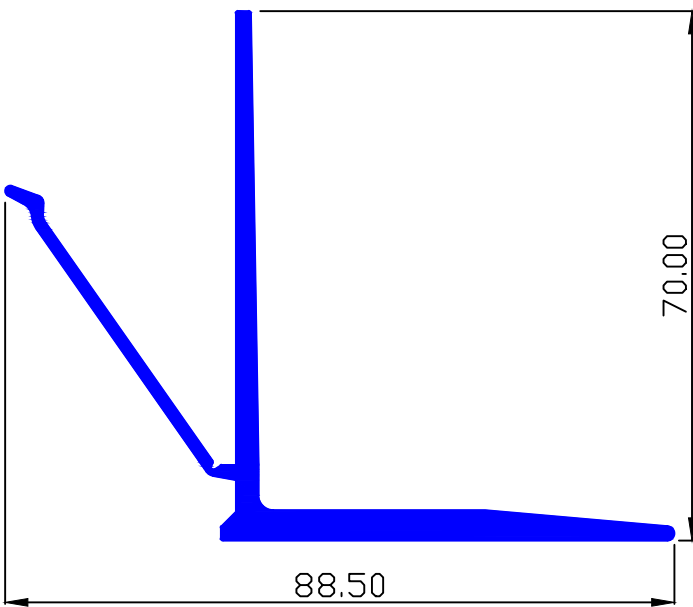

MAAN SEC.- 91144

0.162 Kg/Mtr.

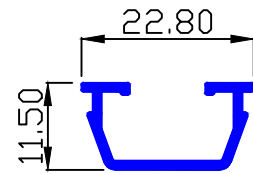

MAAN SEC.- 91145

0.203 Kg/Mtr.

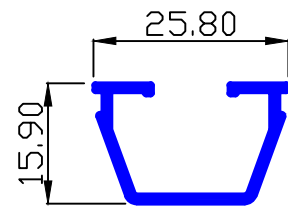

MAAN SEC.- 91025

2.225 Kg/Mtr.

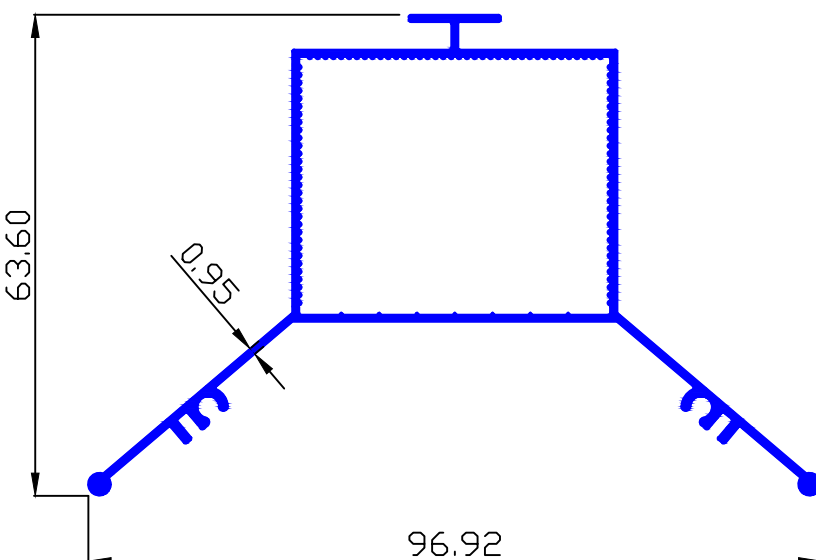

MAAN SEC.- 91146

0.224 Kg/Mtr.

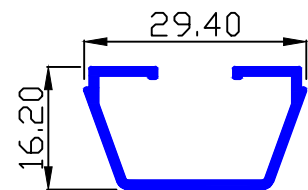

MAAN SEC.- 91147

0.270 Kg/Mtr.

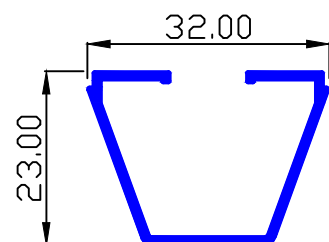



MISCELLANEOUS

MAAN SEC.- 91091

1.091 Kg/Mtr.

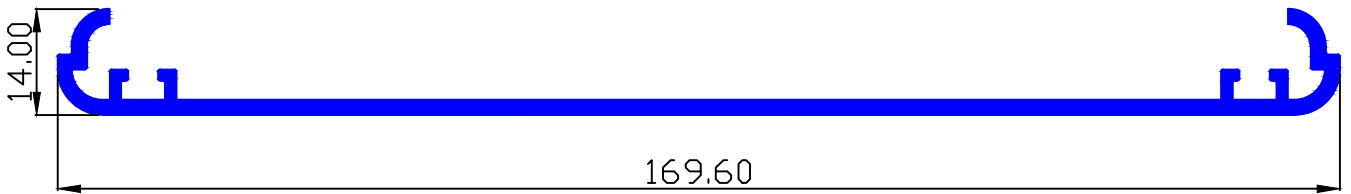

MAAN SEC.- 91025

2.225 Kg/Mtr.

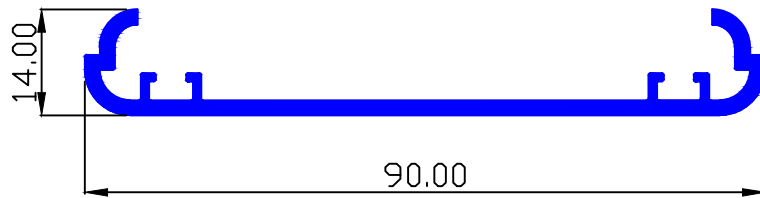

MAAN SEC.- 91127

1.632 Kg/Mtr.

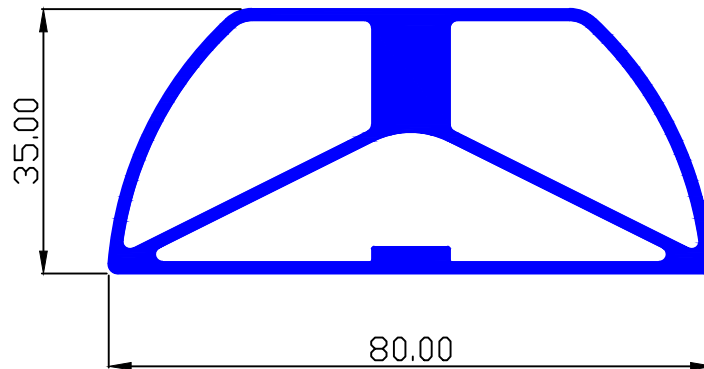

MAAN SEC.- 91141

2.973 Kg/Mtr.

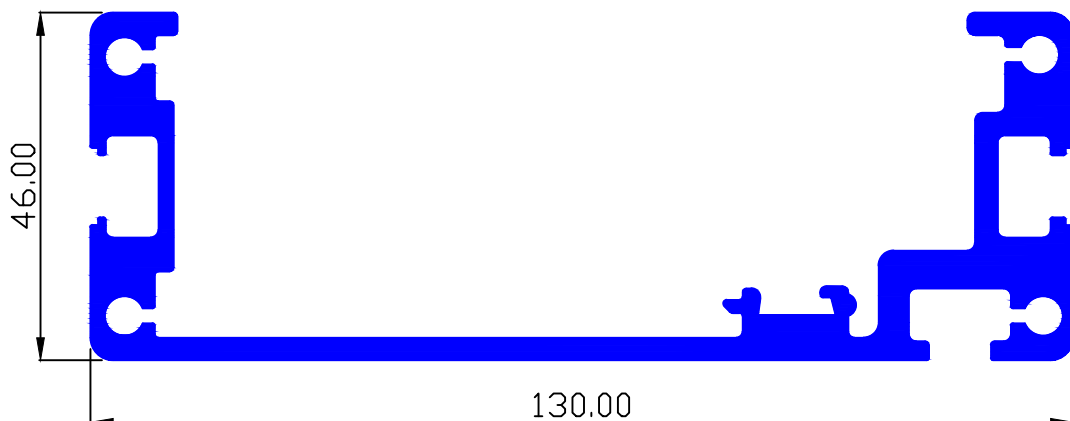



MISCELLANEOUS

MAAN SEC.- 91148

0.503 Kg/Mtr.

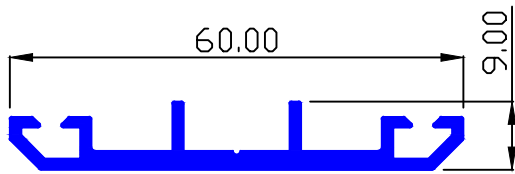

MAAN SEC.- 91158

0.583 Kg/Mtr.

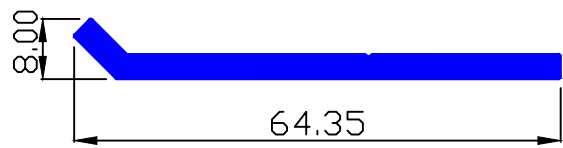

MAAN SEC.- 91190

0.473 Kg/Mtr.

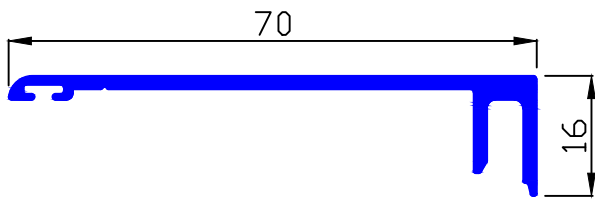

MAAN SEC.- 91205

0.526 Kg/Mtr.

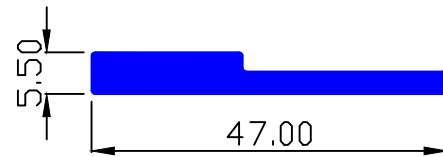

MAAN SEC.- 91157

1.774 Kg/Mtr.

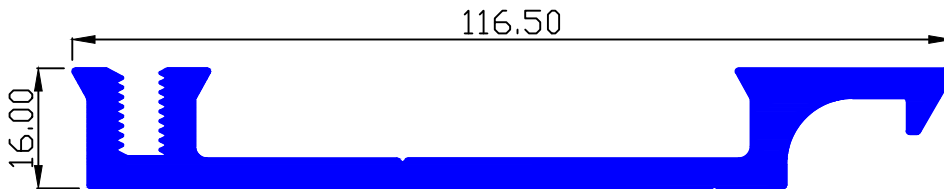

MAAN SEC.- 91159

1.007 Kg/Mtr.

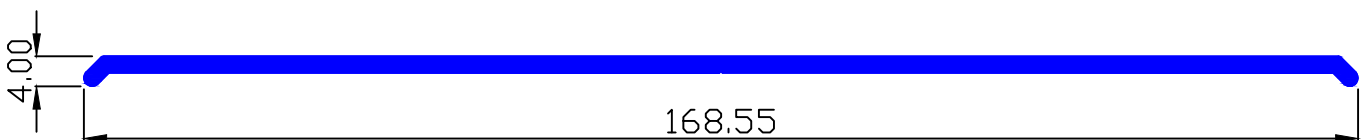

MAAN SEC.- 91160

1.195 Kg/Mtr.

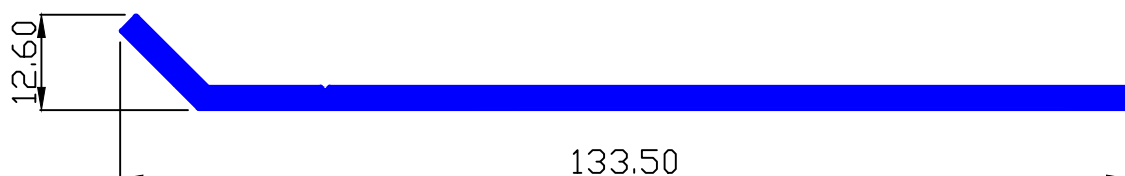



MISCELLANEOUS

MAAN SEC.- 91162

1.771 Kg/Mtr.

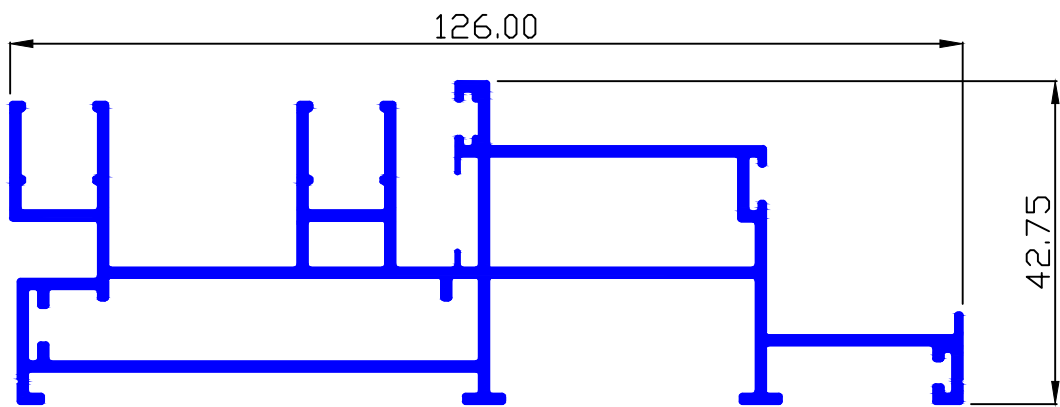

MAAN SEC.- 91207

1.383 Kg/Mtr.

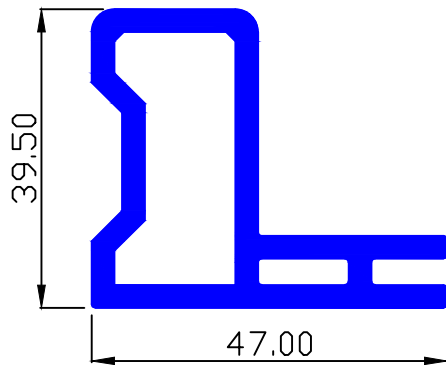

MAAN SEC.- 91196

7.601 Kg/Mtr.

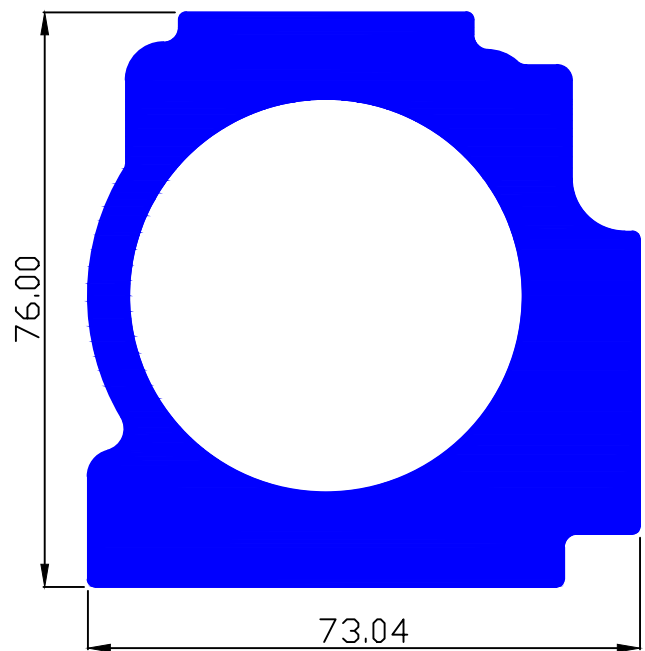

MAAN SEC.- 91206

1.599 Kg/Mtr.

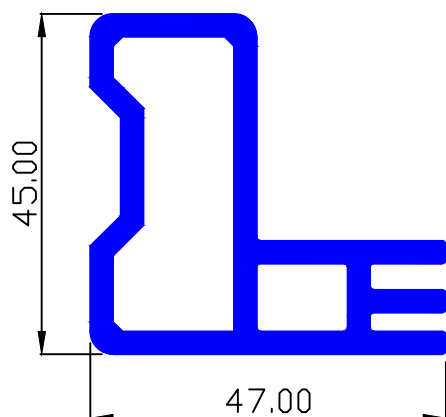



MISCELLANEOUS

MAAN SEC.- 91213

2.296 Kg/Mtr.

76.50

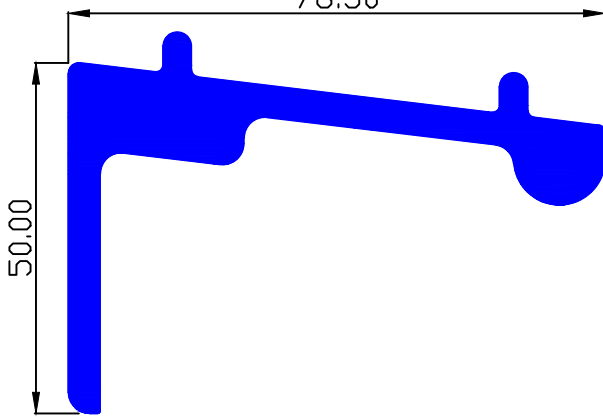

MAAN SEC.- 91214

0.669 Kg/Mtr.

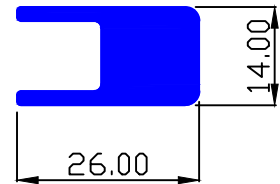

MAAN SEC.- 91215

1.350 Kg/Mtr.

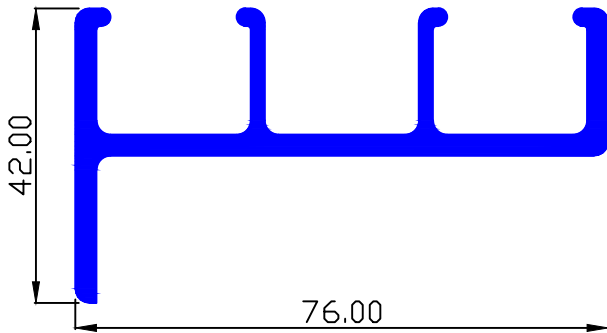

MAAN SEC.- 91230

0.994 Kg/Mtr.

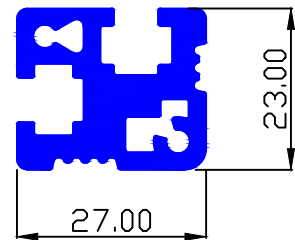

MAAN SEC.- 91216

1.623 Kg/Mtr.

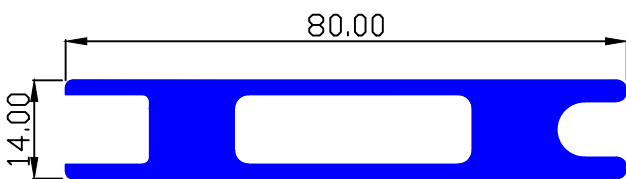

MAAN SEC.- 91231

2.196 Kg/Mtr.

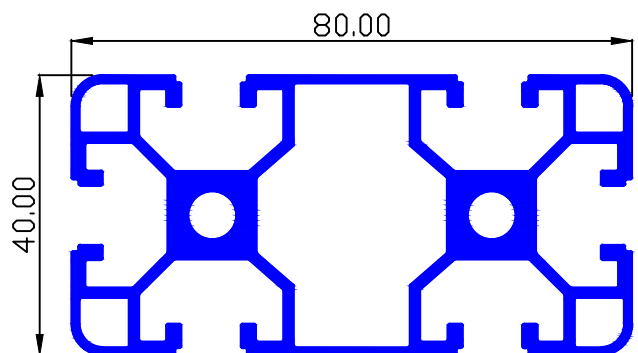



MISCELLANEOUS

MAAN SEC.- 91244

0.302 Kg/Mtr.

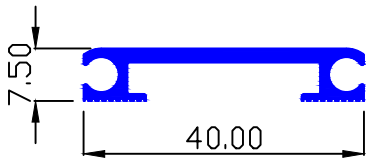

MAAN SEC.- 91248

0.235 Kg/Mtr.

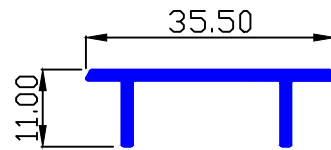

MAAN SEC.- 91263

1.441 Kg/Mtr.

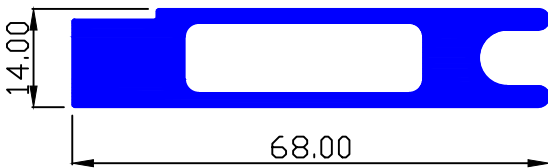

MAAN SEC.- 91264

0.447 Kg/Mtr.

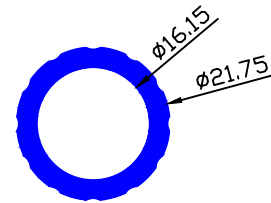

MAAN SEC.- 91268

1.168 Kg/Mtr.

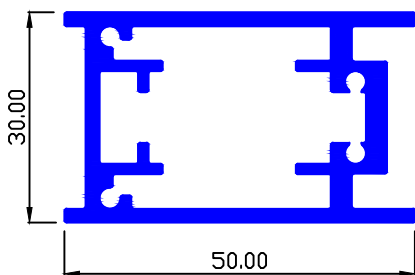

MAAN SEC.- 91271

0.526 Kg/Mtr.

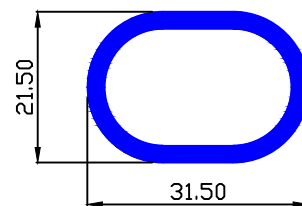

MAAN SEC.- 91272

0.661 Kg/Mtr.

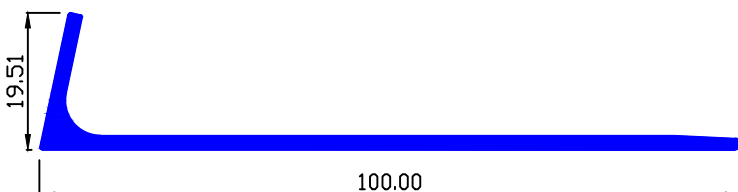



MISCELLANEOUS

MAAN SEC.- 91276

2.373 Kg/Mtr.

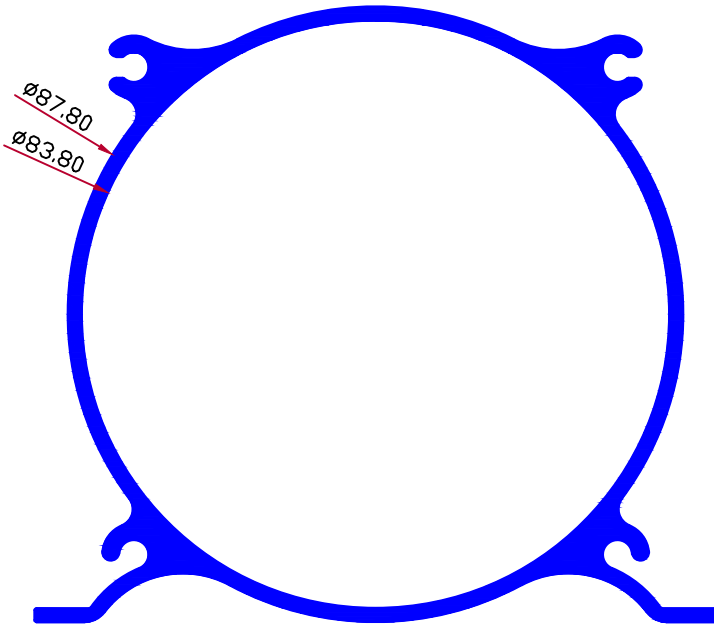

MAAN SEC.- 91282

0.668 Kg/Mtr.

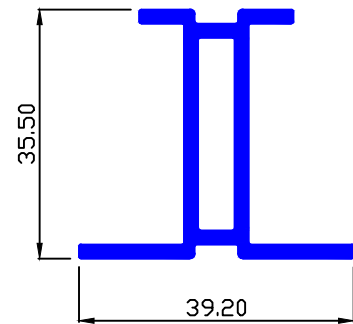

MAAN SEC.- 91277

2.107 Kg/Mtr.

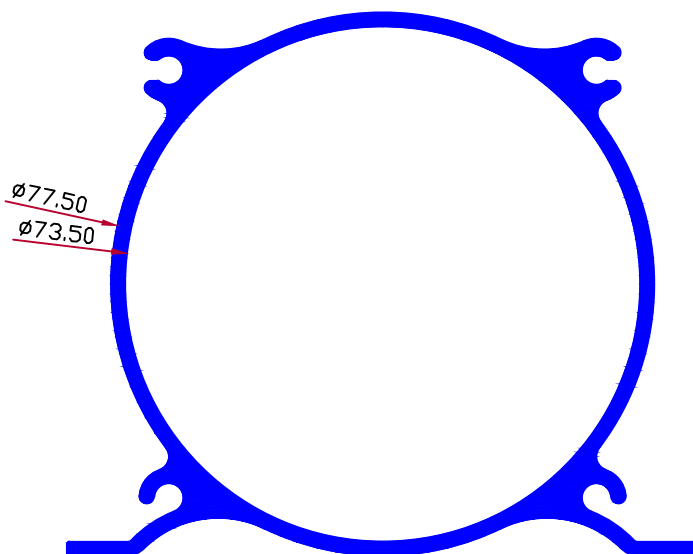

MAAN SEC.- 91268

1.168 Kg/Mtr.

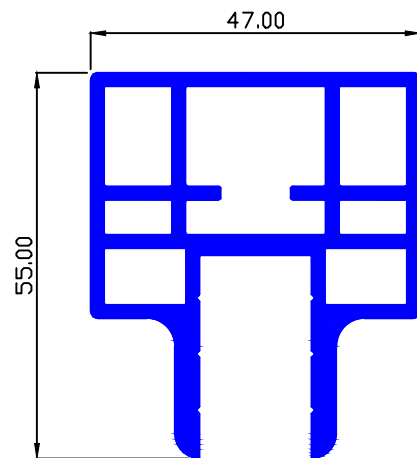



MISCELLANEOUS

MAAN SEC.- 91308

0.358 Kg/Mtr.

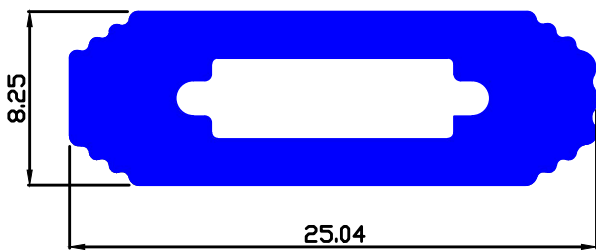

MAAN SEC.- 91318

1.159 Kg/Mtr.

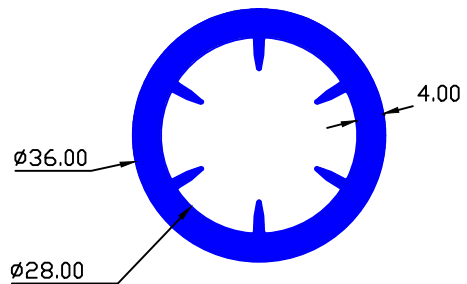

MAAN SEC.- 91348

2.283 Kg/Mtr.

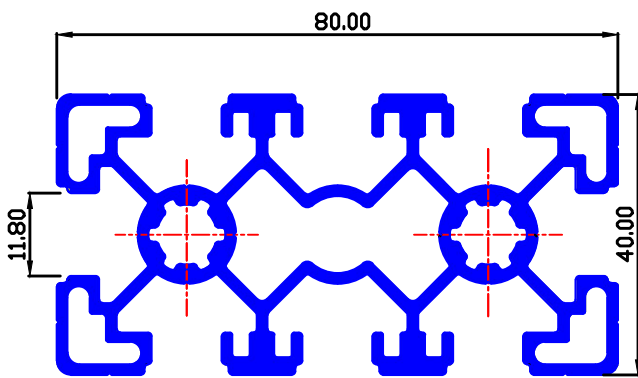

MAAN SEC.- 91376

0.354 Kg/Mtr.

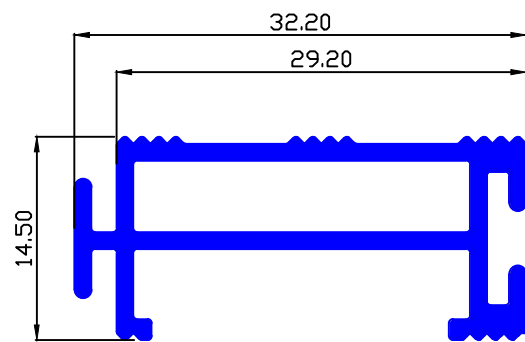

MAAN SEC.- 5796

3.712 Kg/Mtr.

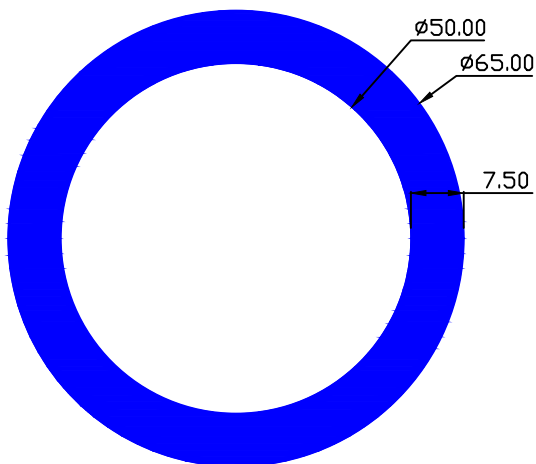

MAAN SEC.- 91314

0.500 Kg/Mtr.

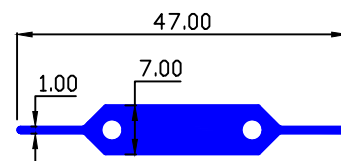



MISCELLANEOUS

MAAN SEC.- 91380

0.359 Kg/Mtr.

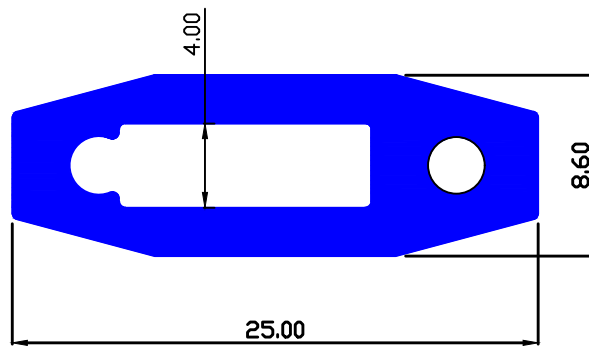

MAAN SEC.- 91482

1.850 Kg/Mtr.

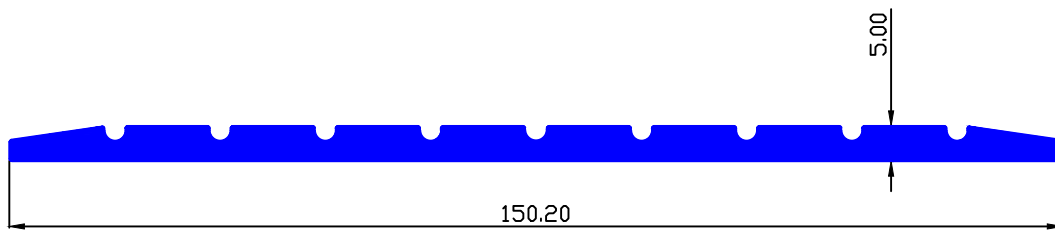



MISCELLANEOUS

MAAN SEC.- 91617

0.247 Kg/Mtr.

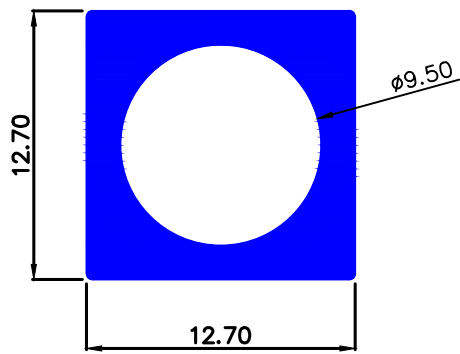

MAAN SEC.- 91627

2.210 Kg/Mtr.

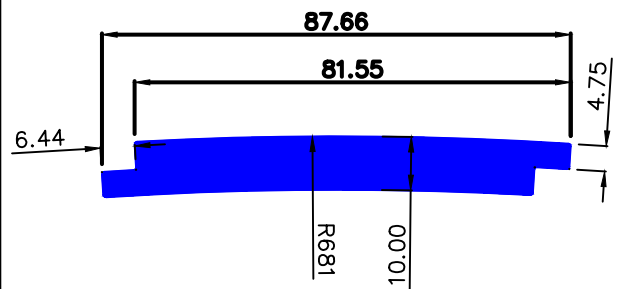

MAAN SEC.- 91628

4.415 Kg/Mtr.

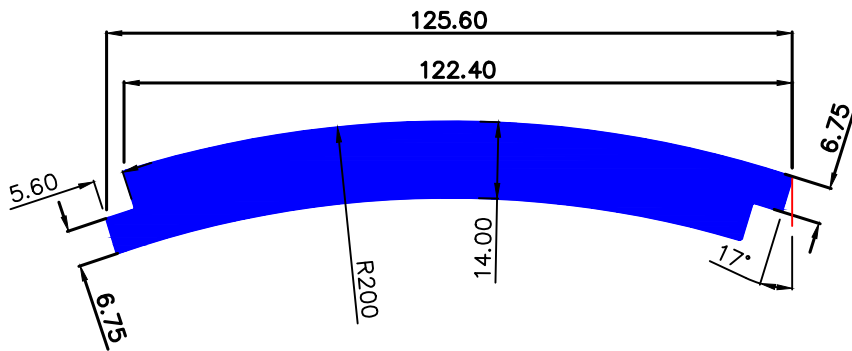

MAAN SEC.- 91651

5.012 Kg/Mtr.

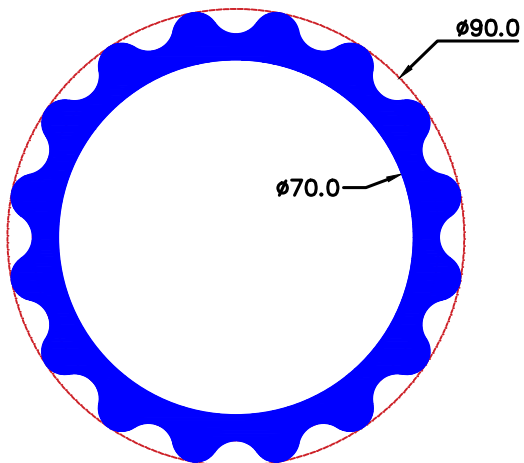

MAAN SEC.- 91652

0.870 Kg/Mtr.

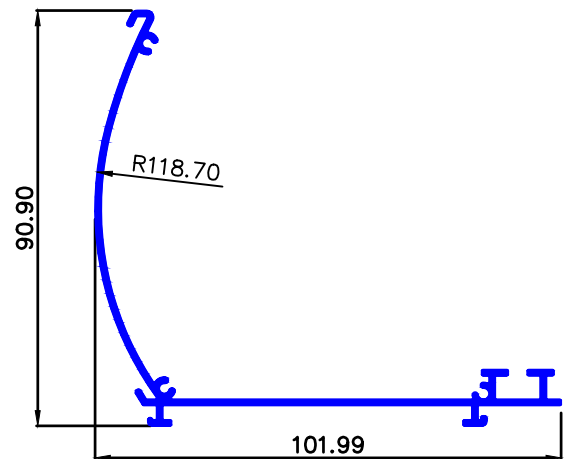



MISCELLANEOUS

MAAN SEC.- 91723

0.145 Kg/Mtr.

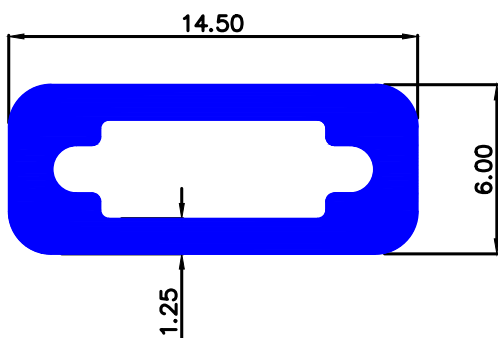

MAAN SEC.- 91725

0.214 Kg/Mtr.

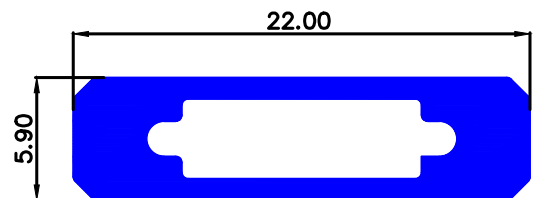

MAAN SEC.- 91729

0.376 Kg/Mtr.

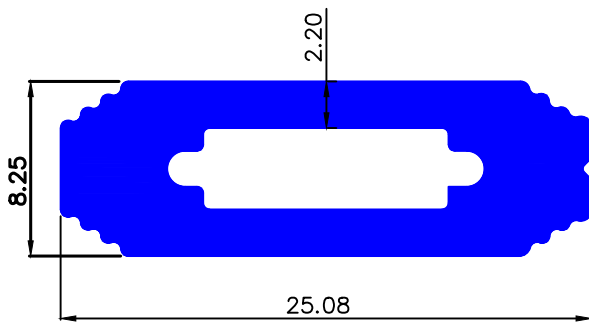

MAAN SEC.- 91737

0.761 Kg/Mtr.

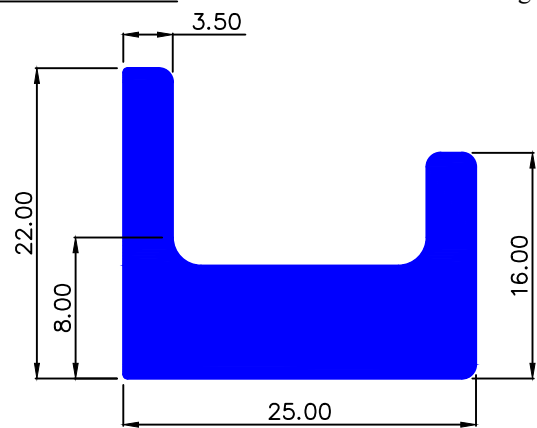

MAAN SEC.- 91785

0.639 Kg/Mtr.

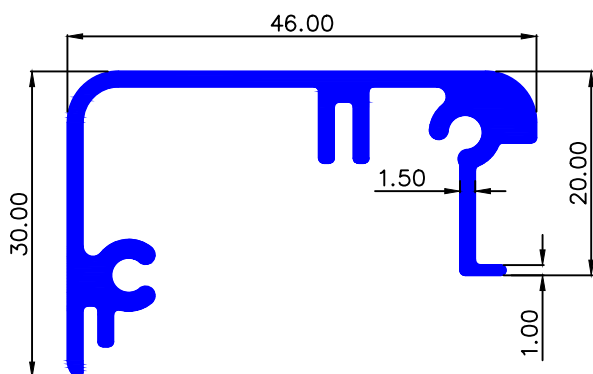

MAAN SEC.- 91789

0.314 Kg/Mtr.

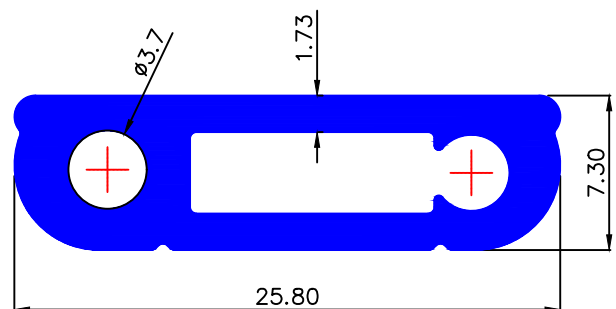



MISCELLANEOUS

MAAN SEC.- 91738

0.315 Kg/Mtr.

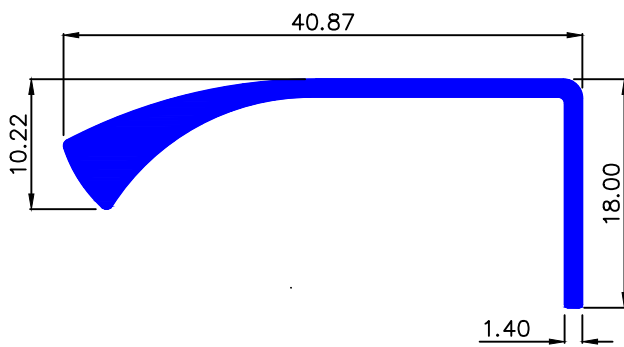

MAAN SEC.- 91757

0.356 Kg/Mtr.

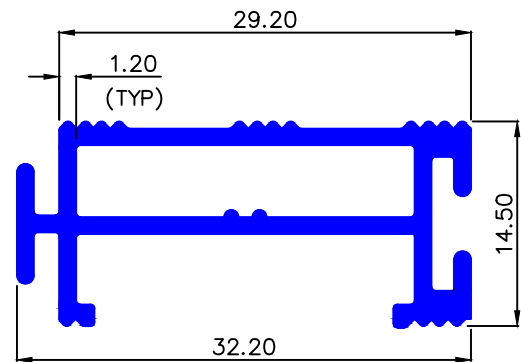

MAAN SEC.- 91758

0.332 Kg/Mtr.

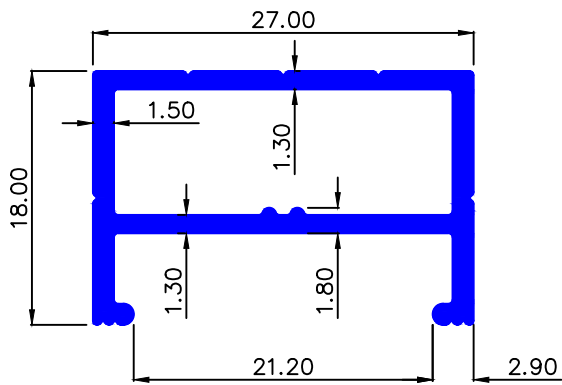

MAAN SEC.- 91775

0.670 Kg/Mtr.

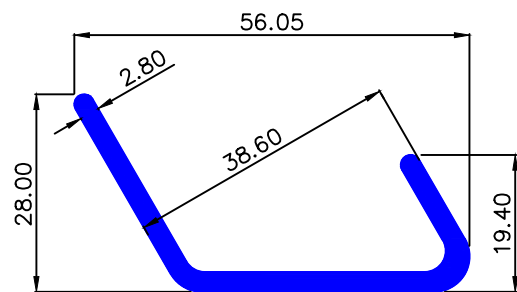

MAAN SEC.- 91776

0.637 Kg/Mtr.

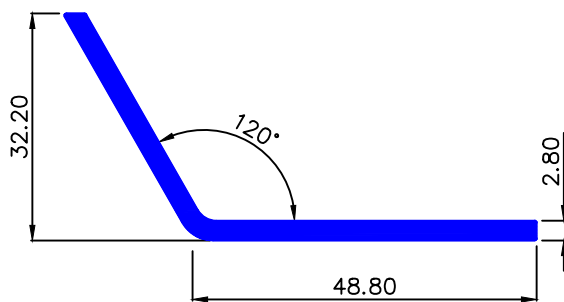

MAAN SEC.- 91777

0.970 Kg/Mtr.

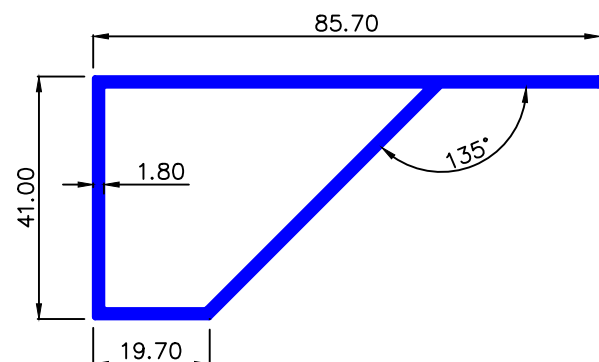



MISCELLANEOUS

MAAN SEC.- 91758

0.332 Kg/Mtr.

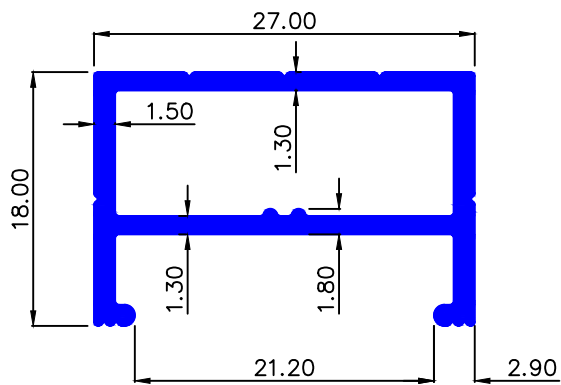

MAAN SEC.- 91780

1.986 Kg/Mtr.

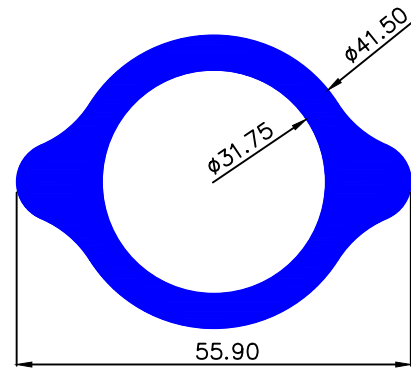

MAAN SEC.- 91788

1.461 Kg/Mtr.

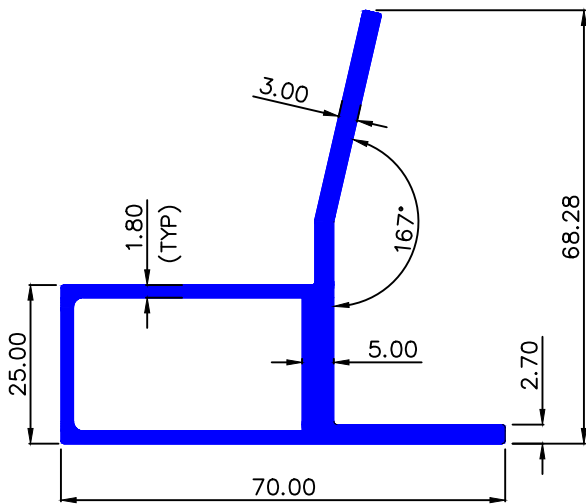

MAAN SEC.- 91828

0.274 Kg/Mtr.

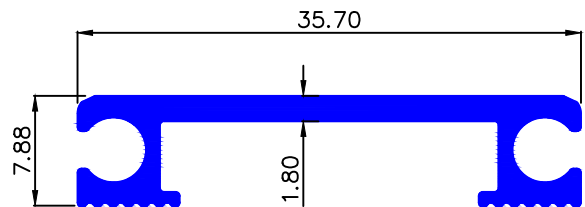

MAAN SEC.- 91847

1.145 Kg/Mtr.

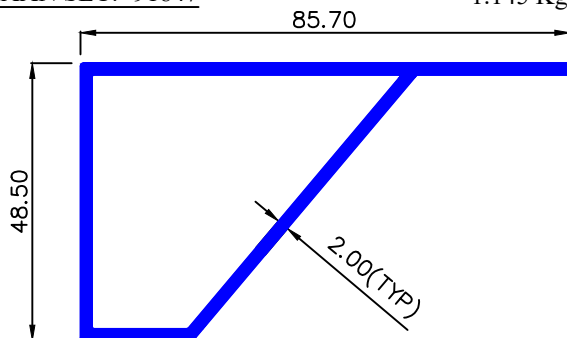

MAAN SEC.- 91872

0.402 Kg/Mtr.

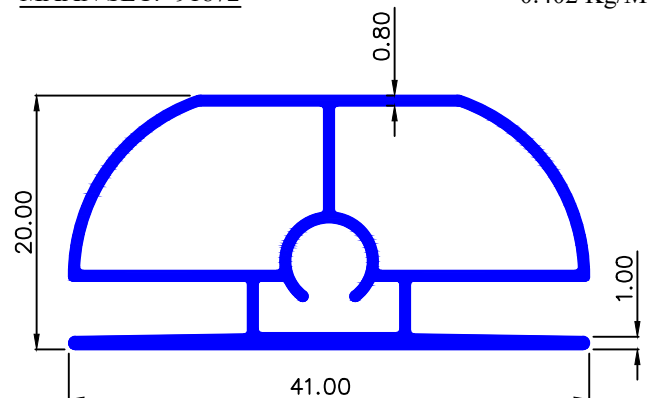



MISCELLANEOUS

MAAN SEC.- 91822

0.196 Kg/Mtr.

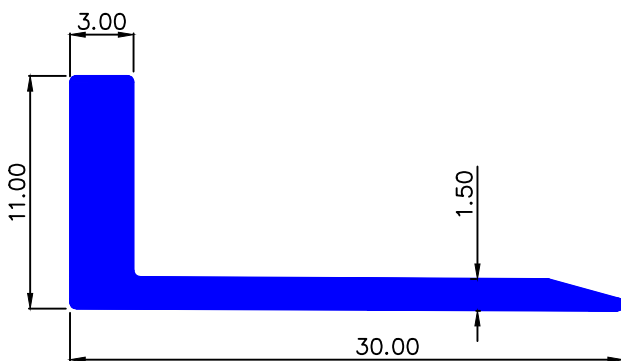

MAAN SEC.- 91823

0.512 Kg/Mtr.

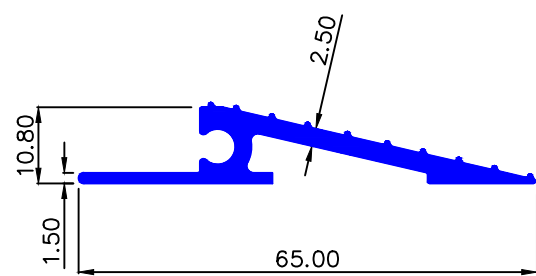

MAAN SEC.- 91824

1.056 Kg/Mtr.

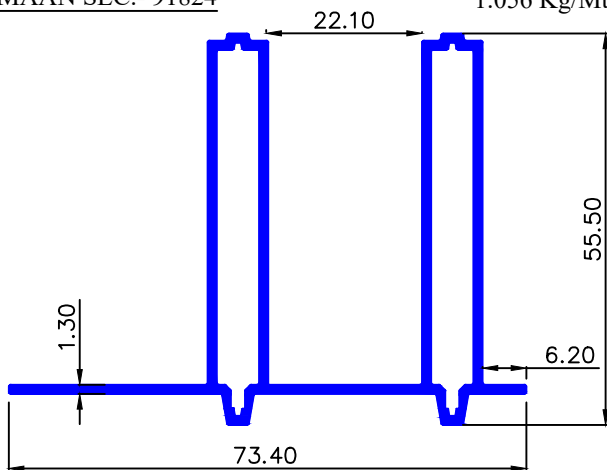

MAAN SEC.- 91844

0.334 Kg/Mtr.

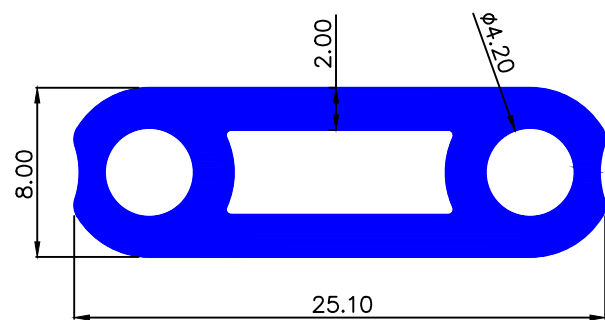

MAAN SEC.- 91846

2.714 Kg/Mtr.

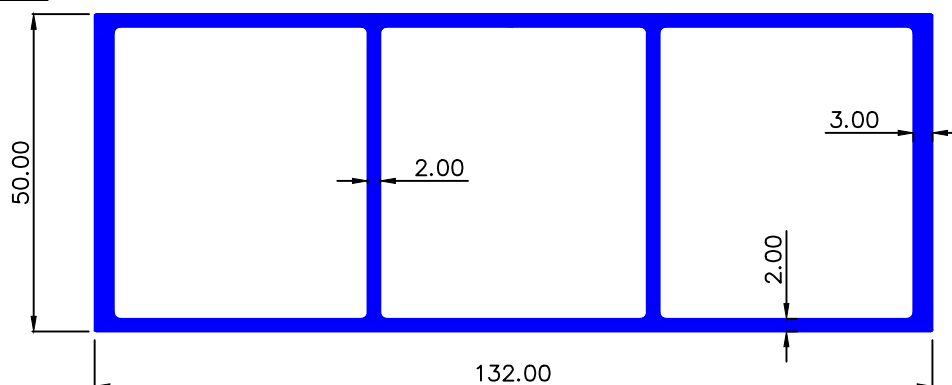



MISCELLANEOUS

MAAN SEC.- 91873

0.507 Kg/Mtr.

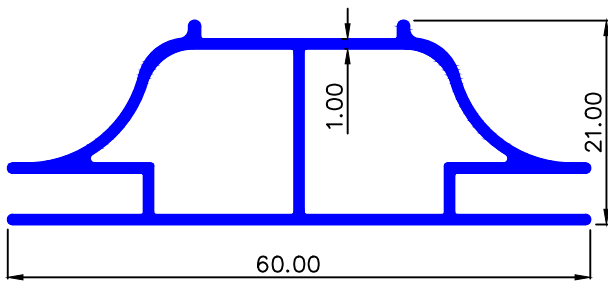

MAAN SEC.- 91894

0.608 Kg/Mtr.

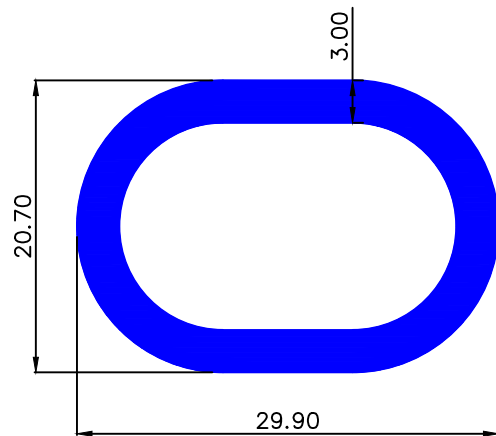

MAAN SEC.- 91897

1.154 Kg/Mtr.

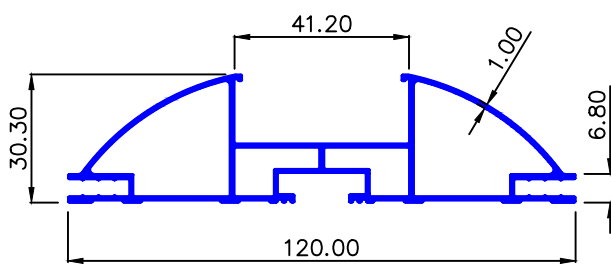

MAAN SEC.- 91898

0.372 Kg/Mtr.

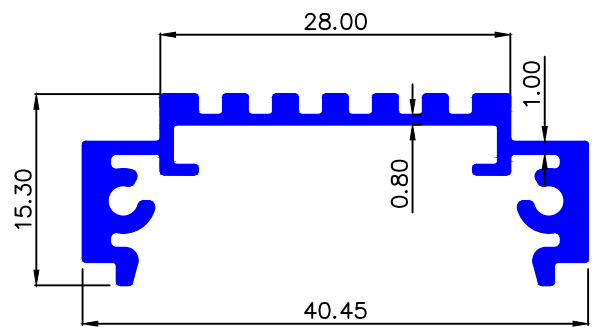



MISCELLANEOUS

MAAN SEC.- 91904

1.980 Kg/Mtr.

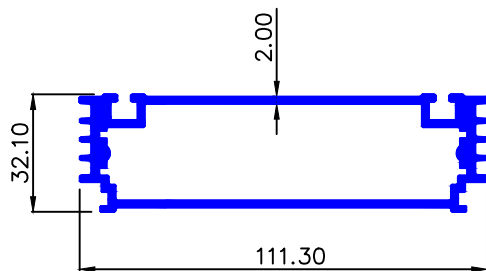

MAAN SEC.- 91913

3.424 Kg/Mtr.

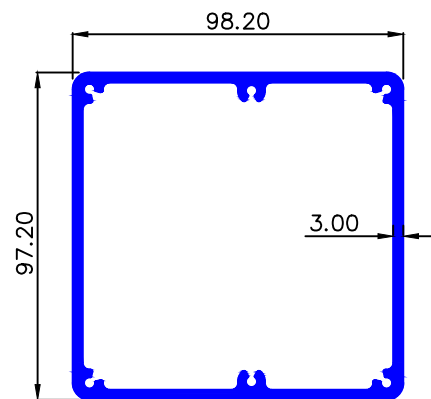

MAAN SEC.- 91918

0.976 Kg/Mtr.

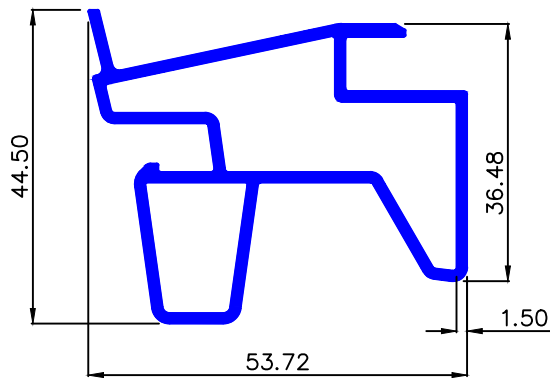

MAAN SEC.- 91919

0.455 Kg/Mtr.

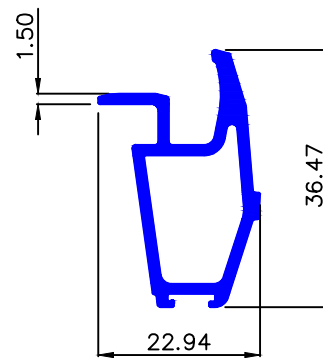

MAAN SEC.- 91972

11.057 Kg/Mtr.

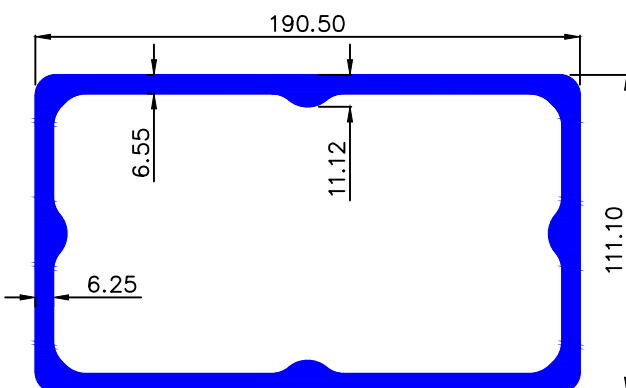

MAAN SEC.- 92016

0.094 Kg/Mtr.

