

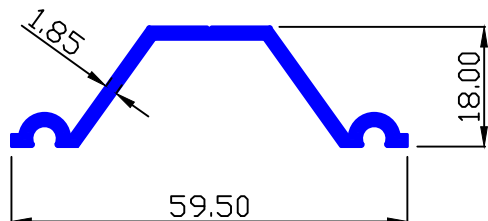

STRUCTURE GLAZING

MAAN SEC.-6842

0.435 Kg/Mtr.



MAAN SEC.-7626

1.052 Kg/Mtr.

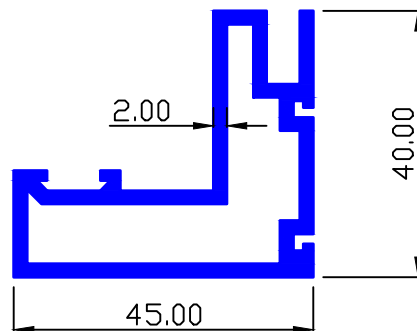

MAAN SEC.-7645

1.975 Kg/Mtr.

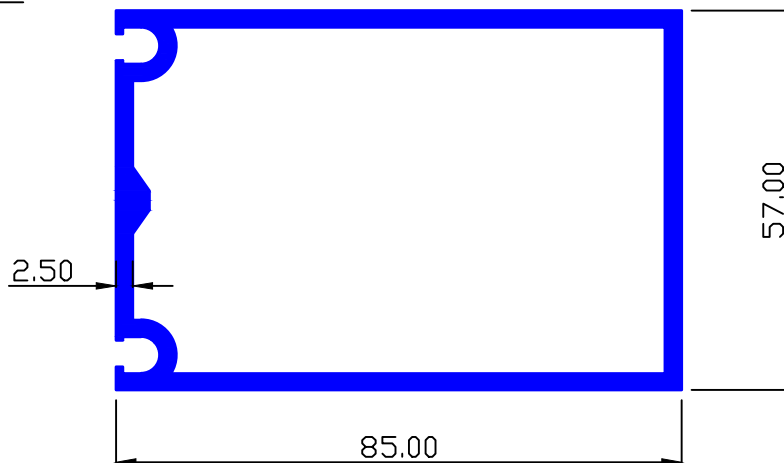

MAAN SEC.-7655

0.732 Kg/Mtr.

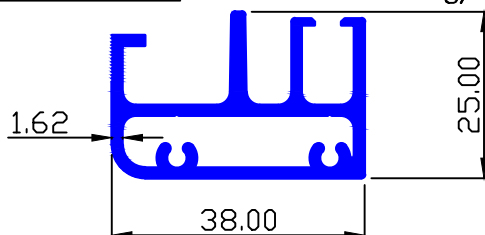

MAAN SEC.-7657

0.255 Kg/Mtr.

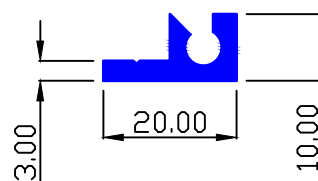

MAAN SEC.-7656

0.748 Kg/Mtr.

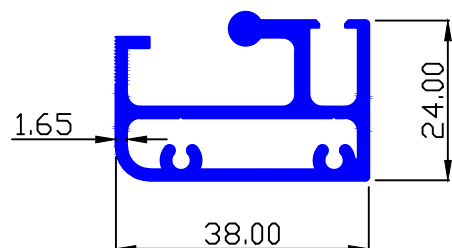

MAAN SEC.-7694

0.185 Kg/Mtr.

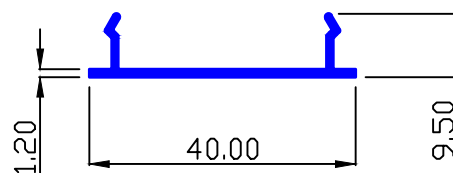



STRUCTURE GLAZING

MAAN SEC.-7688

1.711 Kg/Mtr.

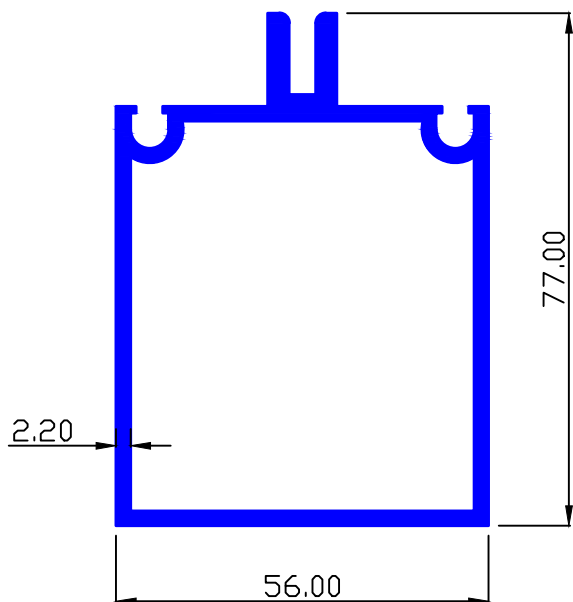

MAAN SEC.-7696

2.477 Kg/Mtr.

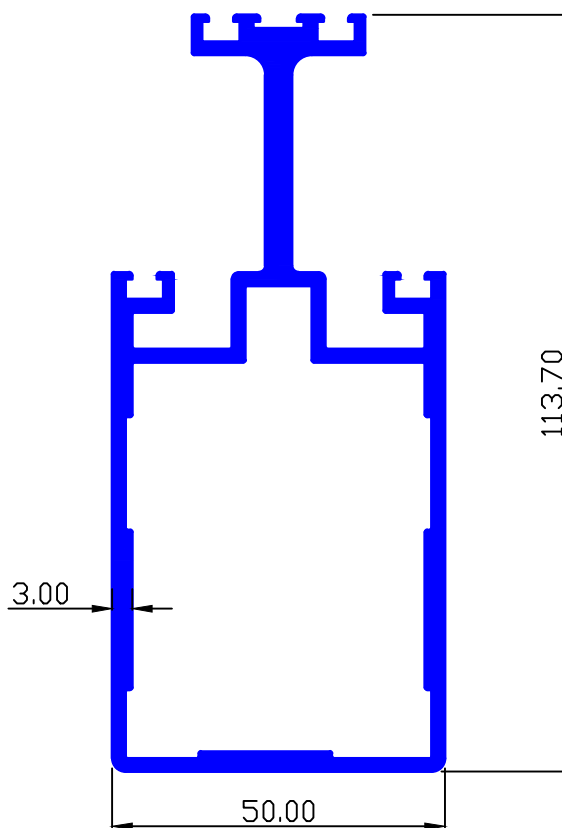

MAAN SEC.-7695

0.386 Kg/Mtr.

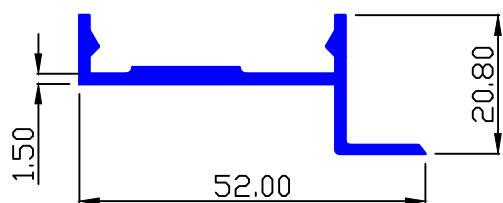

MAAN SEC.-7701

1.142 Kg/Mtr.

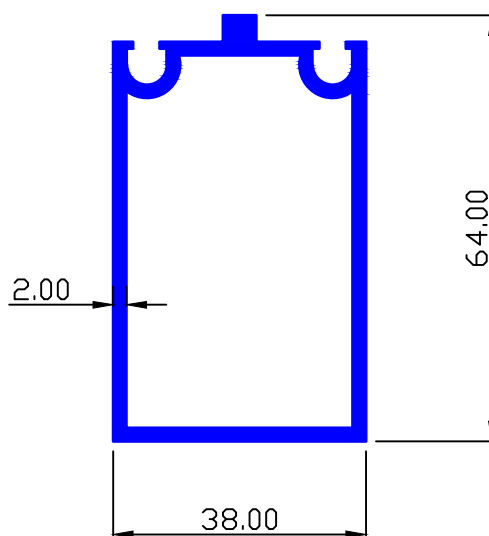

MAAN SEC.-7697

1.449 Kg/Mtr.

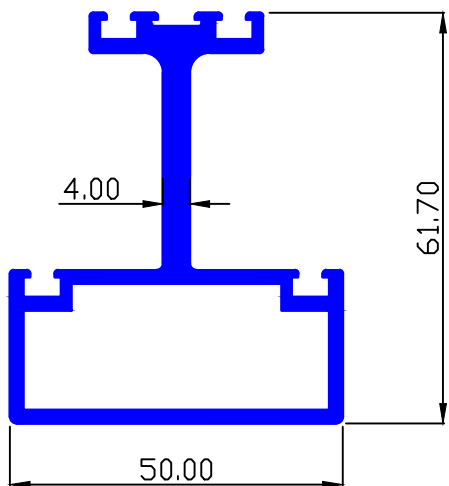



STRUCTURE GLAZING

MAAN SEC.-7702

1.358 Kg/Mtr.

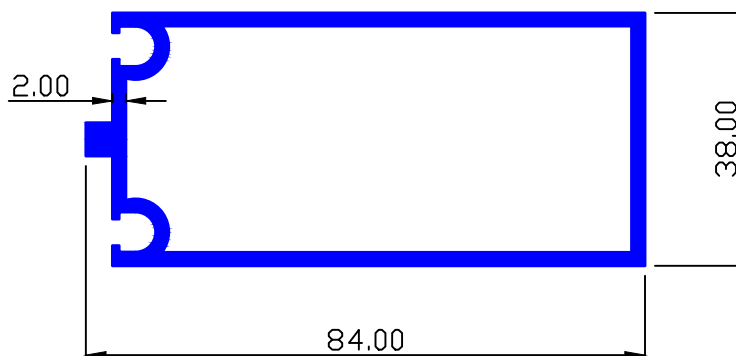

MAAN SEC.-7813

1.330 Kg/Mtr.

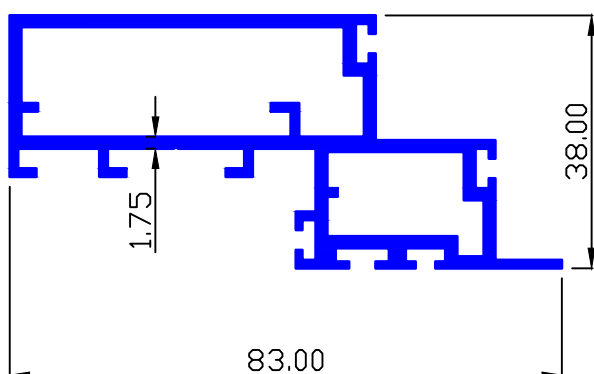

MAAN SEC.-7895

0.816 Kg/Mtr.

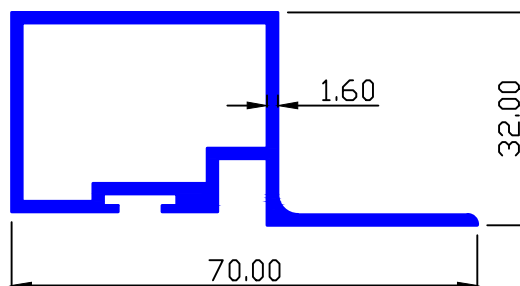

MAAN SEC.-7902

1.064 Kg/Mtr.

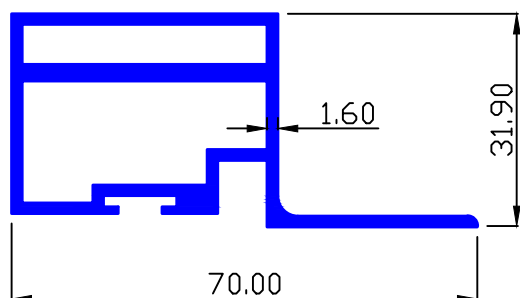

MAAN SEC.-7892

1.060 Kg/Mtr.

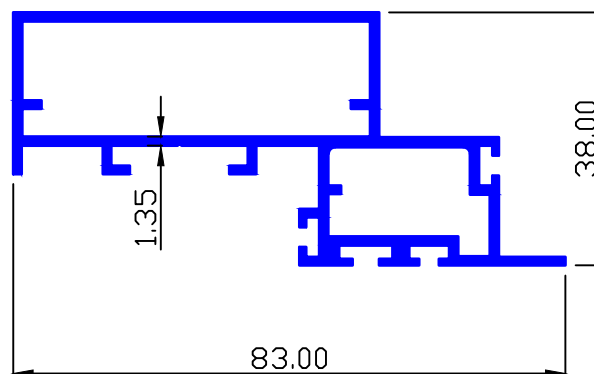

MAAN SEC.-7911

0.073 Kg/Mtr.

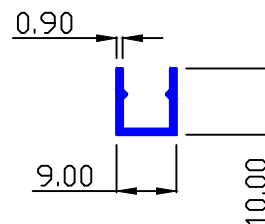



STRUCTURE GLAZING

MAAN SEC.-7912

0.937 Kg/Mtr.

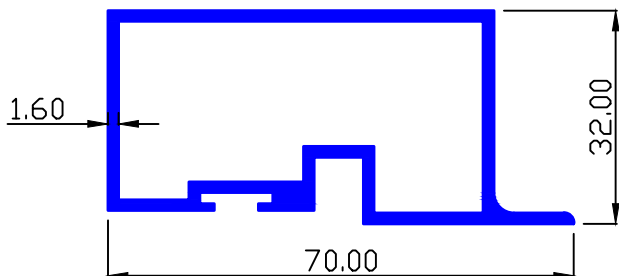

MAAN SEC.-7950

0.261 Kg/Mtr.

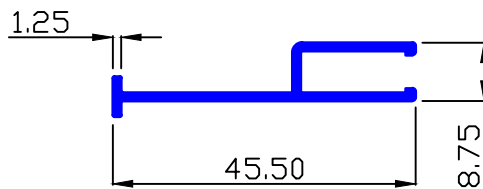

MAAN SEC.-7936

0.805 Kg/Mtr.

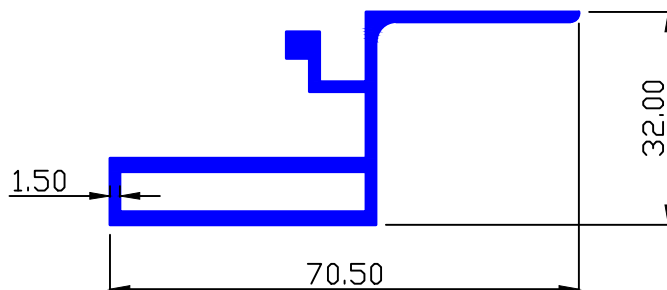

MAAN SEC.-7948

1.424 Kg/Mtr.

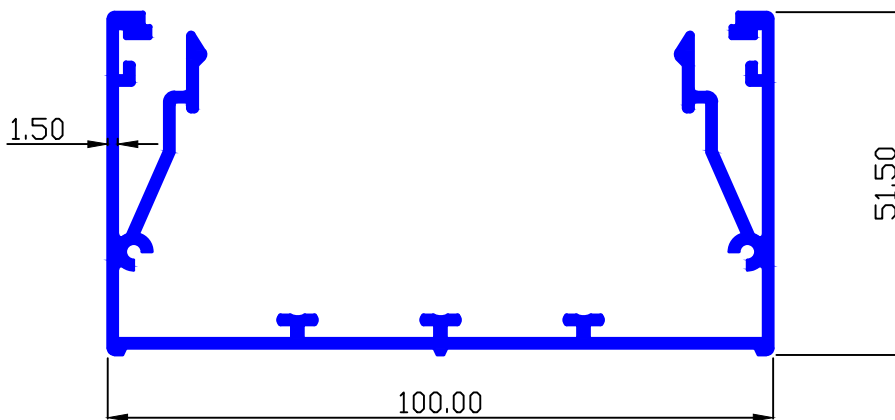

MAAN SEC.-8085

0.665 Kg/Mtr.

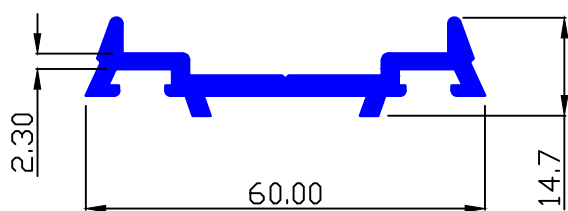

MAAN SEC.-8505

1.220 Kg/Mtr.

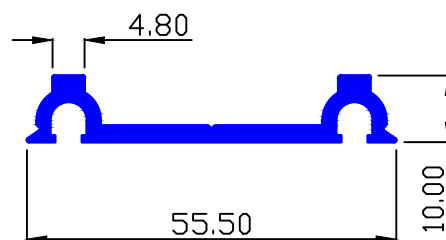



STRUCTURE GLAZING

MAAN SEC.-7949

0.503 Kg/Mtr.

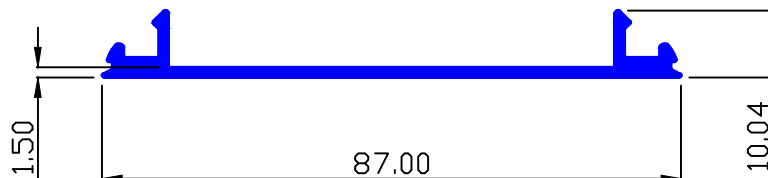

MAAN SEC.-8507

0.338 Kg/Mtr.

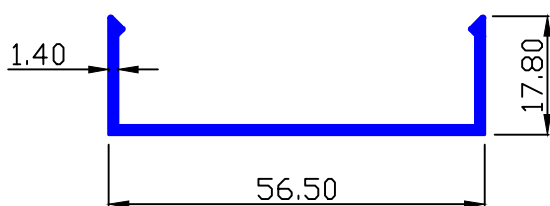

MAAN SEC.-8692

1.904 Kg/Mtr.

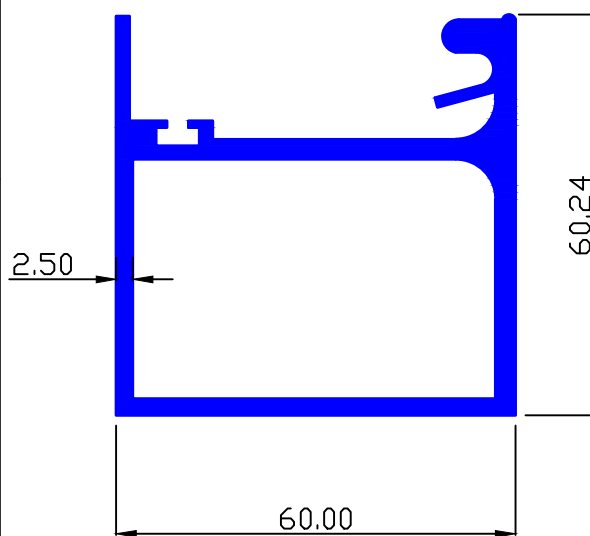

MAAN SEC.-8664

1.103 Kg/Mtr.

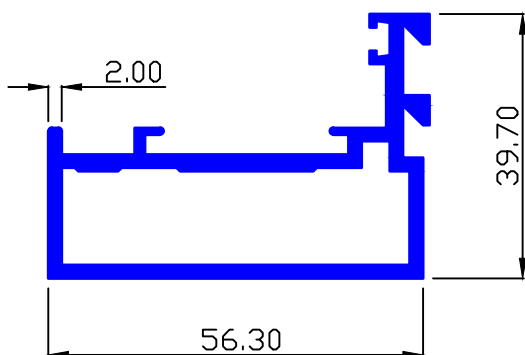

MAAN SEC.-8691

2.738 Kg/Mtr.

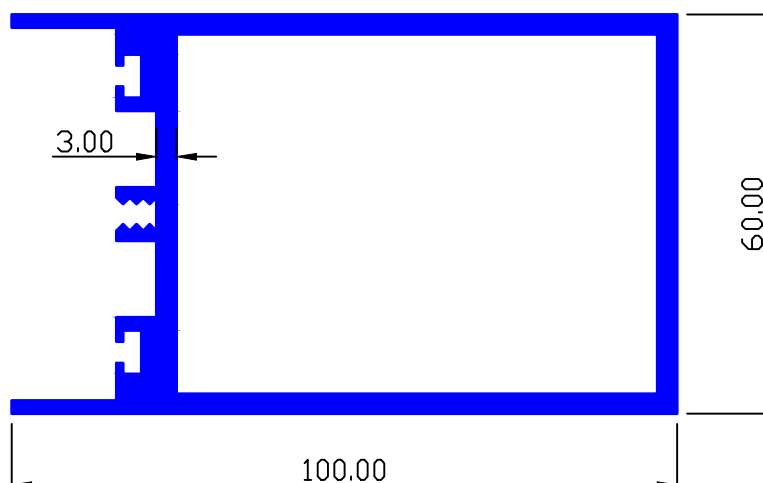



STRUCTURE GLAZING

MAAN SEC.-8693

0.897 Kg/Mtr.

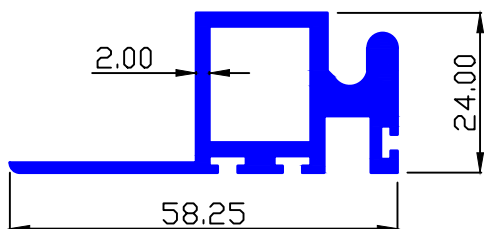

MAAN SEC.-8730

0.450 Kg/Mtr.

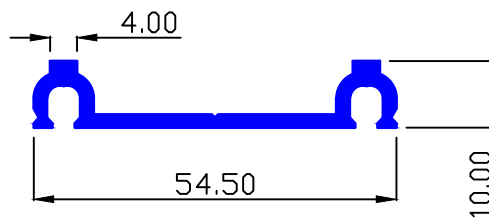

MAAN SEC.-8718

1.214 Kg/Mtr.

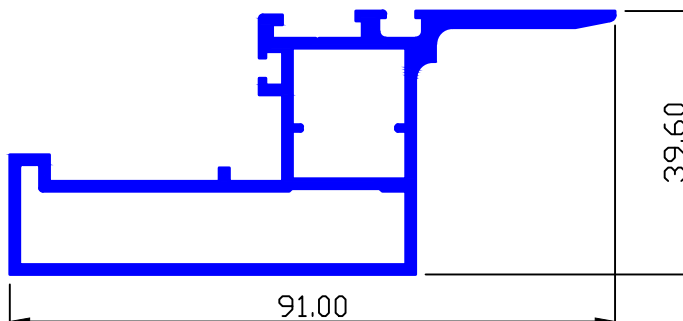

MAAN SEC.-8719

1.225 Kg/Mtr.

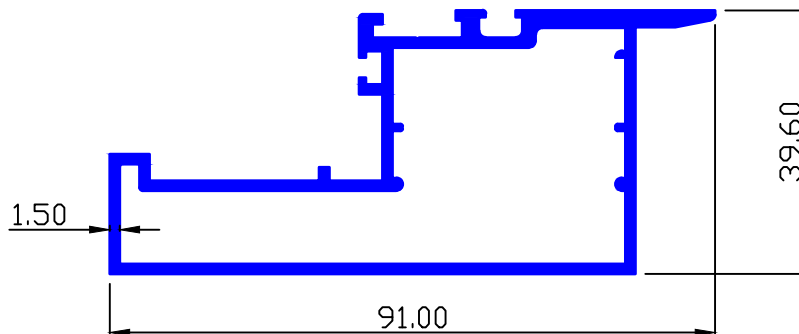

MAAN SEC.-8729

0.739 Kg/Mtr.

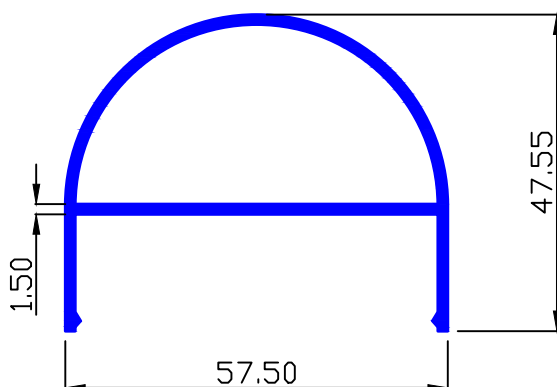

MAAN SEC.-8735

1.285 Kg/Mtr.

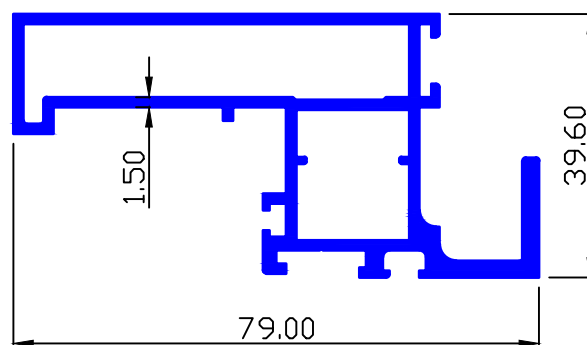



STRUCTURE GLAZING

MAAN SEC.-8753

0.778 Kg/Mtr.

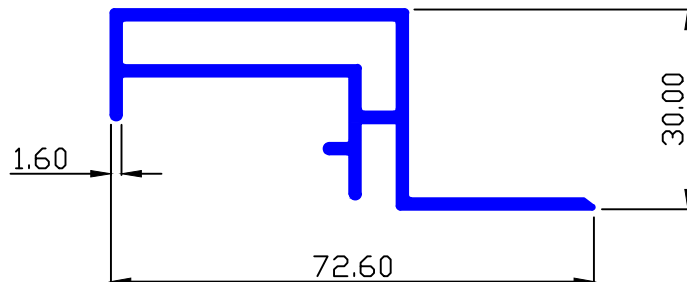

MAAN SEC.-8822

0.483 Kg/Mtr.

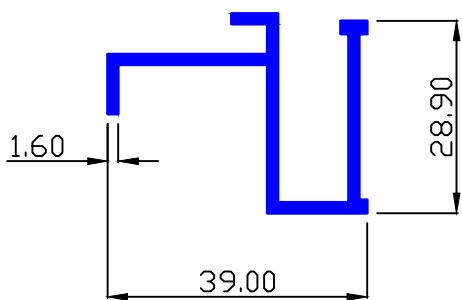

MAAN SEC.-8823

1.059 Kg/Mtr.

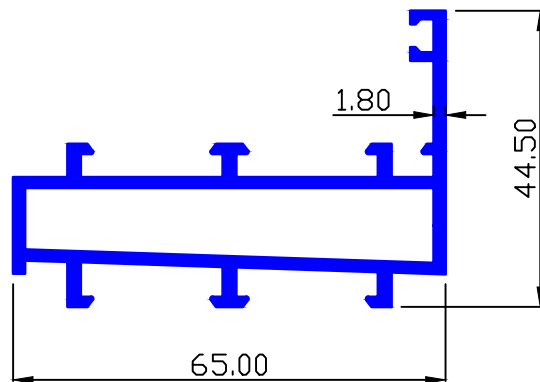

MAAN SEC.-8824

1.198 Kg/Mtr.

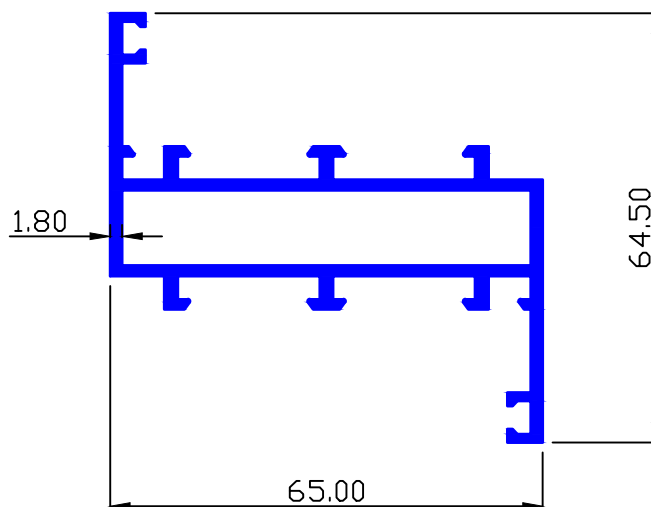



STRUCTURE GLAZING

MAAN SEC.-8825

1.198 Kg/Mtr.

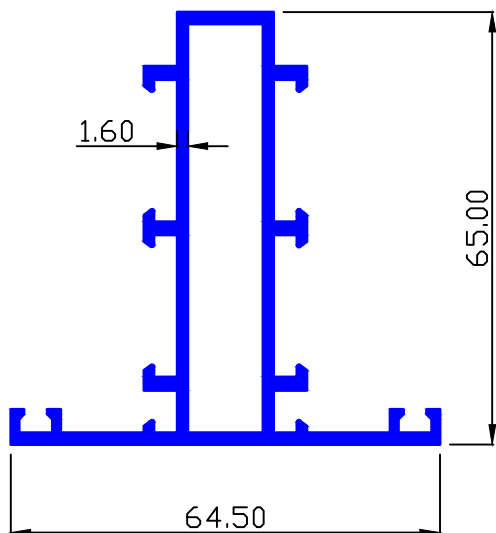

MAAN SEC.-8826

0.506 Kg/Mtr.

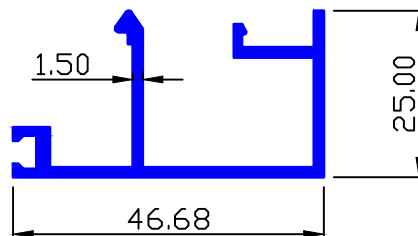

MAAN SEC.-8827

0.422 Kg/Mtr.

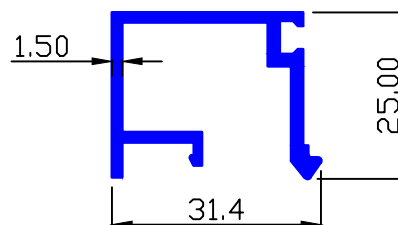

MAAN SEC.-8859

1.659 Kg/Mtr.

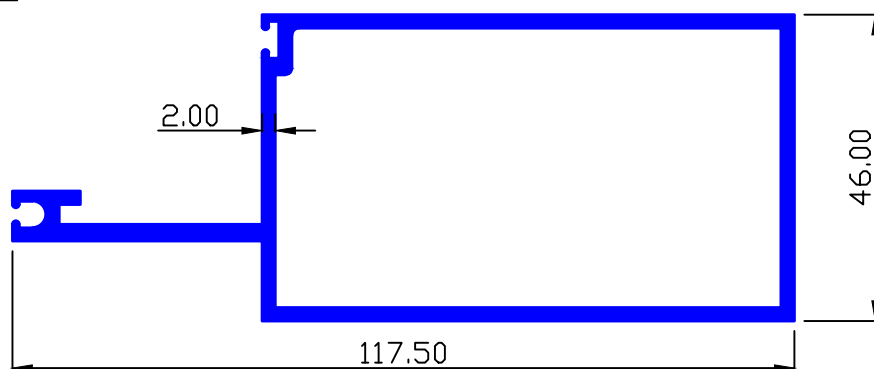

MAAN SEC.-9447

2.446 Kg/Mtr.

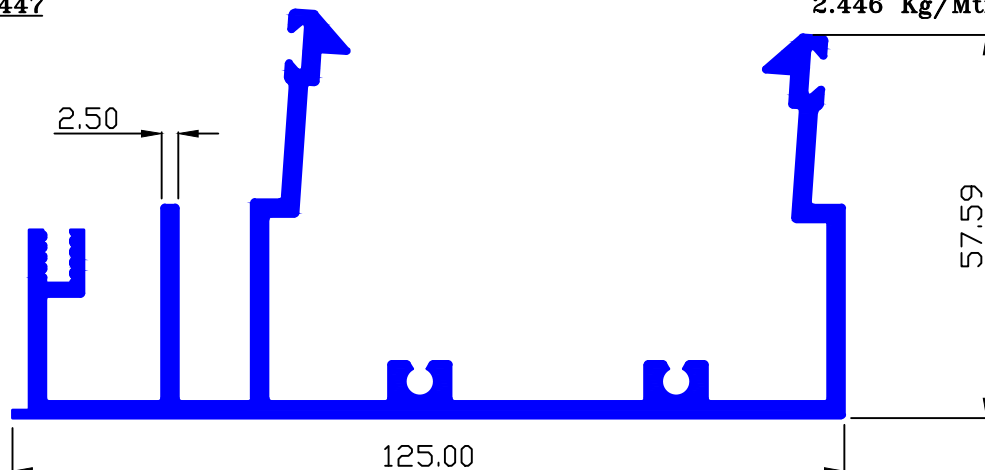



STRUCTURE GLAZING

MAAN SEC.-9448

2.246 Kg/Mtr.

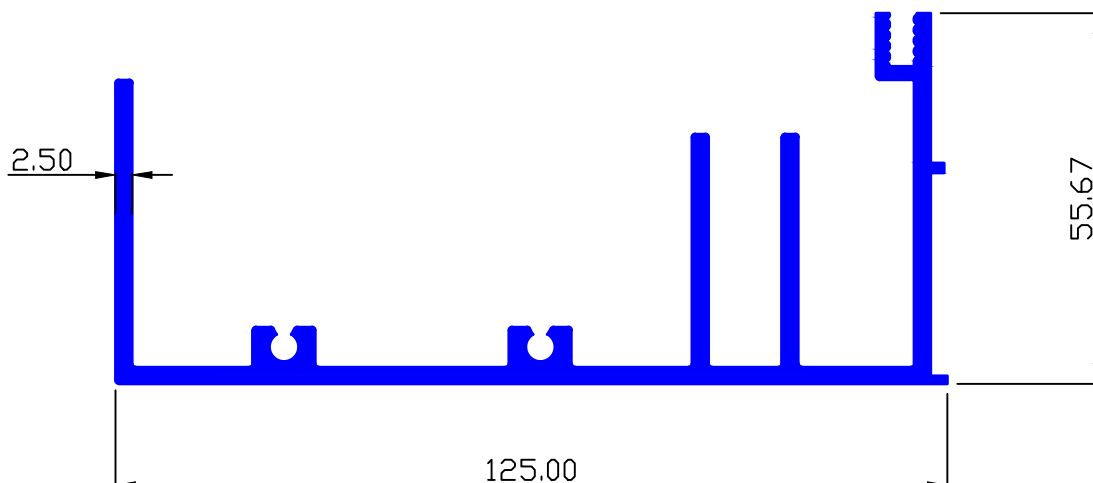

MAAN SEC.-9449

1.856 Kg/Mtr.

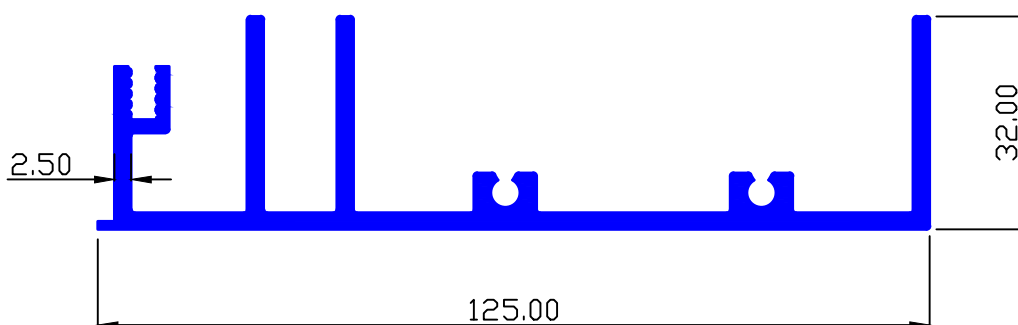

MAAN SEC.-9450

1.897 Kg/Mtr.

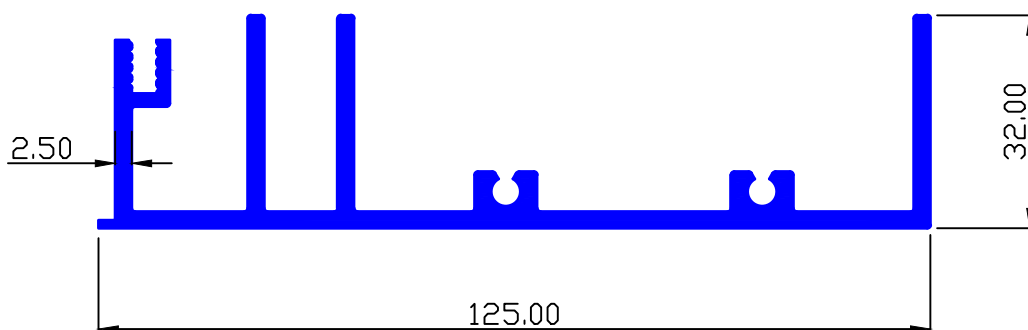



STRUCTURE GLAZING

MAAN SEC.-9451

2.390 Kg/Mtr.

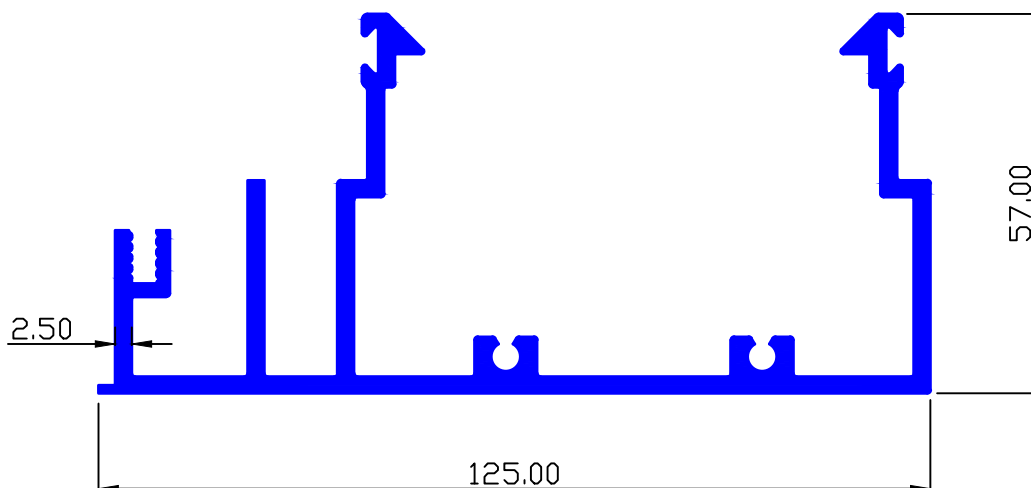

MAAN SEC.-89081

2.362 Kg/Mtr.

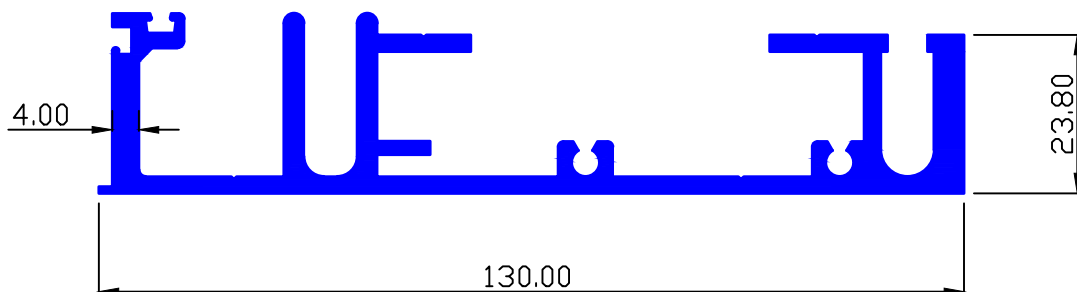

MAAN SEC.-89102

2.351 Kg/Mtr.

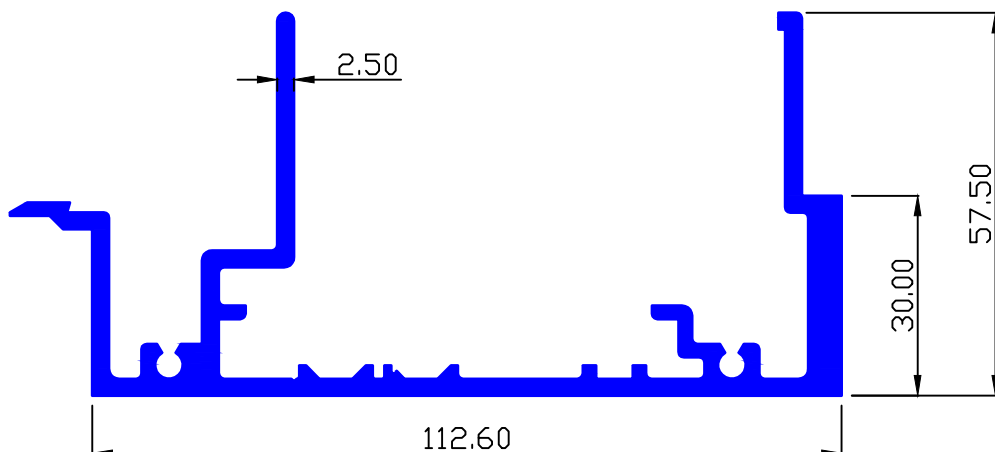



STRUCTURE GLAZING

MAAN SEC.-89103

1.660 Kg/Mtr.

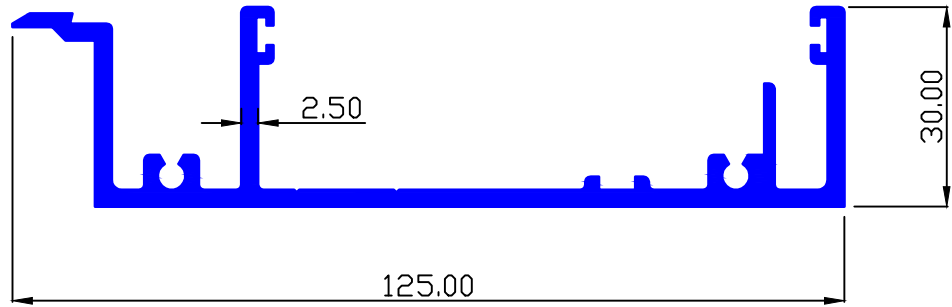

MAAN SEC.-89104

0.260 Kg/Mtr.

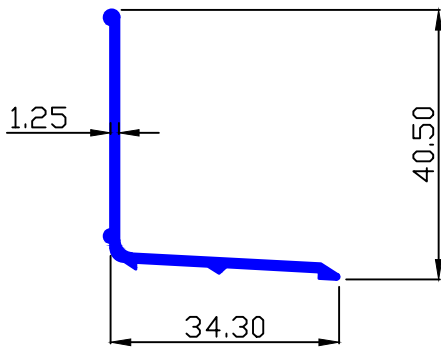

MAAN SEC.-89105

1.697 Kg/Mtr.

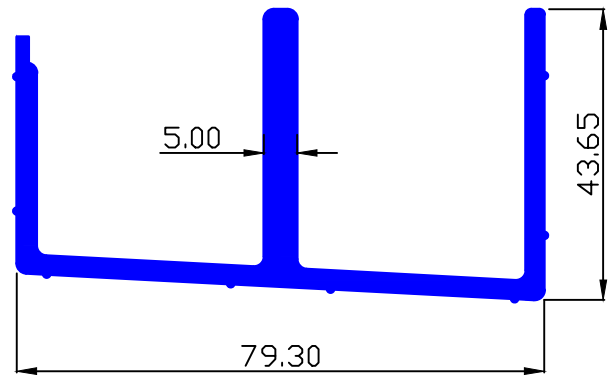

MAAN SEC.-89106

2.624 Kg/Mtr.

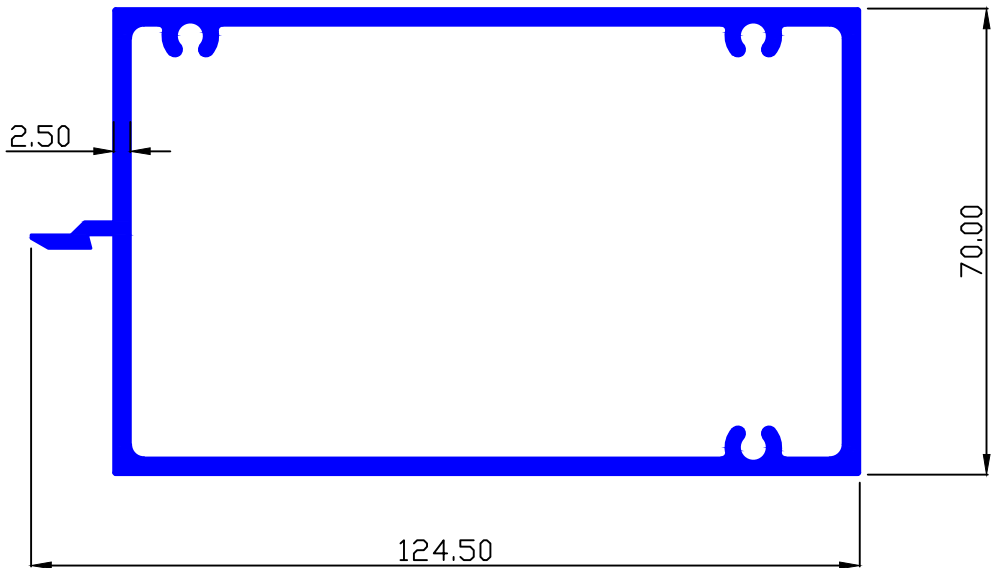



STRUCTURE GLAZING

MAAN SEC.-89107

3.342 Kg/Mtr.

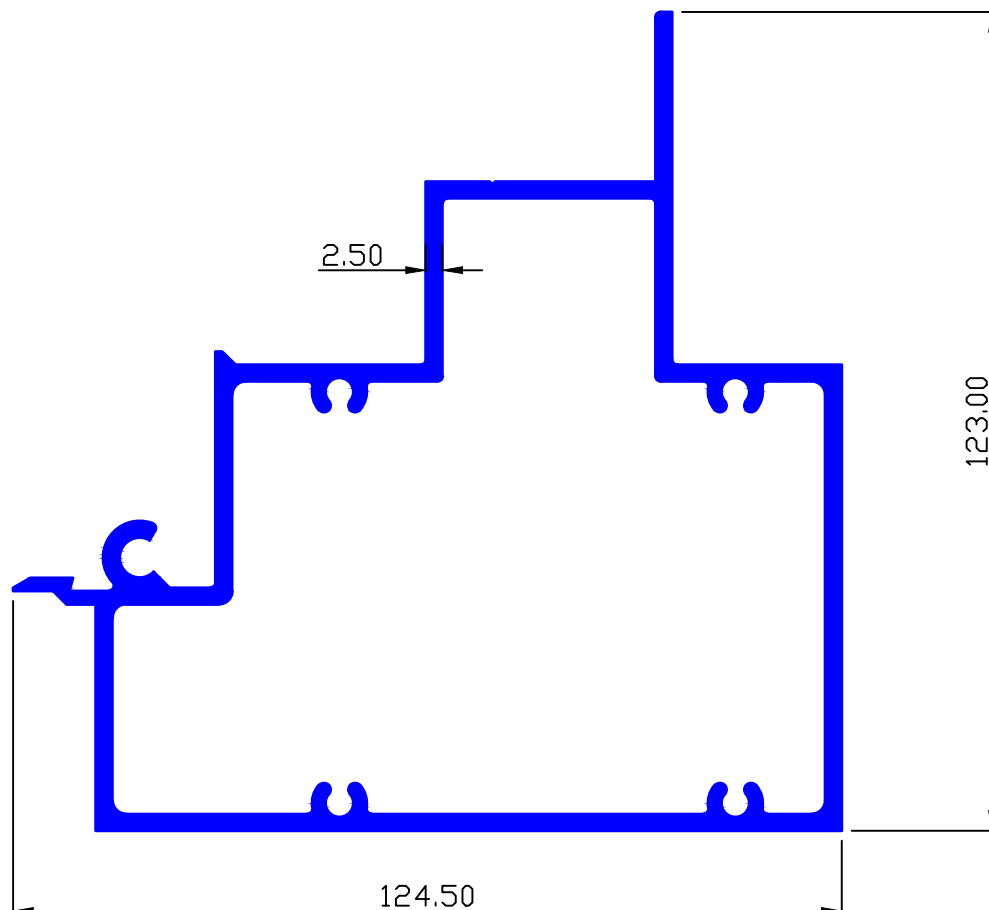

MAAN SEC.-89108

1.861 Kg/Mtr.

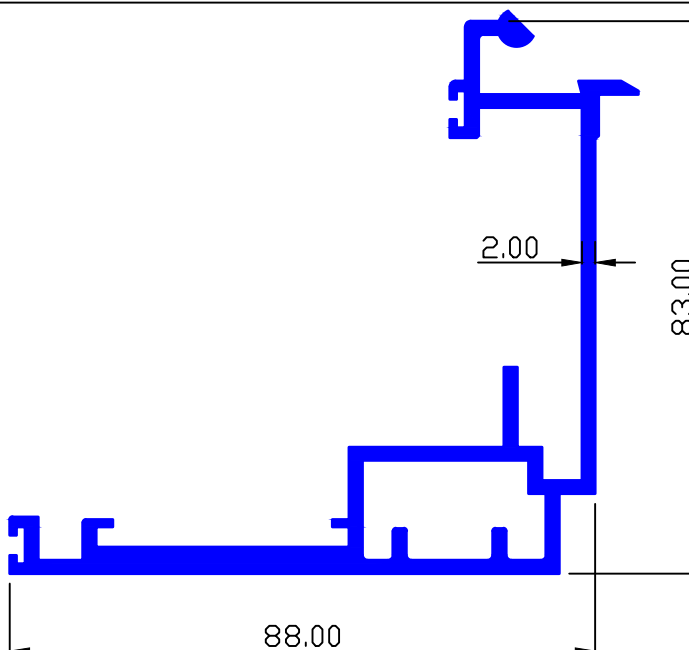



STRUCTURE GLAZING

MAAN SEC.-89112 0.429 Kg/Mtr.

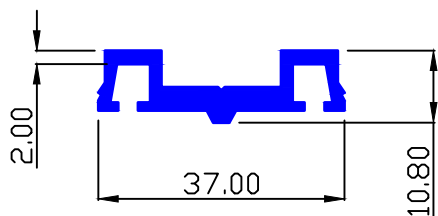

MAAN SEC.-89158 0.353 Kg/Mtr.

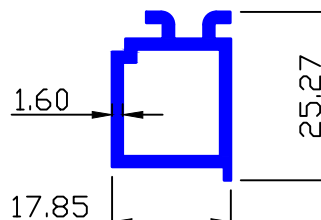

MAAN SEC.-89113 0.251 Kg/Mtr.

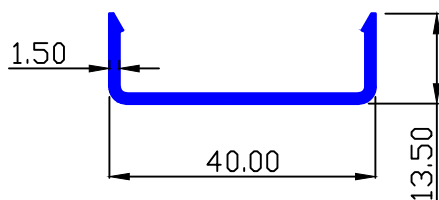

MAAN SEC.-89159 0.673 Kg/Mtr.

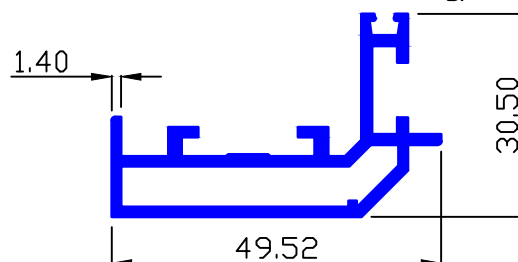

MAAN SEC.-89148 0.120 Kg/Mtr.

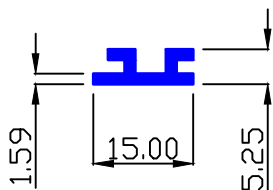

MAAN SEC.-89161 0.405 Kg/Mtr.



MAAN SEC.-89160

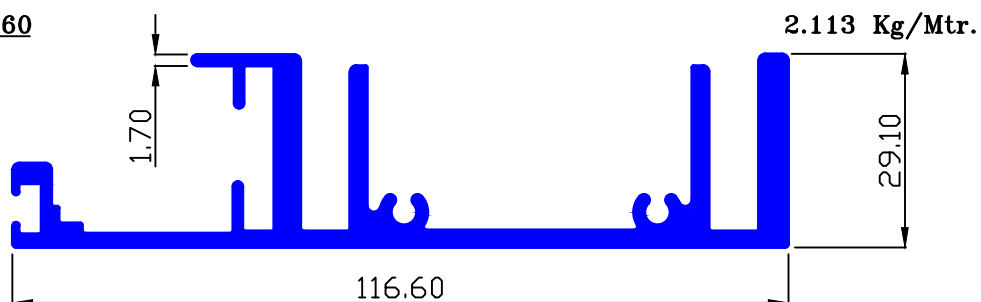

MAAN SEC.-89162

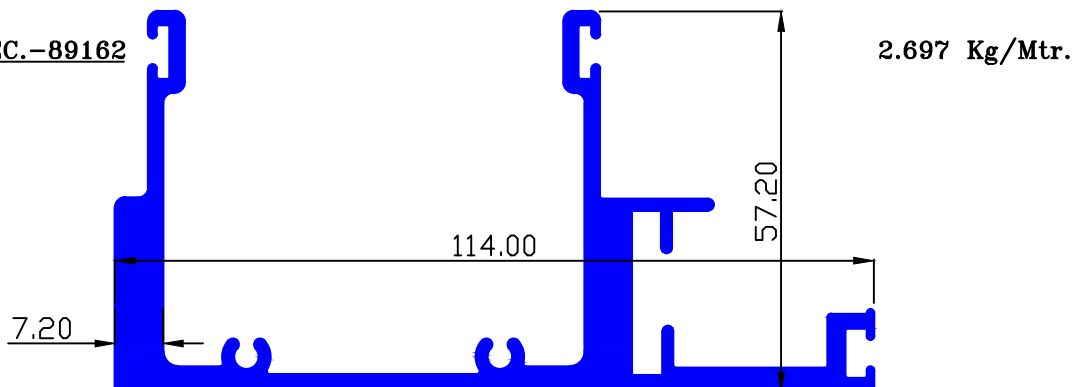



STRUCTURE GLAZING

MAAN SEC.-89193

0.375 Kg/Mtr.

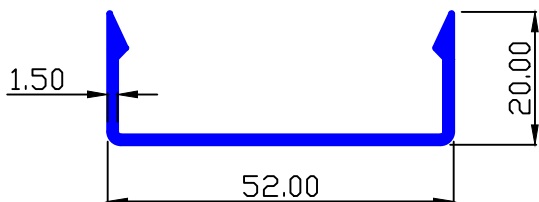

MAAN SEC.-89194

0.562 Kg/Mtr.

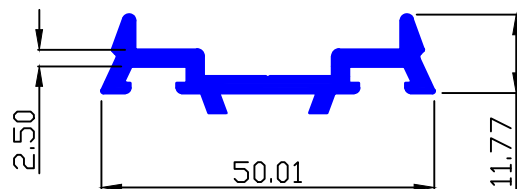

MAAN SEC.-89200

1.384 Kg/Mtr.

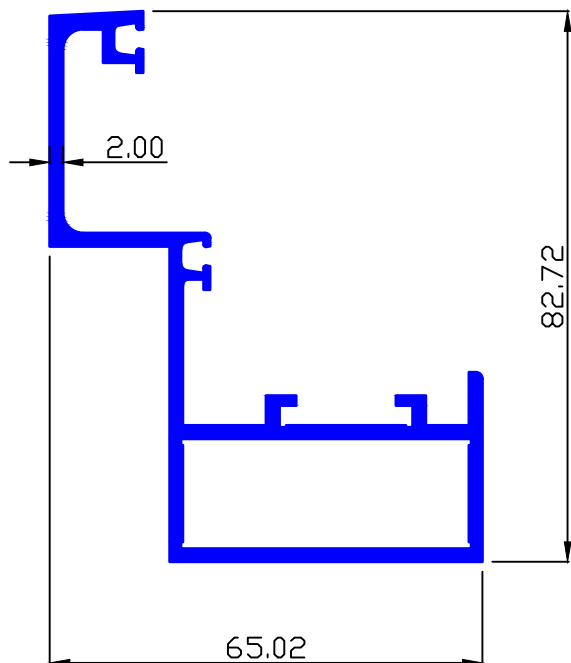

MAAN SEC.-89307

0.580 Kg/Mtr.

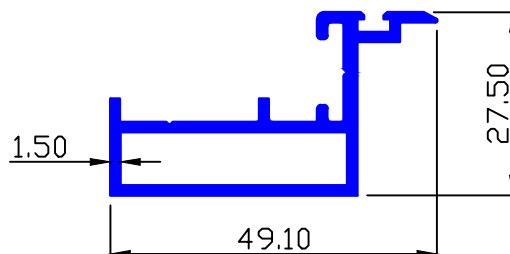

MAAN SEC.-89322

0.580 Kg/Mtr.

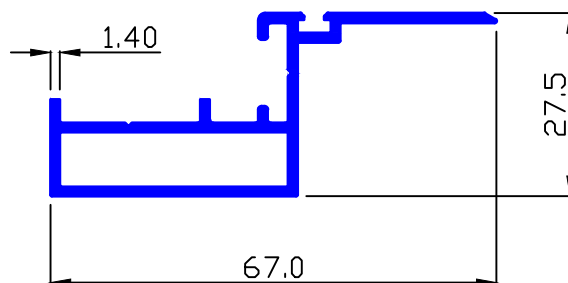

MAAN SEC.-89350

1.506 Kg/Mtr.

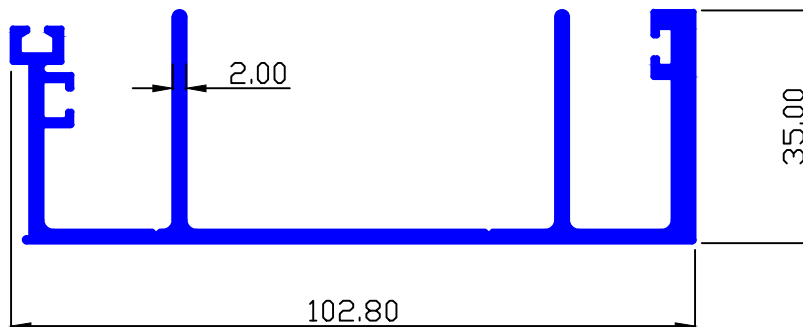



STRUCTURE GLAZING

MAAN SEC.-89351

1.407 Kg/Mtr.

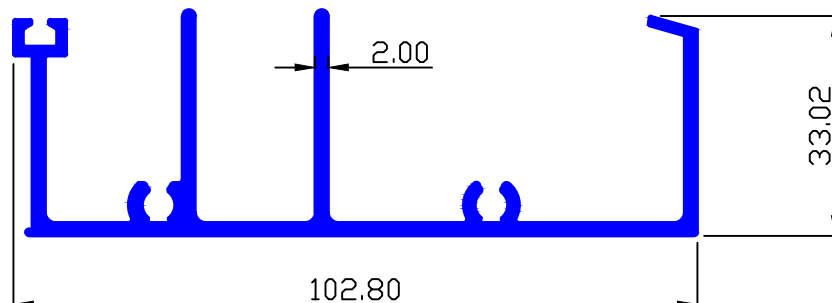

MAAN SEC.-89352

1.898 Kg/Mtr.

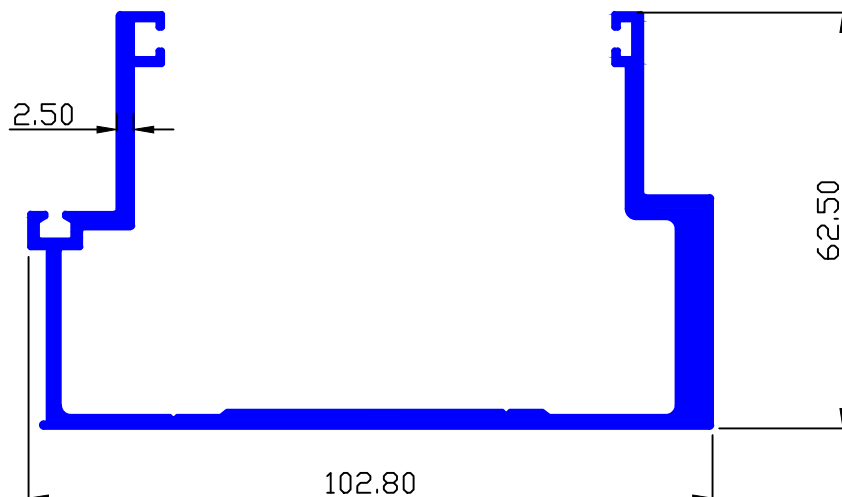

MAAN SEC.-89354

2.589 Kg/Mtr.

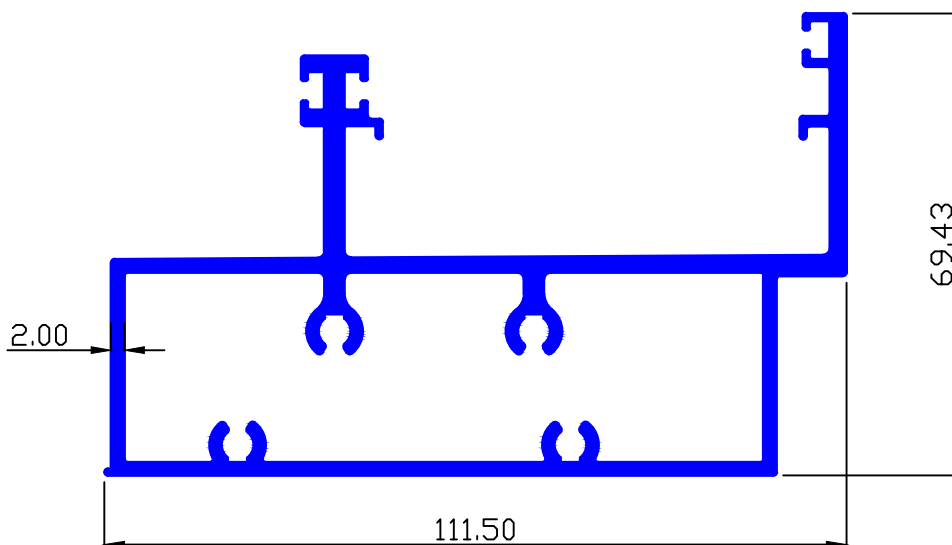



MAAN ALUMINIUM LTD.

STGL-016

STRUCTURE GLAZING

MAAN SEC.-89381

0.811 Kg/Mtr.

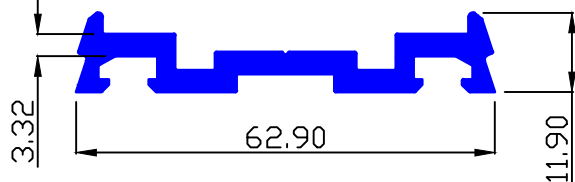

MAAN SEC.-89382

0.755 Kg/Mtr.

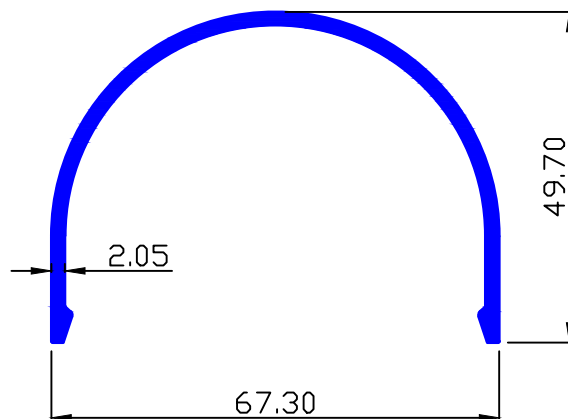

MAAN SEC.-89384

1.071 Kg/Mtr.

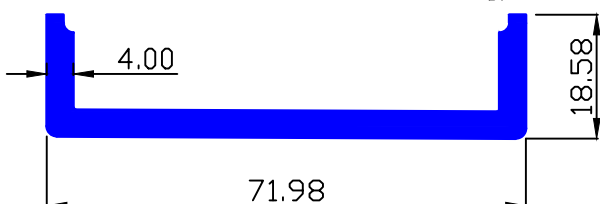

MAAN SEC.-89385

2.212 Kg/Mtr.

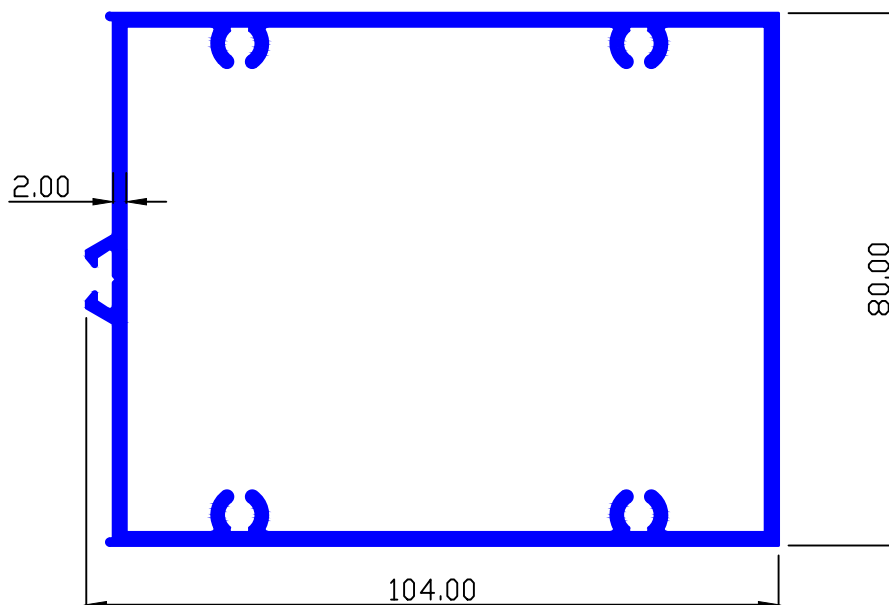

MAAN SEC.-89390

0.856 Kg/Mtr.

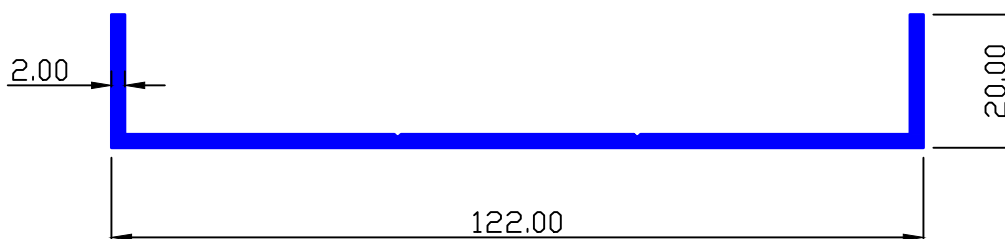



STRUCTURE GLAZING

MAAN SEC.-89488 0.397 Kg/Mtr.

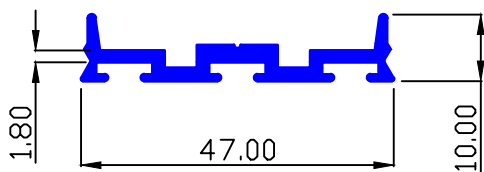

MAAN SEC.-89489 0.315 Kg/Mtr.

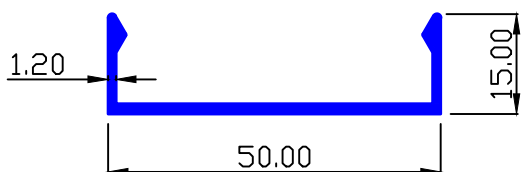

MAAN SEC.-89493 0.323 Kg/Mtr.

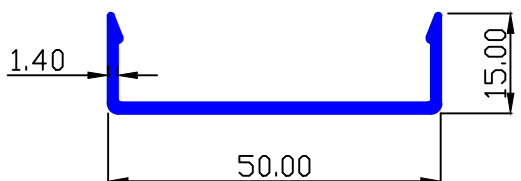

MAAN SEC.-89494 0.413 Kg/Mtr.

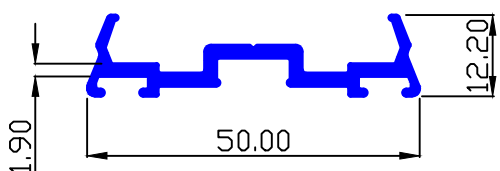

MAAN SEC.-89498 0.331 Kg/Mtr.

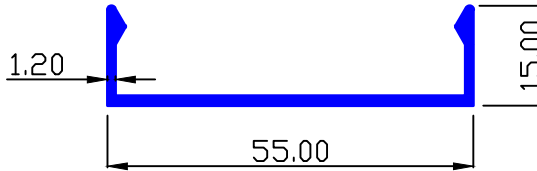

MAAN SEC.-89499 0.602 Kg/Mtr.

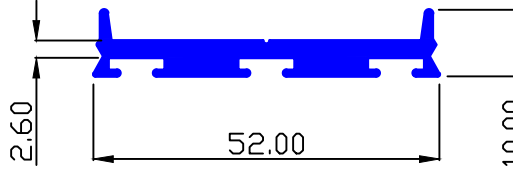

MAAN SEC.-89513 0.920 Kg/Mtr.

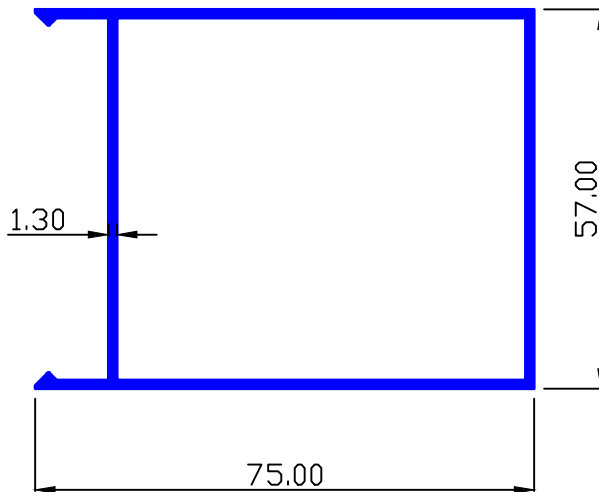

MAAN SEC.-89555 1.600 Kg/Mtr.

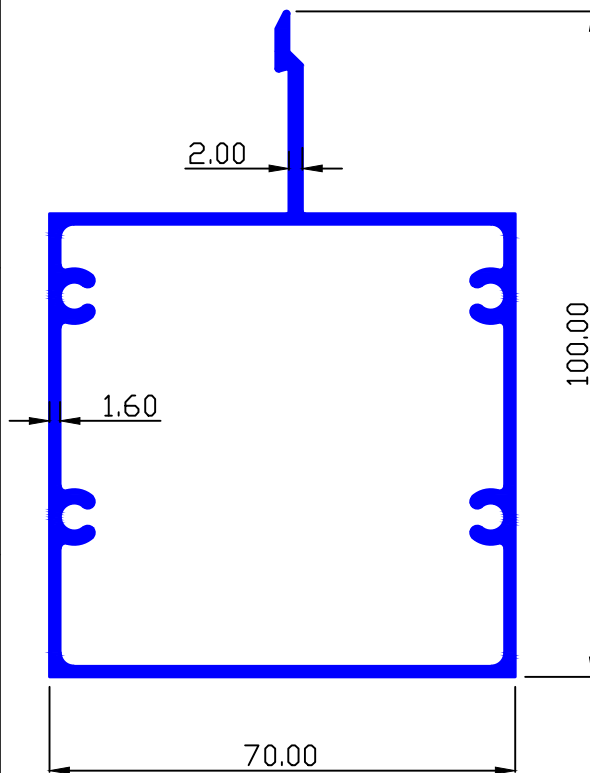



STRUCTURE GLAZING

MAAN SEC.-89556

1.615 Kg/Mtr.

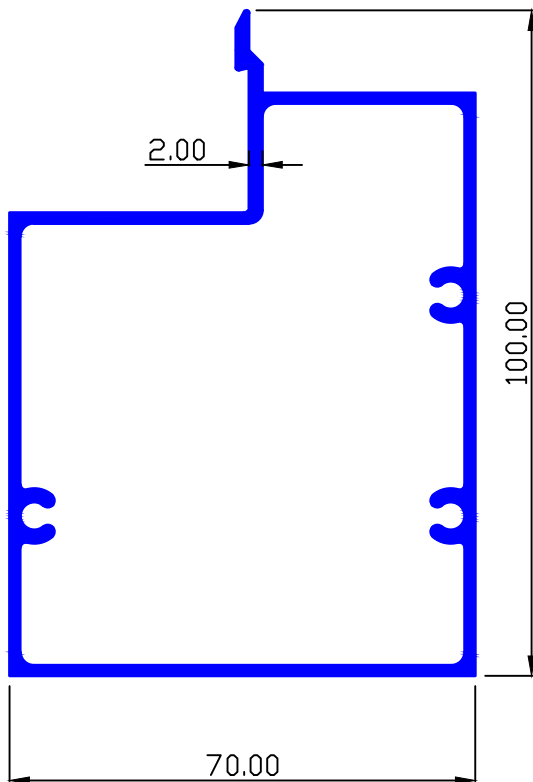

MAAN SEC.-89571

0.343 Kg/Mtr.

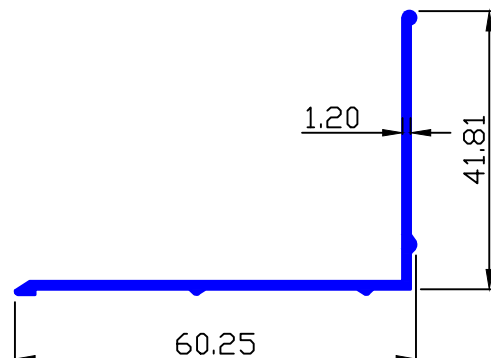

MAAN SEC.-89573

0.976 Kg/Mtr.

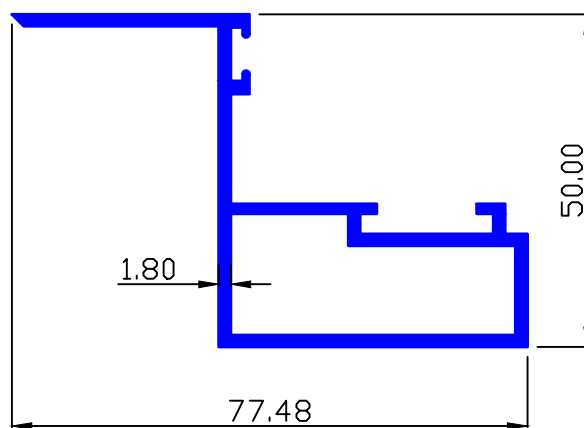

MAAN SEC.-89572

1.229 Kg/Mtr.

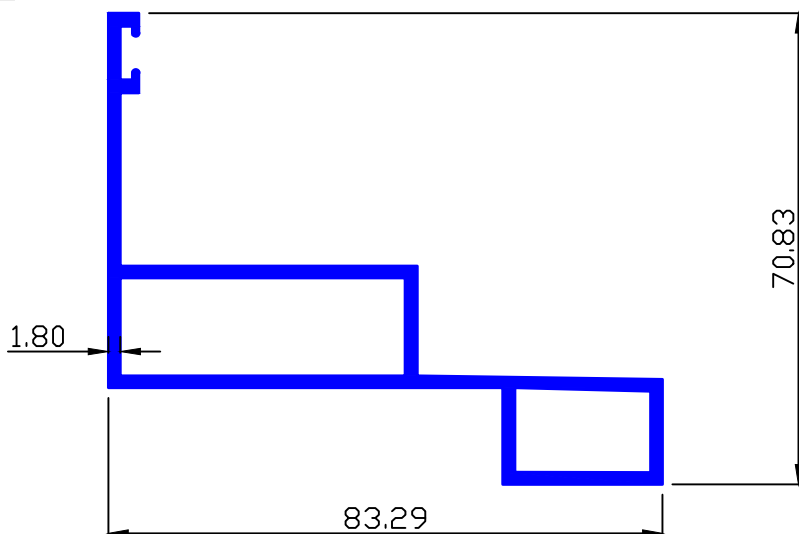



STRUCTURE GLAZING

MAAN SEC.-6841 0.443 Kg/Mtr.

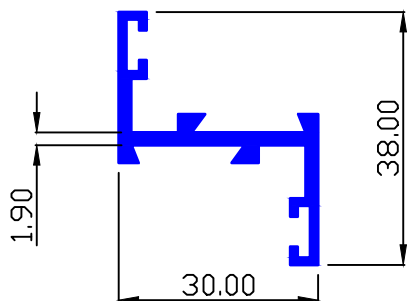

MAAN SEC.-7014 1.067 Kg/Mtr.

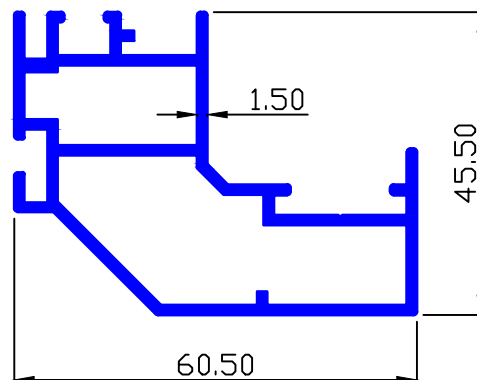

MAAN SEC.-6843 0.859 Kg/Mtr.

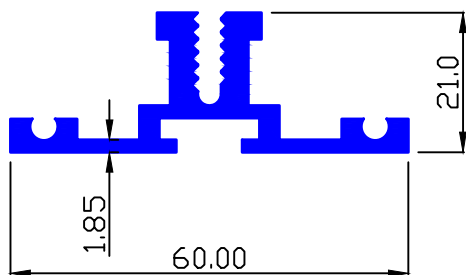

MAAN SEC.-7078 2.241 Kg/Mtr.

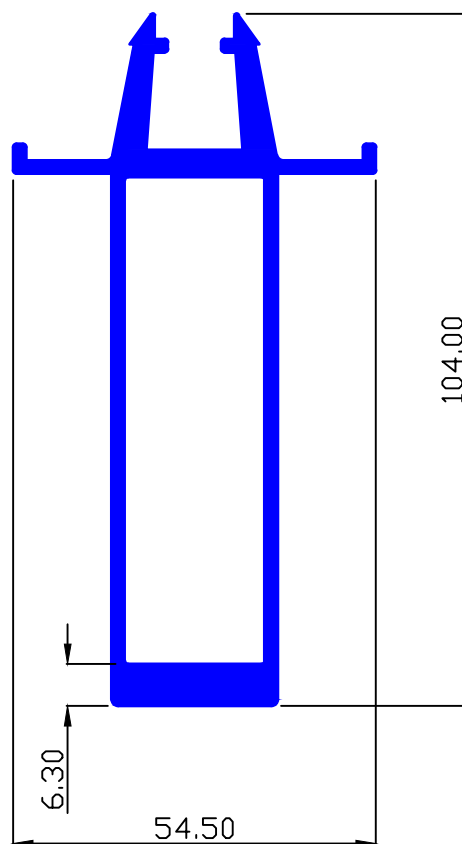

MAAN SEC.-6844 0.520 Kg/Mtr.

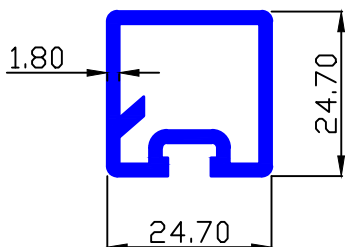

MAAN SEC.-7013 1.179 Kg/Mtr.

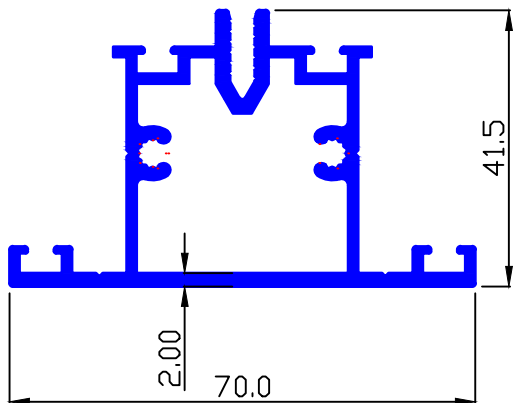



STRUCTURE GLAZING

MAAN SEC.-7079

0.846 Kg/Mtr.

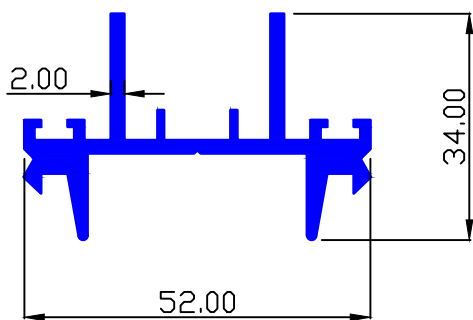

MAAN SEC.-8054

0.320 Kg/Mtr.

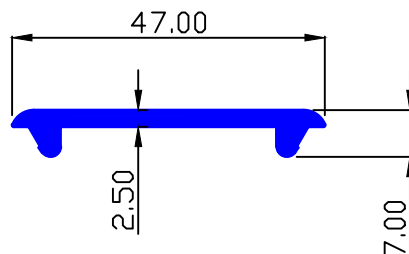

MAAN SEC.-7080

0.335 Kg/Mtr.

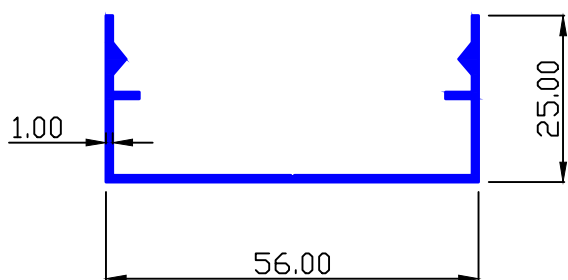

MAAN SEC.-8083

0.480 Kg/Mtr.

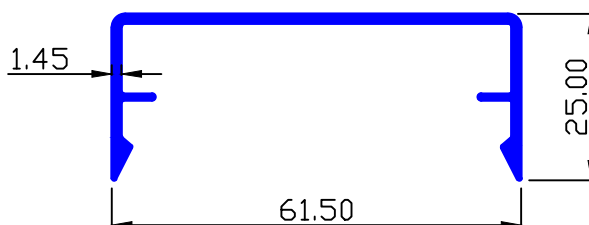

MAAN SEC.-7099

0.687 Kg/Mtr.

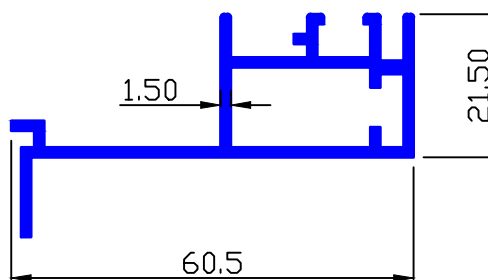

MAAN SEC.-8510

0.556 Kg/Mtr.

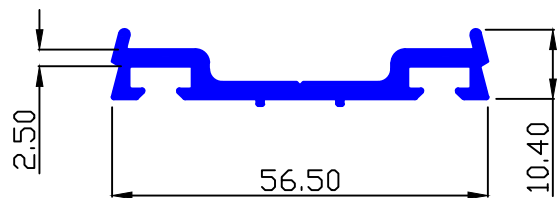

MAAN SEC.-8044

0.410 Kg/Mtr.

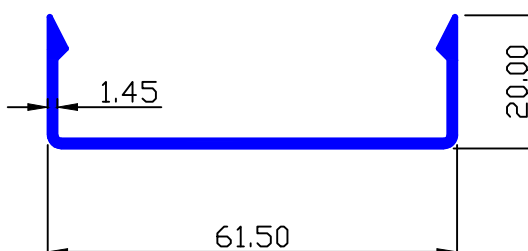

MAAN SEC.-8511

0.348 Kg/Mtr.

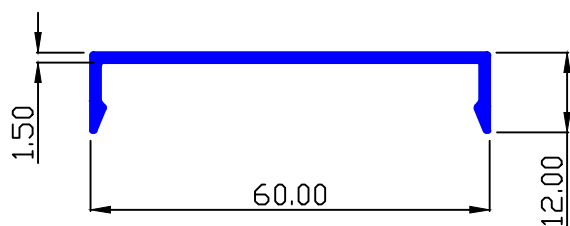

MAAN SEC.-89646

0.517 Kg/Mtr.

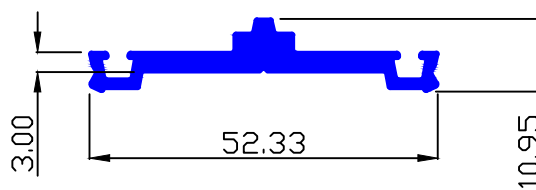



STRUCTURAL GLAZING

MAAN SEC.-90357

0.466 Kg/Mtr.

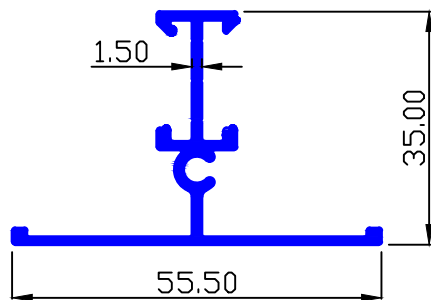

MAAN SEC.-90215

1.043 Kg/Mtr.

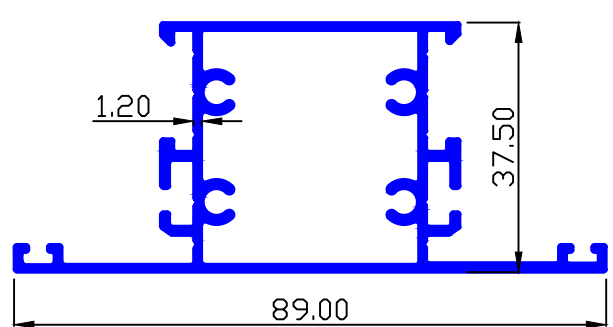

MAAN SEC.-90216

0.451 Kg/Mtr.

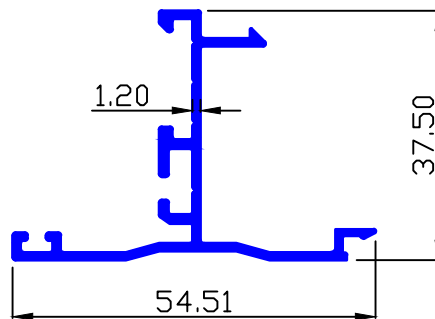

MAAN SEC.-90214

0.852 Kg/Mtr.

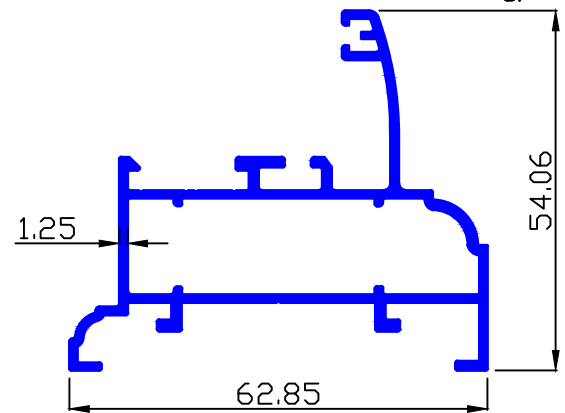

MAAN SEC.-90333

2.234 Kg/Mtr.

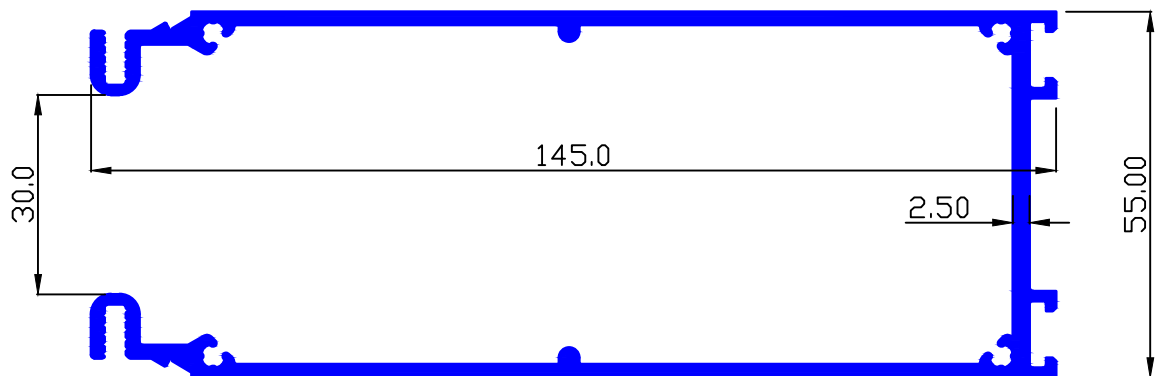



STRUCTURAL GLAZING

MAAN SEC.-90224

0.563 Kg/Mtr.

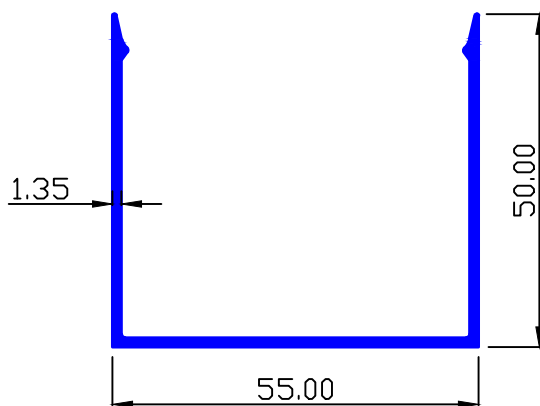

MAAN SEC.-90208

0.480 Kg/Mtr.

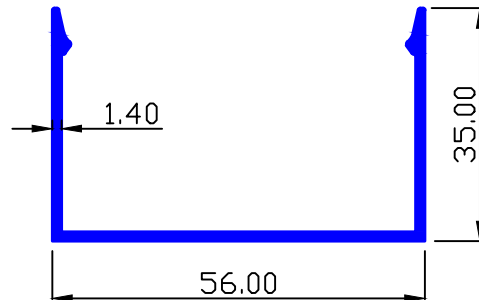

MAAN SEC.-90225

0.797 Kg/Mtr.

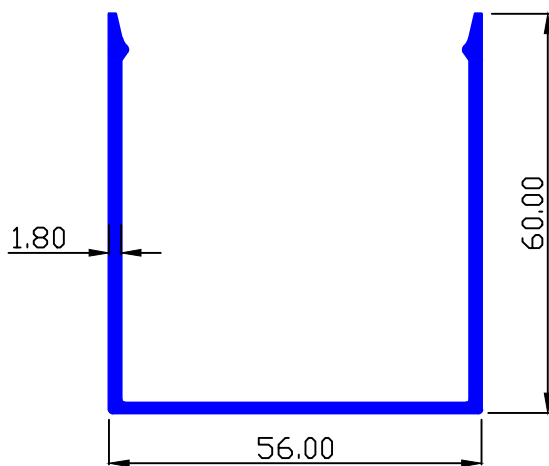

MAAN SEC.-90207

0.413 Kg/Mtr.

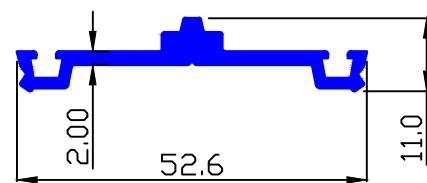

MAAN SEC.-90332

0.408 Kg/Mtr.

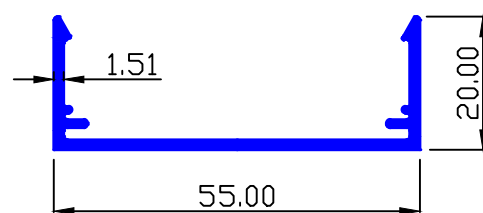

MAAN SEC.-90226

0.588 Kg/Mtr.

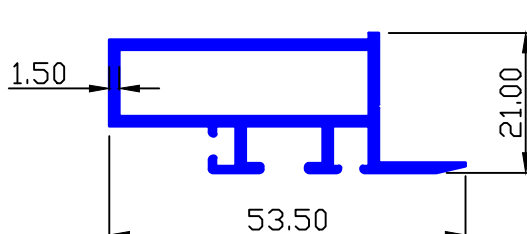

MAAN SEC.-89647

0.281 Kg/Mtr.

