

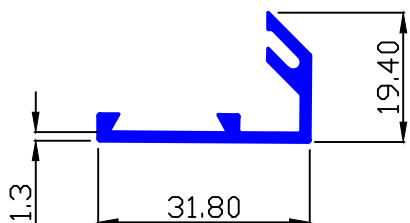

ARCHITECTURAL SECTION

**MAAN SEC.-6845**

0.244 Kg/Mtr.



**MAAN SEC.-7062**

0.637 Kg/Mtr.

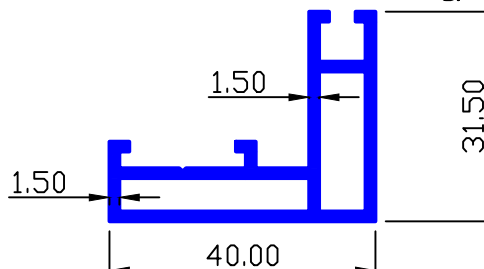

**MAAN SEC.-7011**

0.244 Kg/Mtr.

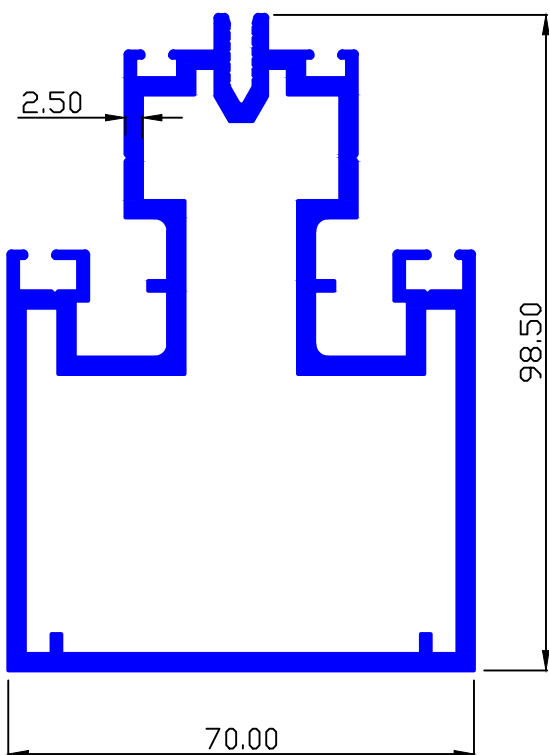

**MAAN SEC.-7064**

1.253 Kg/Mtr.

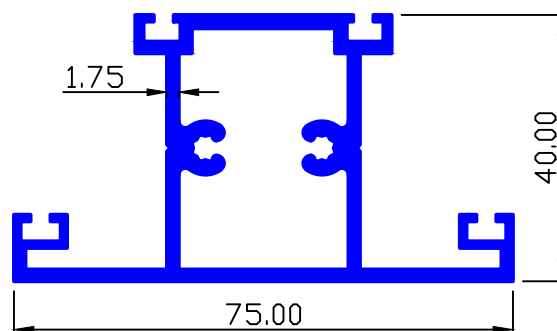

**MAAN SEC.-7065**

1.330 Kg/Mtr.

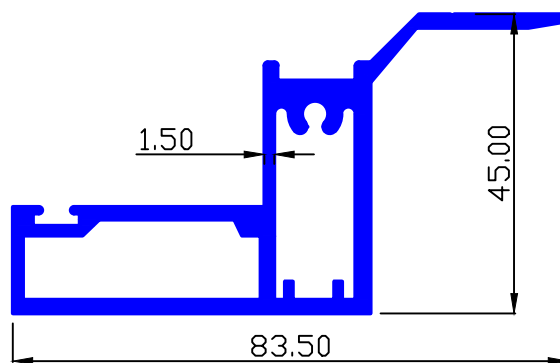

**MAAN SEC.-7027**

0.640 Kg/Mtr.

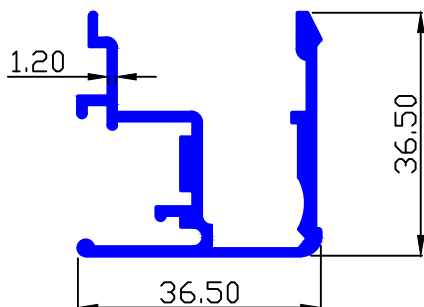

**MAAN SEC.-7711**

0.729 Kg/Mtr.

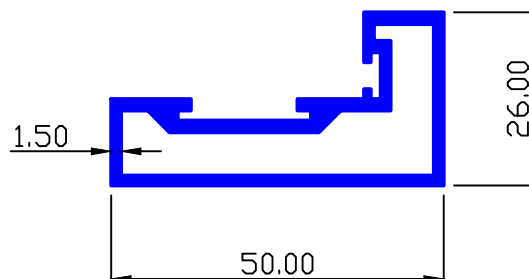



ARCHITECTURAL SECTION

MAAN SEC.-7630

1.408 Kg/Mtr.

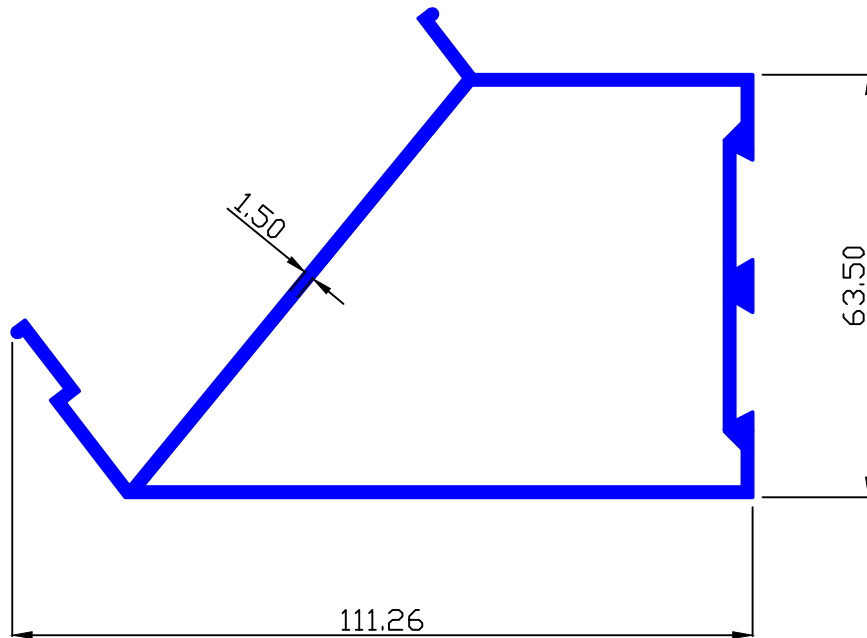

MAAN SEC.-7651

1.274 Kg/Mtr.

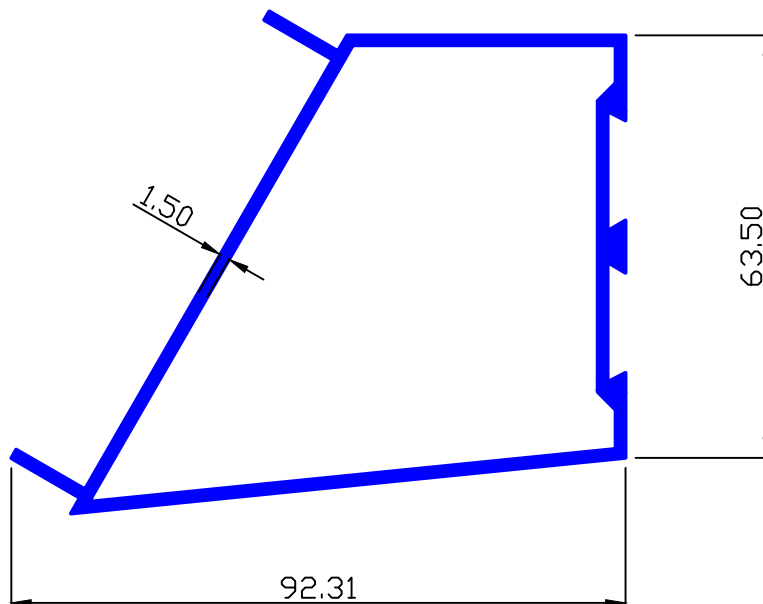



ARCHITECTURAL SECTION

MAAN SEC.-7720

0.646 Kg/Mtr.

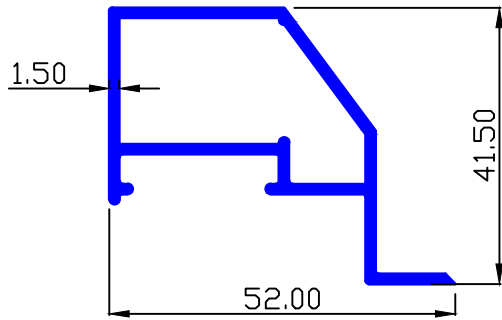

MAAN SEC.-7740

0.790 Kg/Mtr.

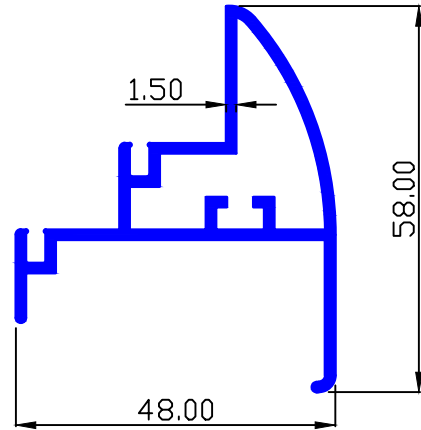

MAAN SEC.-7721

1.080 Kg/Mtr.

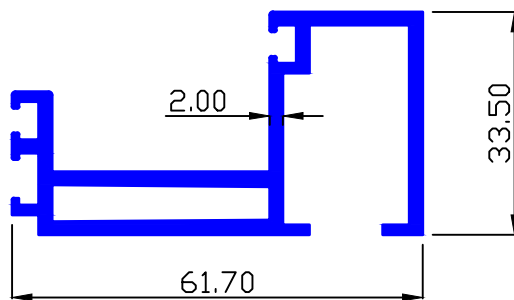

MAAN SEC.-7742

0.565 Kg/Mtr.

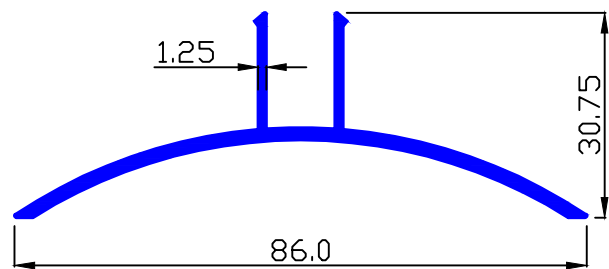

MAAN SEC.-7733

0.354 Kg/Mtr.

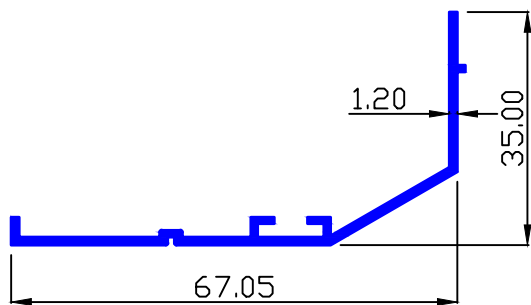

MAAN SEC.-7746

0.146 Kg/Mtr.

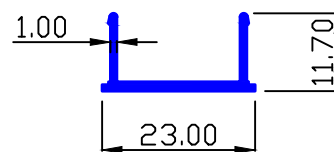

MAAN SEC.-7741

0.565 Kg/Mtr.

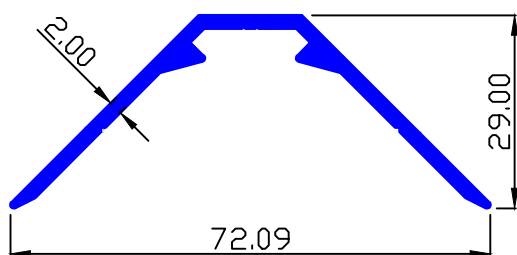

MAAN SEC.-7747

1.202 Kg/Mtr.

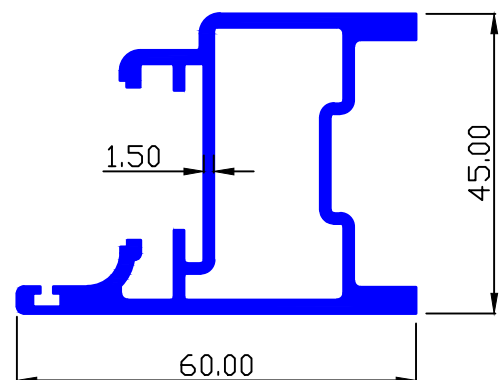



ARCHITECTURAL SECTION

MAAN SEC.-7748

1.314 Kg/Mtr.

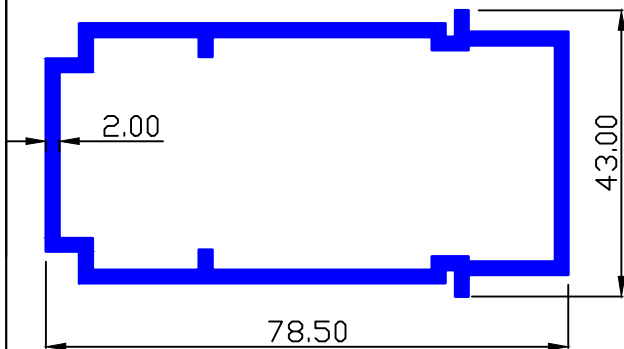

MAAN SEC.-7861

0.819 Kg/Mtr.

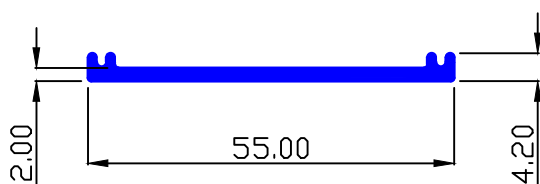

MAAN SEC.-7749

1.314 Kg/Mtr.

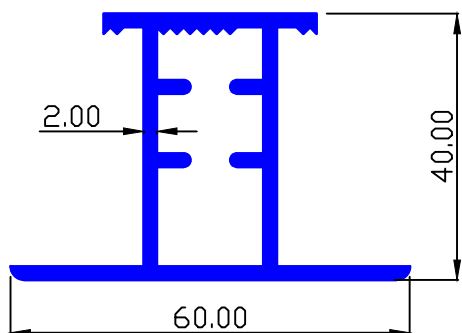

MAAN SEC.-7922

0.819 Kg/Mtr.

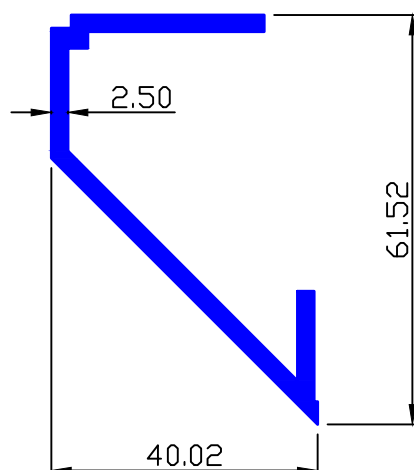

MAAN SEC.-8094

0.645 Kg/Mtr.

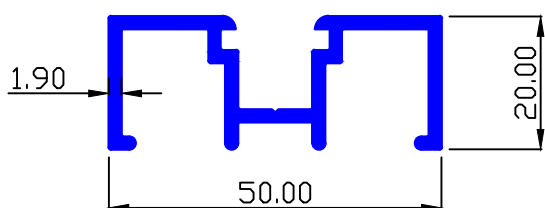

MAAN SEC.-7946

1.005 Kg/Mtr.

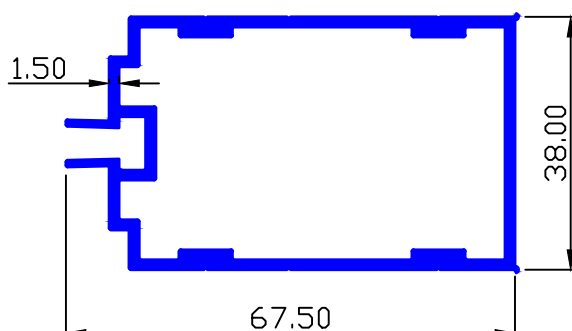

MAAN SEC.-8096

0.411 Kg/Mtr.

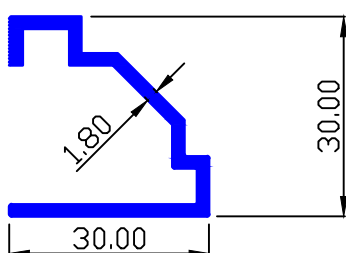

MAAN SEC.-7959

0.522 Kg/Mtr.

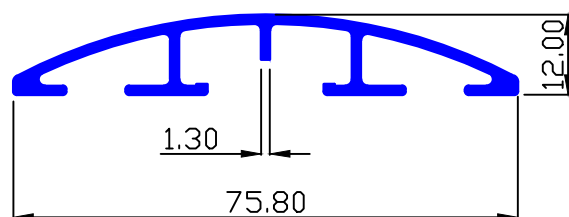



ARCHITECTURAL SECTION

MAAN SEC.-8057

1.343 Kg/Mtr.

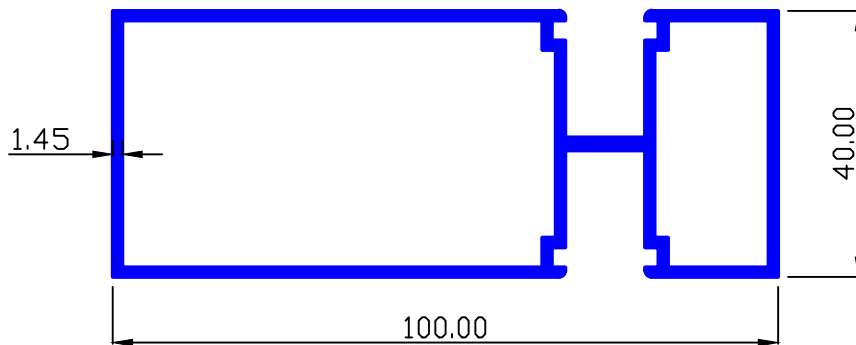

MAAN SEC.-8109

0.559 Kg/Mtr.

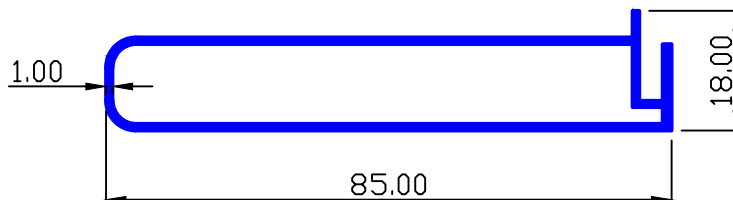

MAAN SEC.-8110

0.636 Kg/Mtr.

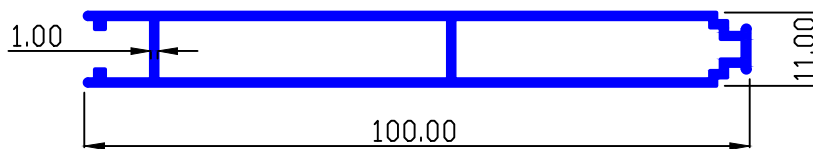

MAAN SEC.-8111

0.313 Kg/Mtr.

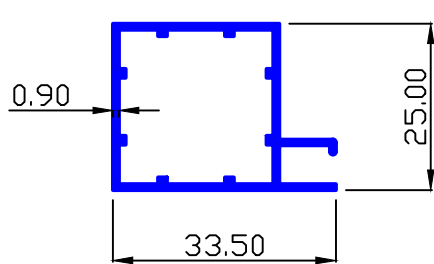

MAAN SEC.-8112

0.357 Kg/Mtr.

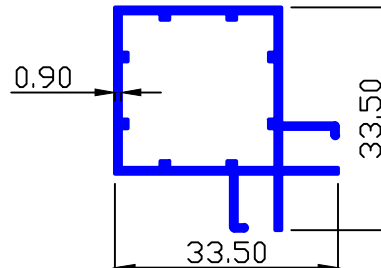

MAAN SEC.-8113

0.458 Kg/Mtr.

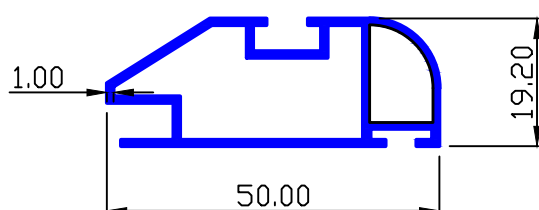

MAAN SEC.-8115

0.357 Kg/Mtr.

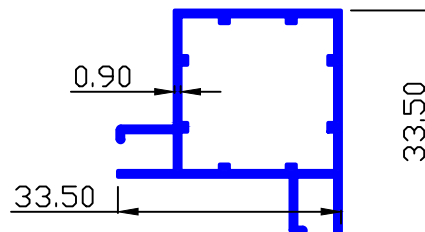



ARCHITECTURAL SECTION

MAAN SEC.-8117

0.732 Kg/Mtr.

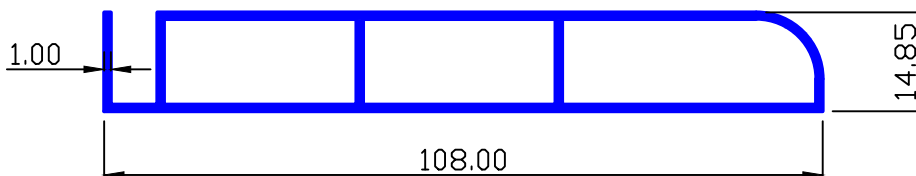

MAAN SEC.-8547

1.826 Kg/Mtr.

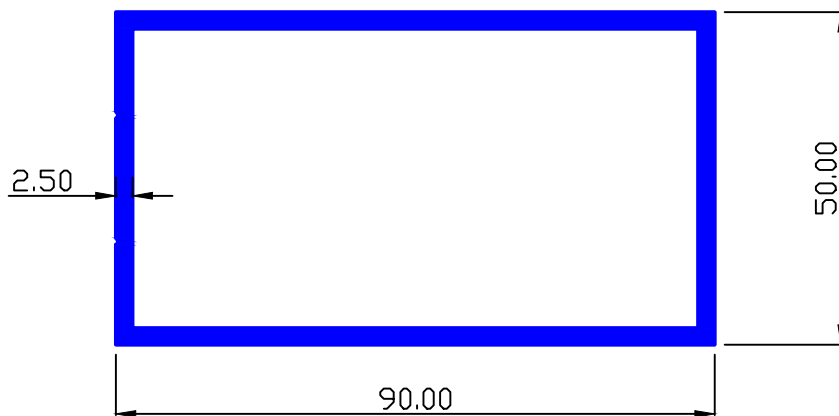

MAAN SEC.-8548

2.258 Kg/Mtr.

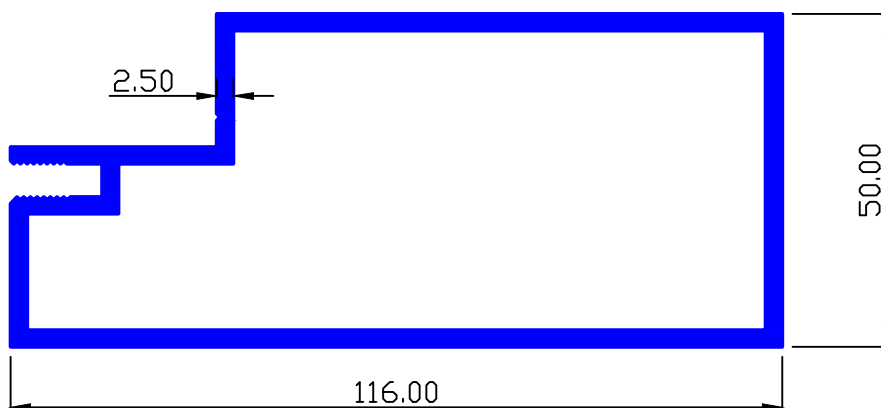

MAAN SEC.-8600

0.353 Kg/Mtr.

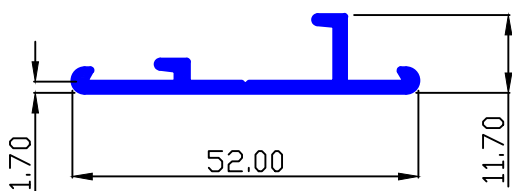

MAAN SEC.-8615

0.143 Kg/Mtr.

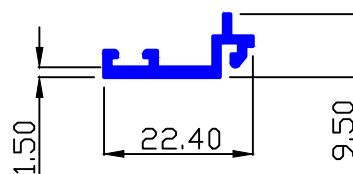



ARCHITECTURAL SECTION

MAAN SEC.-8622

0.852 Kg/Mtr.

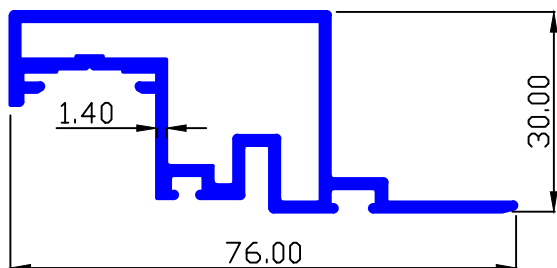

MAAN SEC.-8639

0.864 Kg/Mtr.

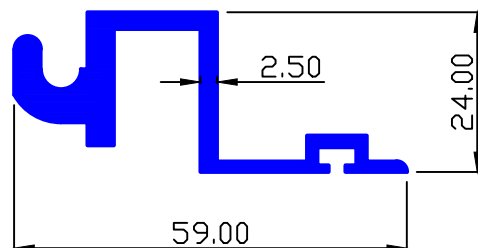

MAAN SEC.-8638

2.050 Kg/Mtr.

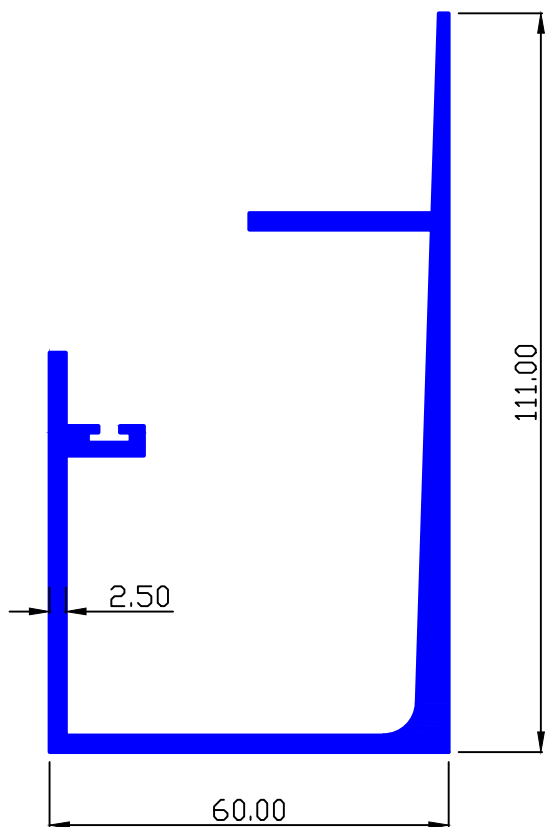

MAAN SEC.-8640

2.333 Kg/Mtr.

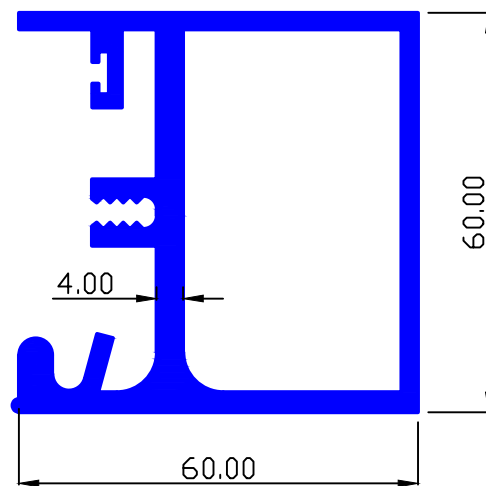

MAAN SEC.-8644

0.376 Kg/Mtr.

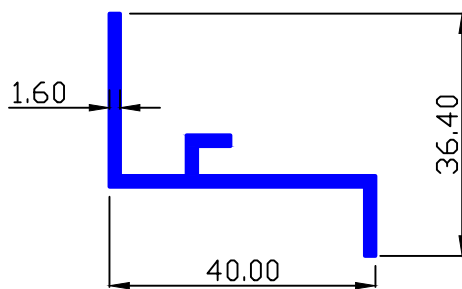

MAAN SEC.-8641

1.003 Kg/Mtr.

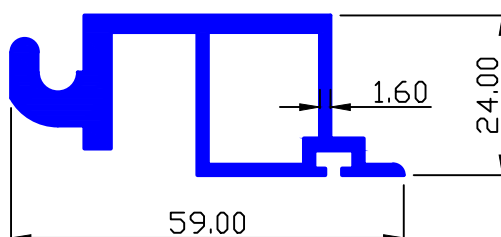

MAAN SEC.-8651

0.112 Kg/Mtr.

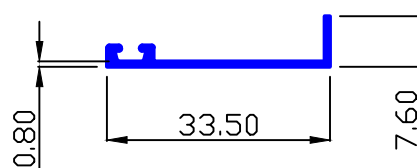



ARCHITECTURAL SECTION

MAAN SEC.-8652

0.388 Kg/Mtr.

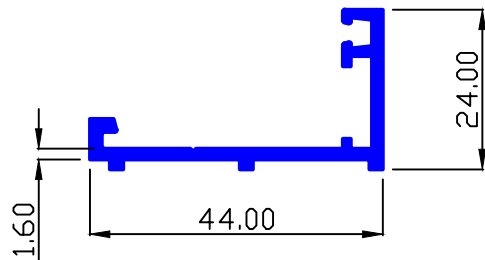

MAAN SEC.-8654

0.691 Kg/Mtr.

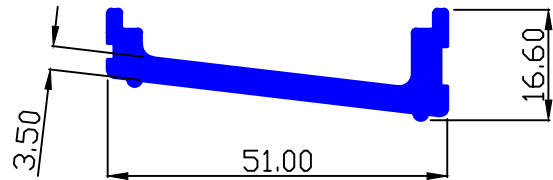

MAAN SEC.-8737

0.914 Kg/Mtr.

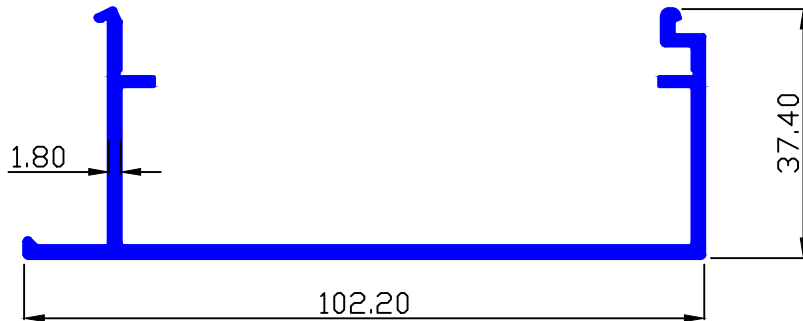

MAAN SEC.-8655

0.634 Kg/Mtr.

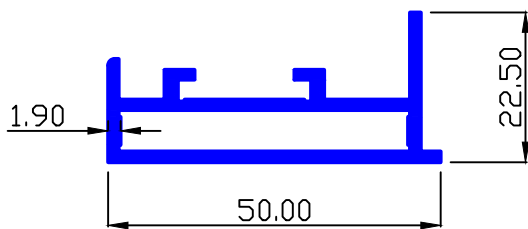

MAAN SEC.-8658

0.690 Kg/Mtr.

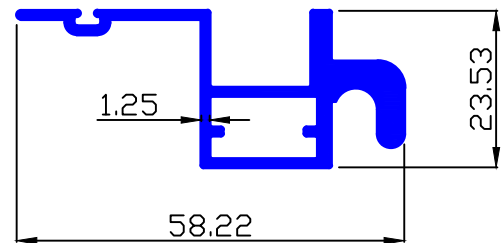

MAAN SEC.-8656

1.751 Kg/Mtr.

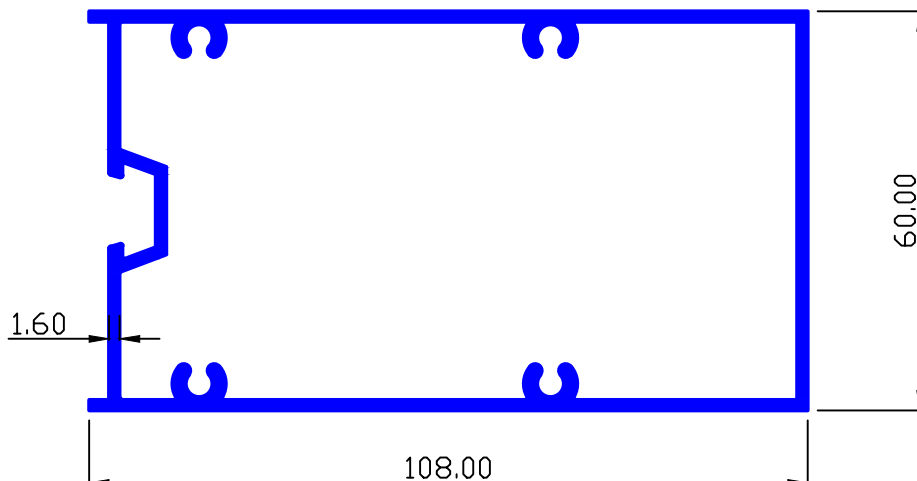



ARCHITECTURAL SECTION

MAAN SEC.-8657

1.918 Kg/Mtr.

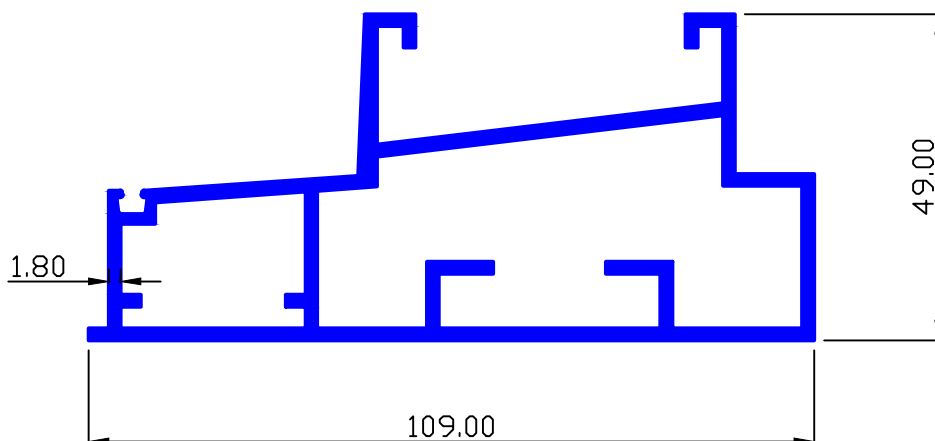

MAAN SEC.-8659

0.814 Kg/Mtr.

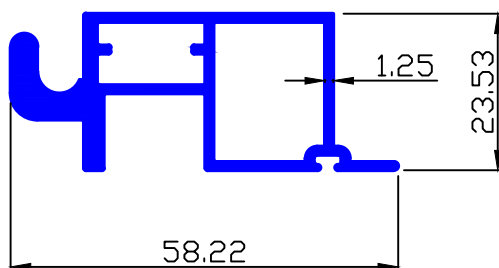

MAAN SEC.-8663

0.621 Kg/Mtr.

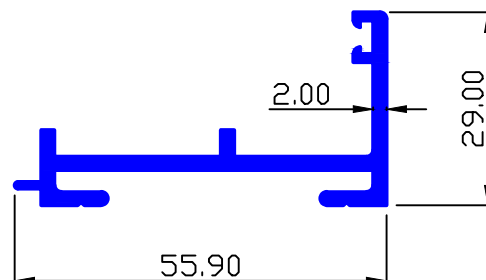

MAAN SEC.-8661

0.293 Kg/Mtr.

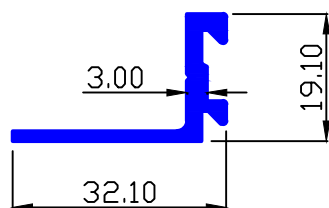

MAAN SEC.-8675

0.867 Kg/Mtr.

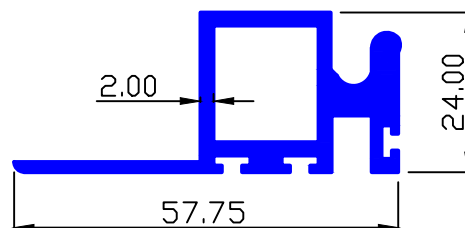

MAAN SEC.-8662

0.438 Kg/Mtr.

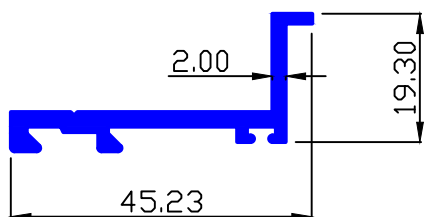

MAAN SEC.-8676

0.899 Kg/Mtr.

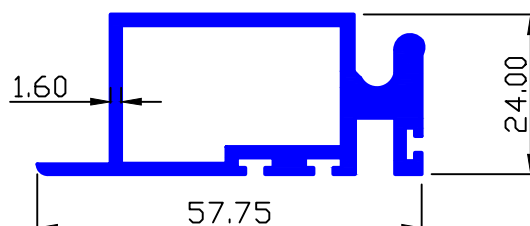



ARCHITECTURAL SECTION

MAAN SEC.-8685

1.772 Kg/Mtr.

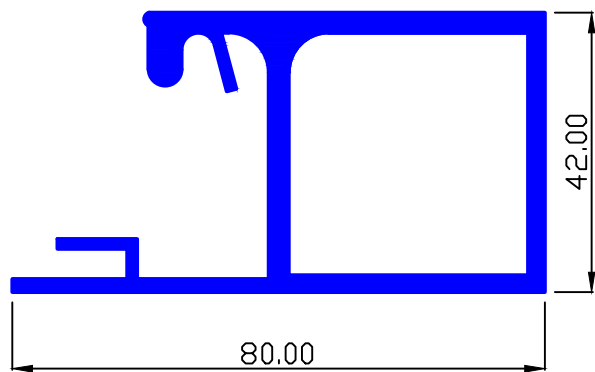

MAAN SEC.-8686

1.307 Kg/Mtr.

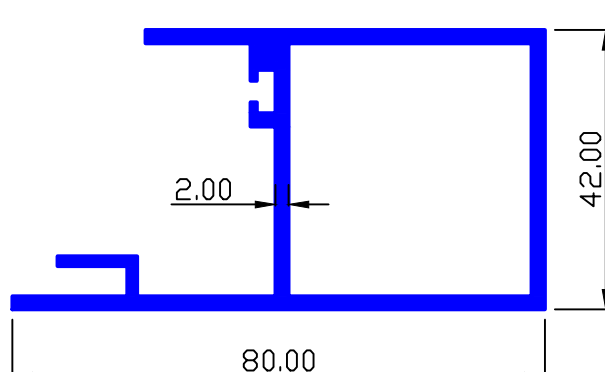

MAAN SEC.-8687

2.395 Kg/Mtr.

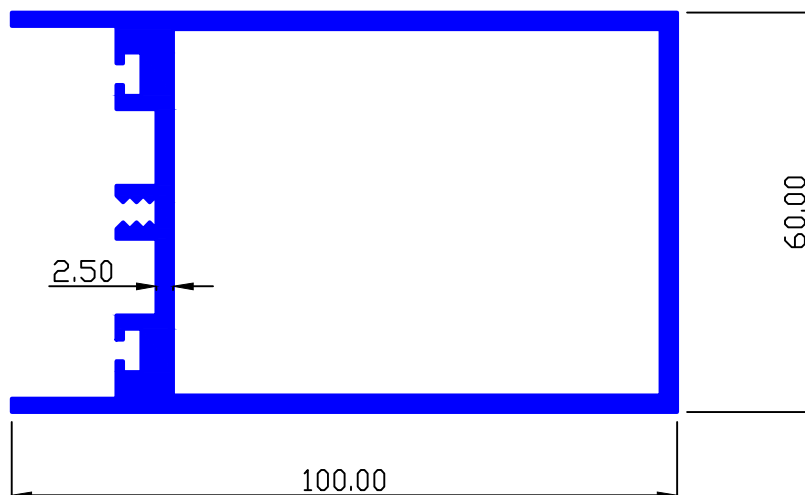

MAAN SEC.- 90764

1.757 Kg/Mtr.

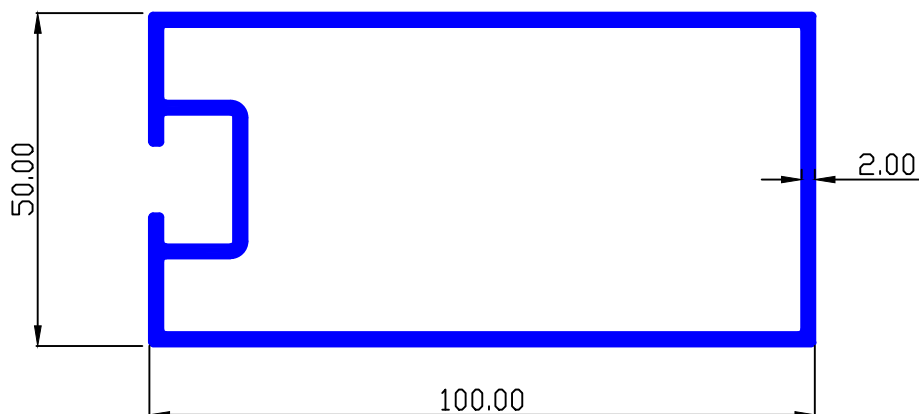



ARCHITECTURAL SECTION

MAAN SEC.-8689

0.870 Kg/Mtr.

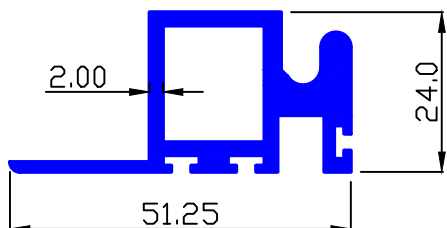

MAAN SEC.-8696

0.332 Kg/Mtr.

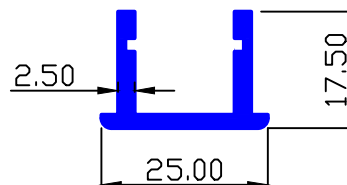

MAAN SEC.-8698

1.151 Kg/Mtr.

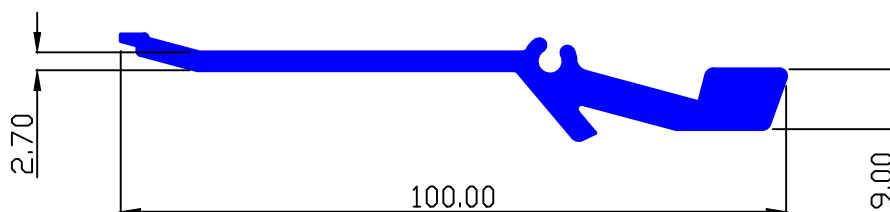

MAAN SEC.-8721

1.581 Kg/Mtr.

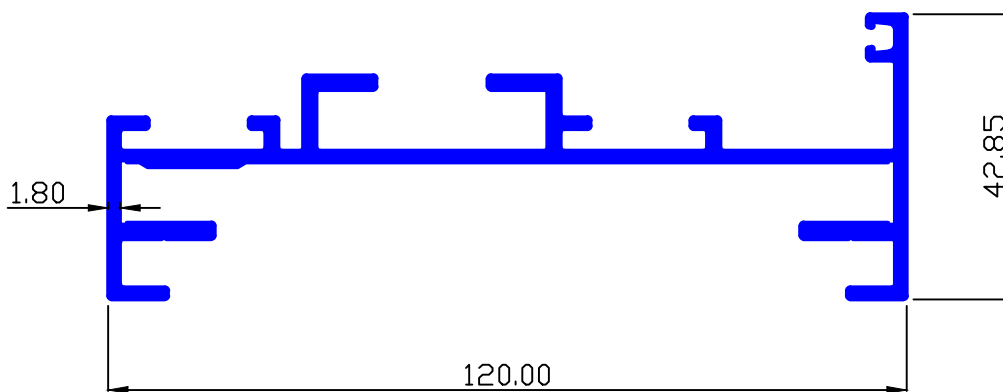

MAAN SEC.-8722

1.368 Kg/Mtr.

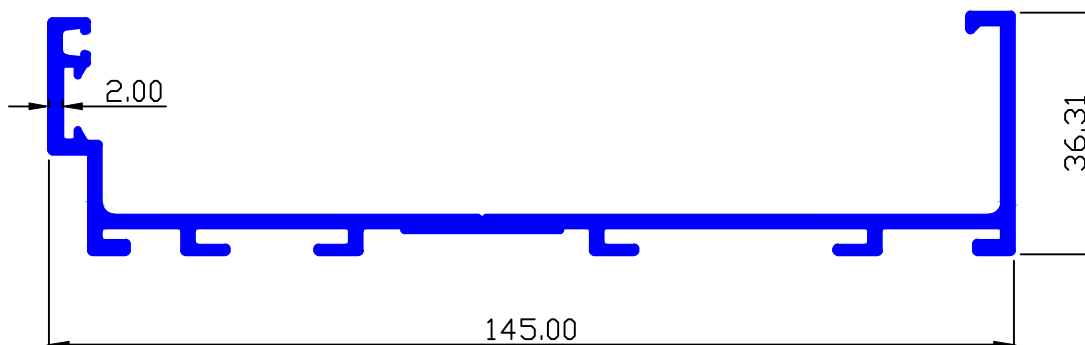



ARCHITECTURAL SECTION

MAAN SEC.-8086

1.045 Kg/Mtr.

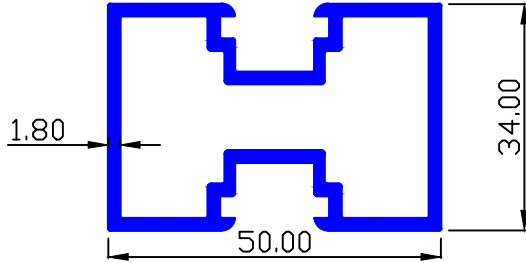

MAAN SEC.-8727

0.471 Kg/Mtr.

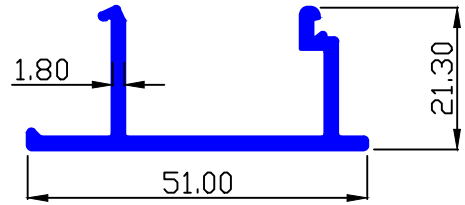

MAAN SEC.-8723

1.218 Kg/Mtr.

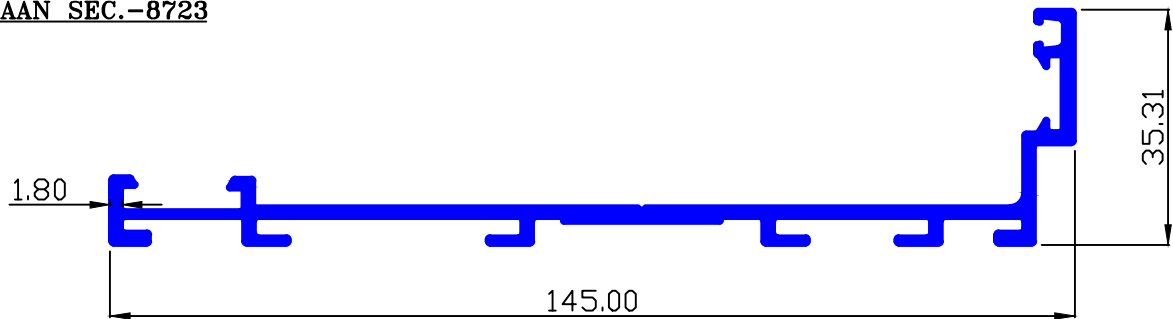

MAAN SEC.-8724

1.814 Kg/Mtr.

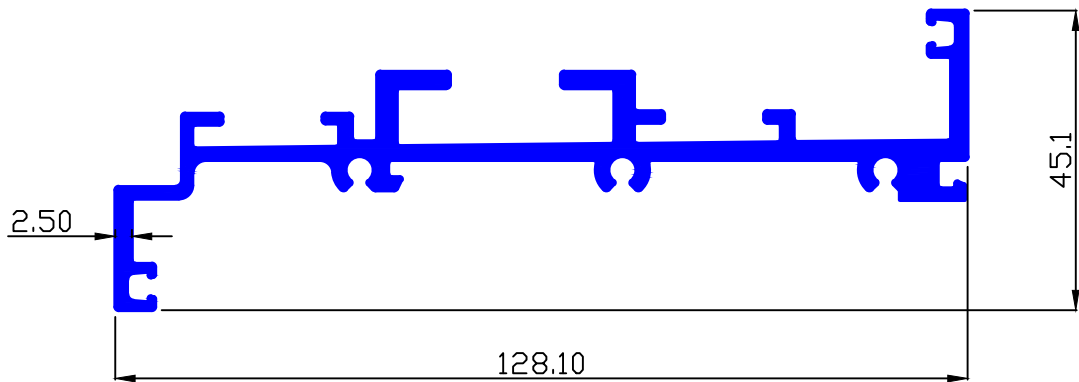

MAAN SEC.-8725

0.807 Kg/Mtr.

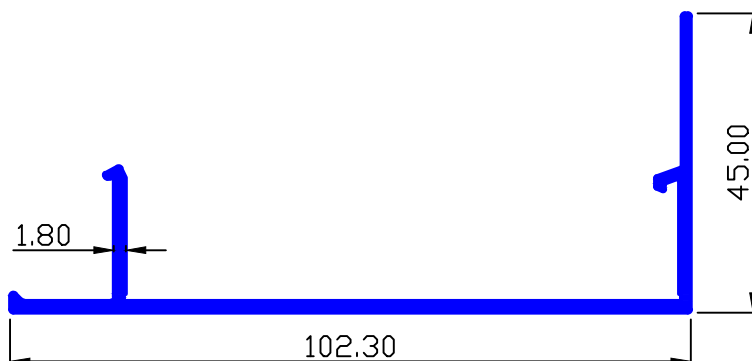

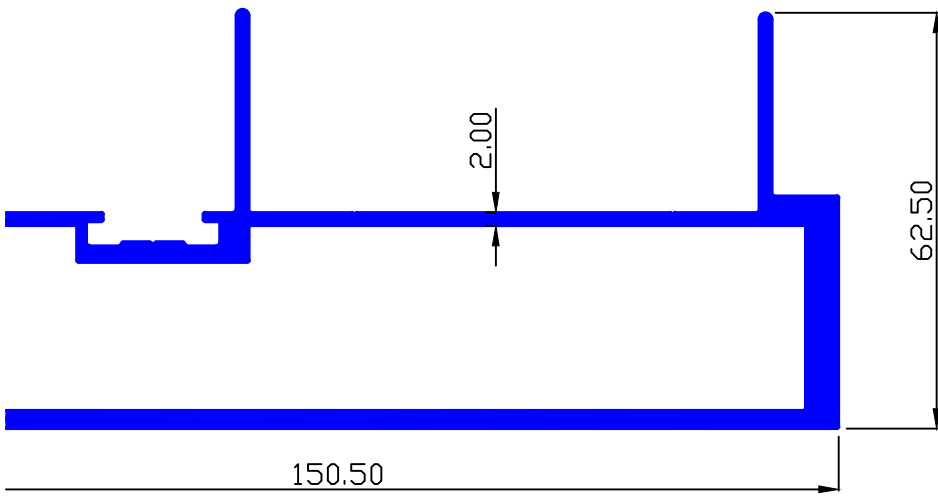

1.048 Kg/Mtr.

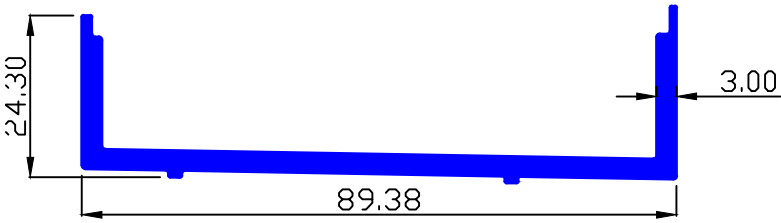

2.710 Kg/Mtr.

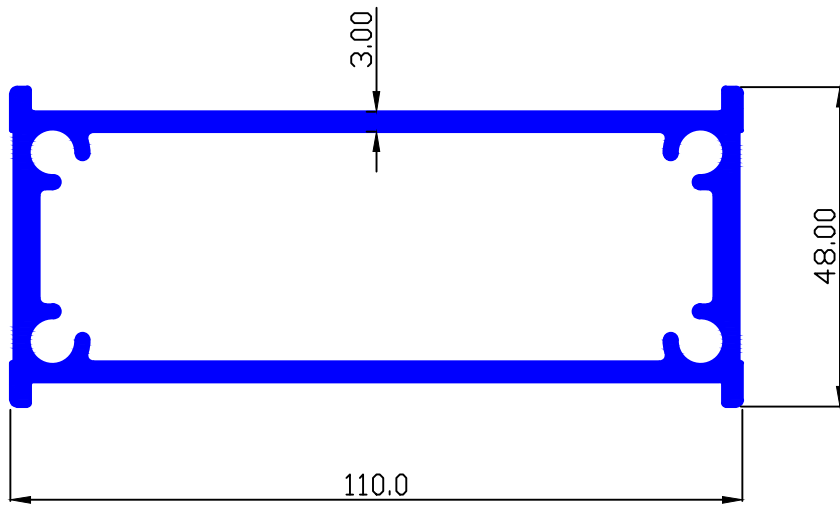



ARCHITECTURAL SECTION

MAAN SEC.-8688

1.614 Kg/Mtr.

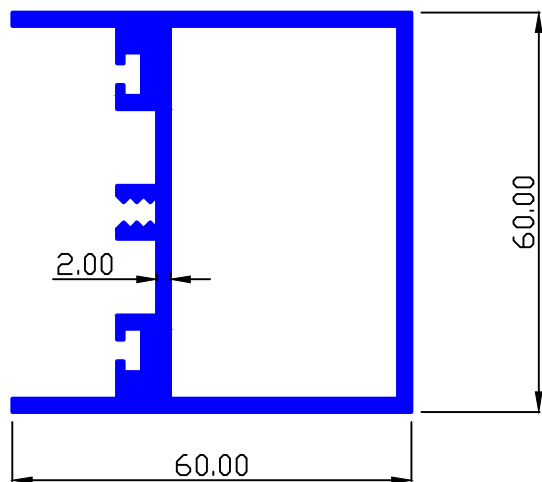

MAAN SEC.-8508

0.633 Kg/Mtr.

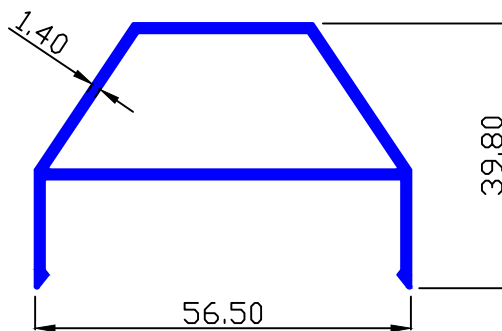

MAAN SEC.-8786

0.659 Kg/Mtr.

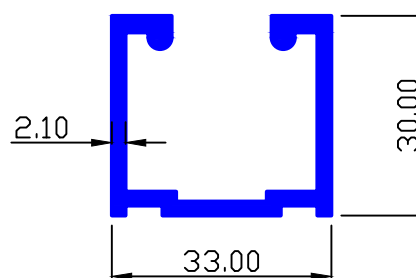

MAAN SEC.-8787

2.601 Kg/Mtr.

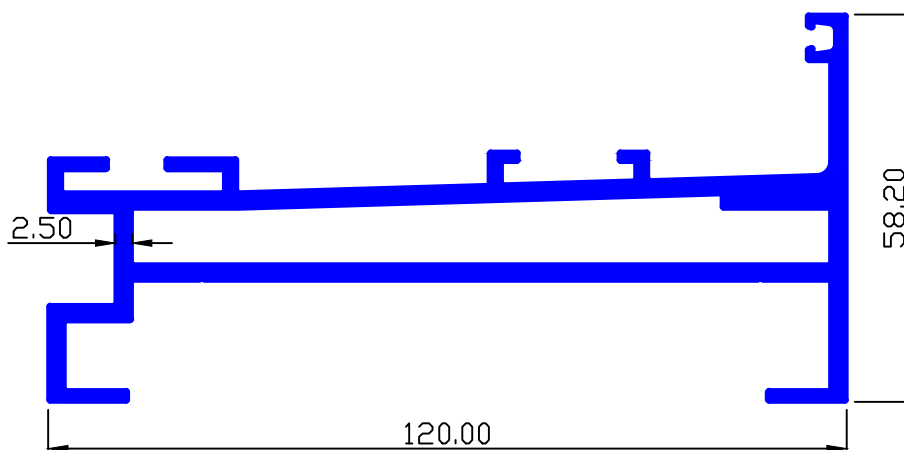

MAAN SEC.-8789

0.905 Kg/Mtr.

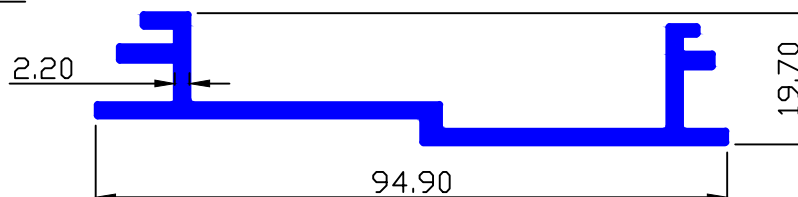



ARCHITECTURAL SECTION

MAAN SEC.-8788

0.571 Kg/Mtr.

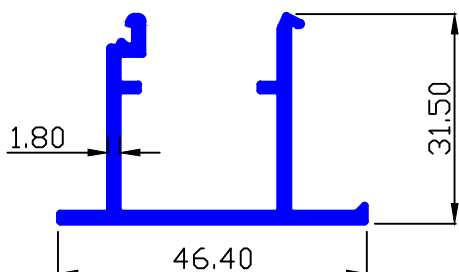

MAAN SEC.-8793

0.485 Kg/Mtr.

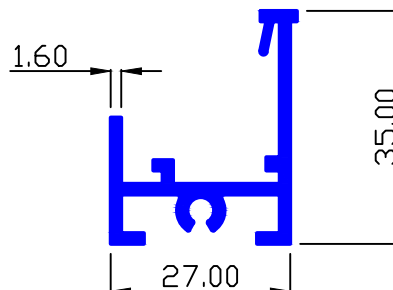

MAAN SEC.-8790

0.777 Kg/Mtr.

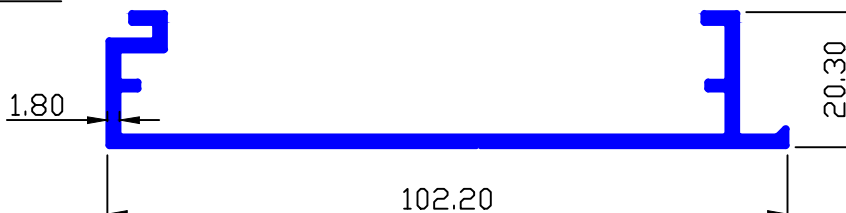

MAAN SEC.-8794

0.175 Kg/Mtr.

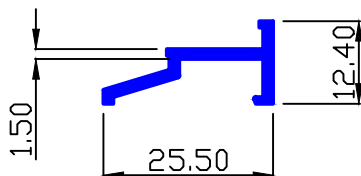

MAAN SEC.-8831

0.142 Kg/Mtr.

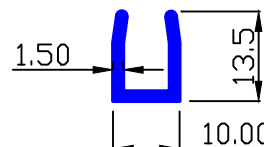

MAAN SEC.-8795

0.115 Kg/Mtr.

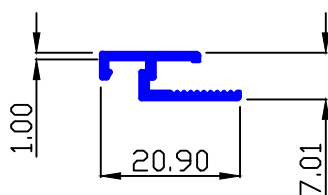

MAAN SEC.-8833

0.388 Kg/Mtr.

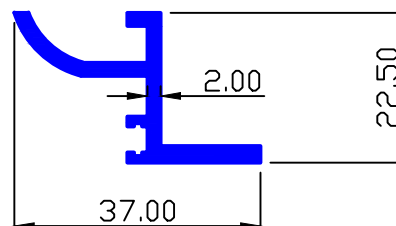

MAAN SEC.-8830

0.260 Kg/Mtr.

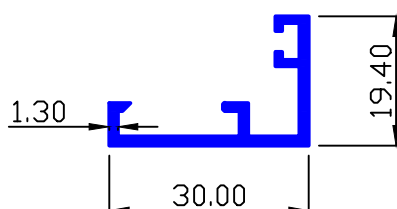

MAAN SEC.-8835

0.304 Kg/Mtr.

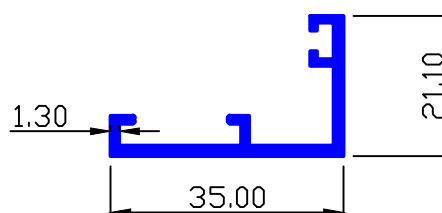



ARCHITECTURAL SECTION

MAAN SEC.-8837

0.747 Kg/Mtr.

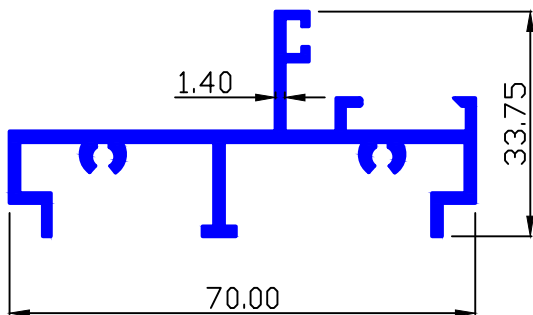

MAAN SEC.-8858

2.296 Kg/Mtr.

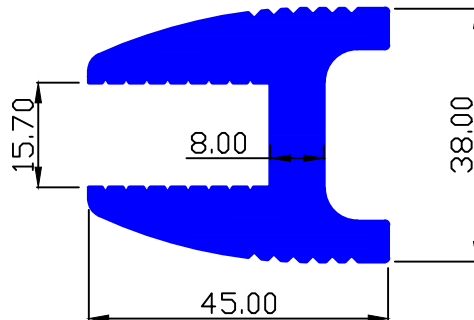

MAAN SEC.-8852

0.190 Kg/Mtr.

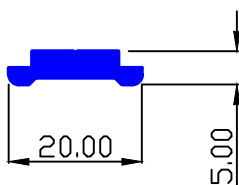

MAAN SEC.-8890

0.405 Kg/Mtr.

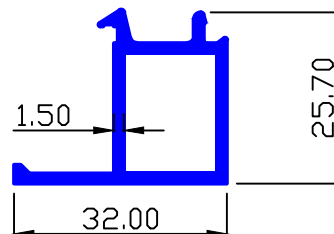

MAAN SEC.-8891

1.633 Kg/Mtr.

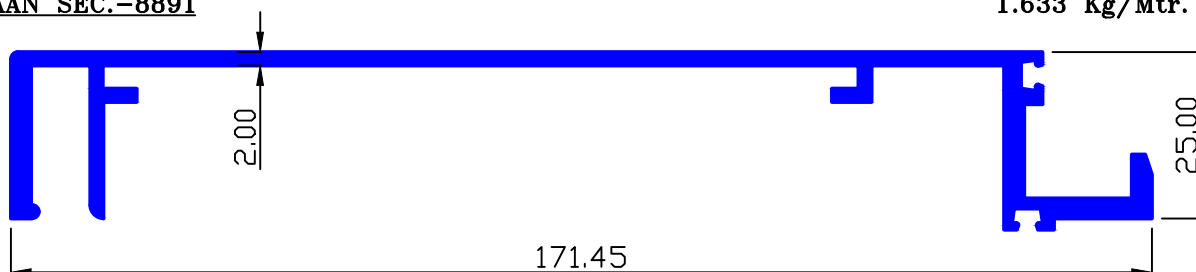

MAAN SEC.-8892

1.531 Kg/Mtr.

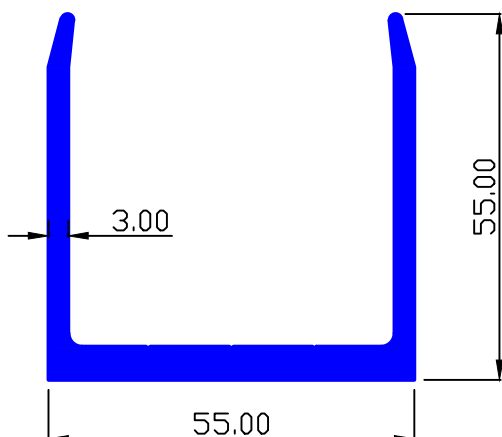

MAAN SEC.-8893

0.181 Kg/Mtr.

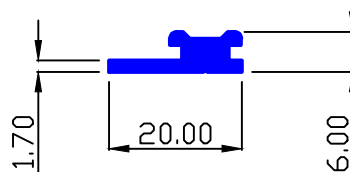

MAAN SEC.-8894

0.324 Kg/Mtr.

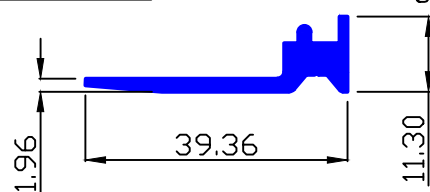



ARCHITECTURAL SECTION

MAAN SEC.-8895

2.289 Kg/Mtr.

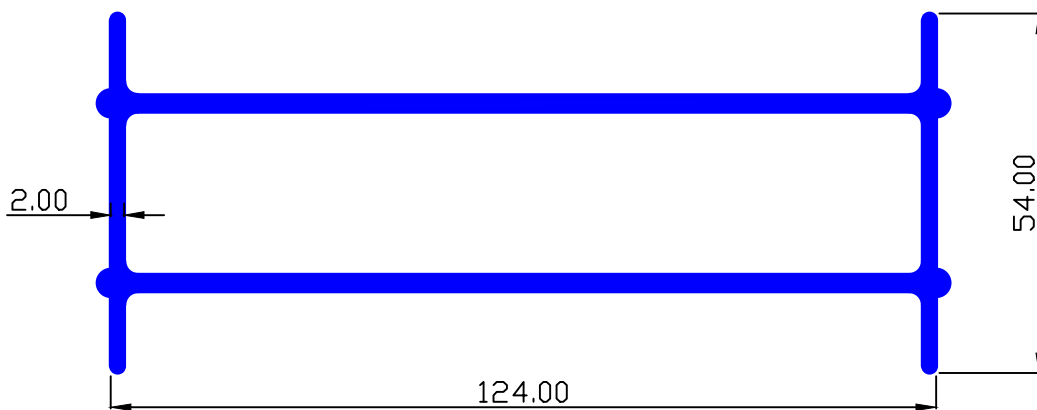

MAAN SEC.-8904

0.731 Kg/Mtr.

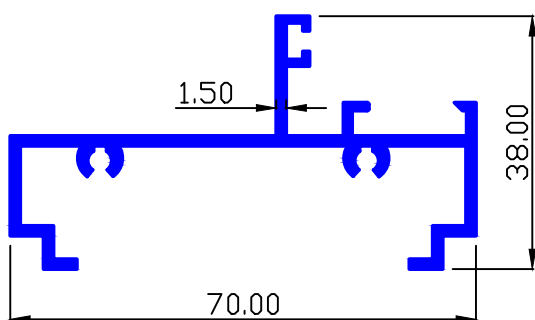

MAAN SEC.-8959

0.417 Kg/Mtr.

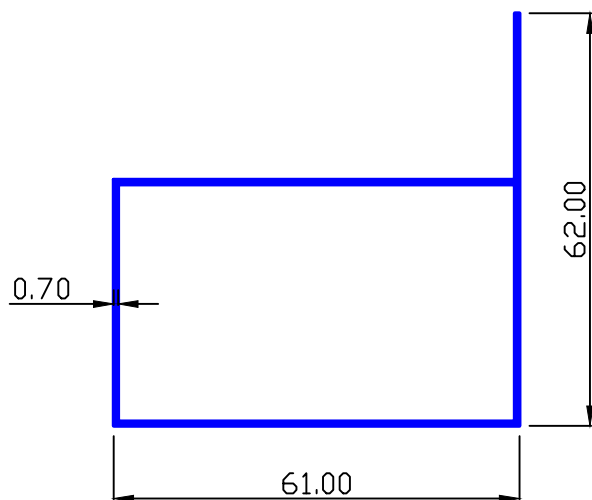

MAAN SEC.-8086

1.045 Kg/Mtr.

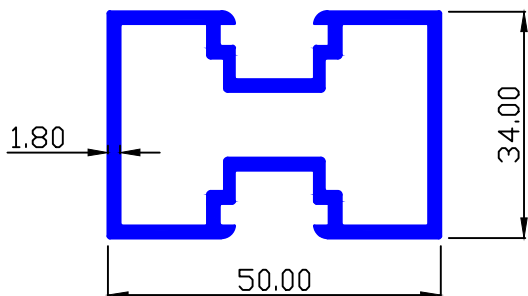

MAAN SEC.-89038

0.826 Kg/Mtr.

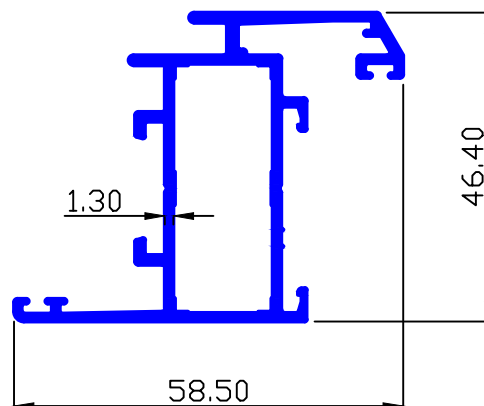



ARCHITECTURAL SECTION

MAAN SEC.-89039

0.217 Kg/Mtr.

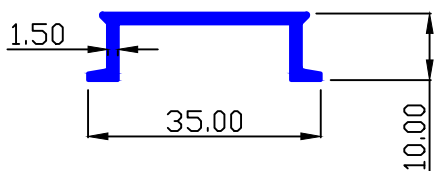

MAAN SEC.-89257

1.185 Kg/Mtr.

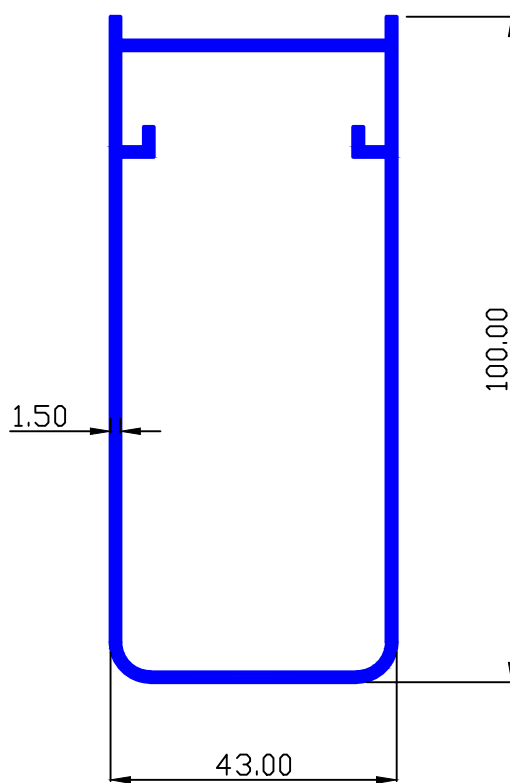

MAAN SEC.-89040

0.176 Kg/Mtr.

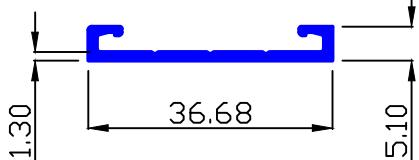

MAAN SEC.-89041

0.645 Kg/Mtr.

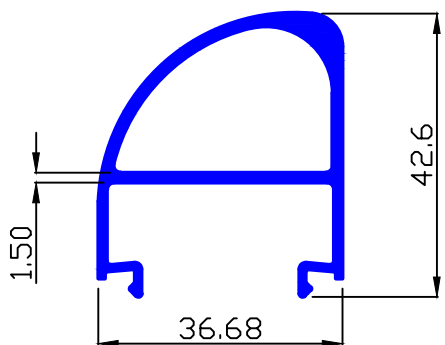

MAAN SEC.-89042

0.875 Kg/Mtr.

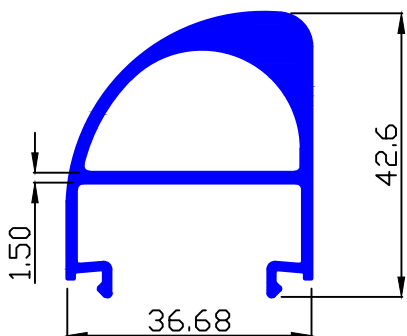

MAAN SEC.-89308

0.226 Kg/Mtr.

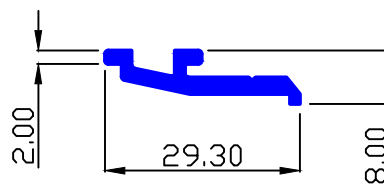

MAAN SEC.-89048

0.112 Kg/Mtr.

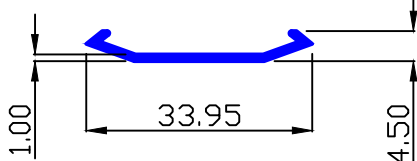

MAAN SEC.-89318

0.755 Kg/Mtr.

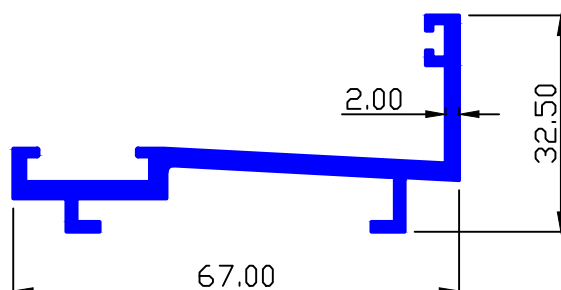



ARCHITECTURAL SECTION

MAAN SEC.-89405

0.707 Kg/Mtr.

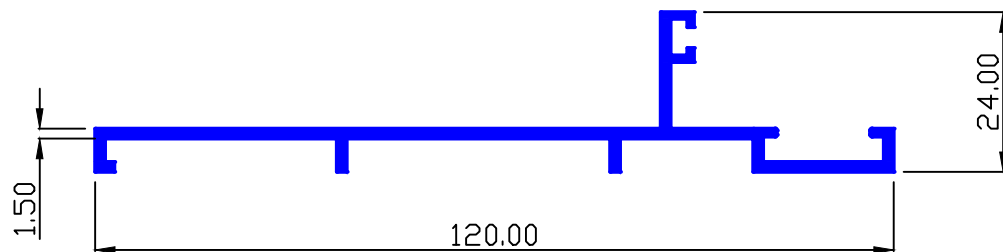

MAAN SEC.-89536

0.349 Kg/Mtr.

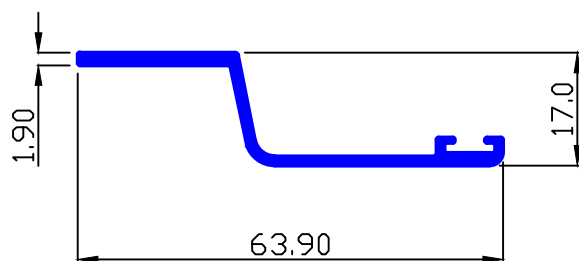

MAAN SEC.-89737

0.500 Kg/Mtr.

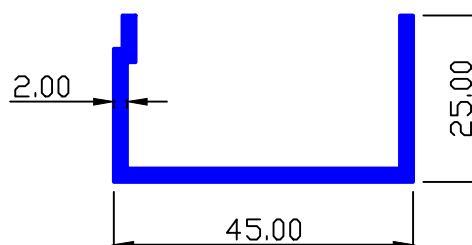

MAAN SEC.-89734

0.303 Kg/Mtr.

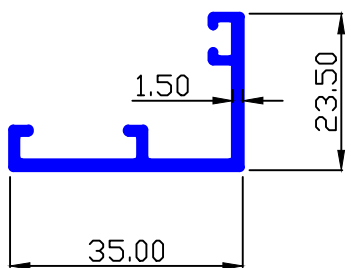

MAAN SEC.-89788

0.366 Kg/Mtr.

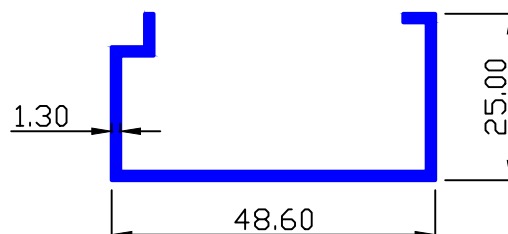

MAAN SEC.-89736

0.558 Kg/Mtr.

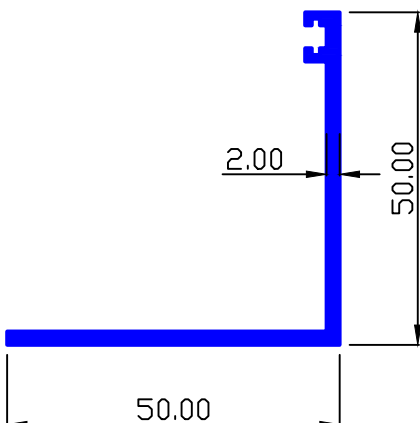

MAAN SEC.-89840

0.220 Kg/Mtr.

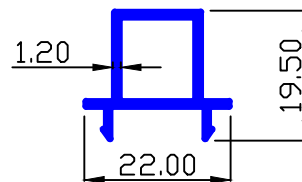

MAAN SEC.-89843

0.509 Kg/Mtr.

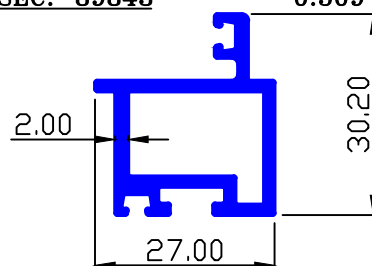



ARCHITECTURAL SECTION

MAAN SEC.-89811

2.531 Kg/Mtr.

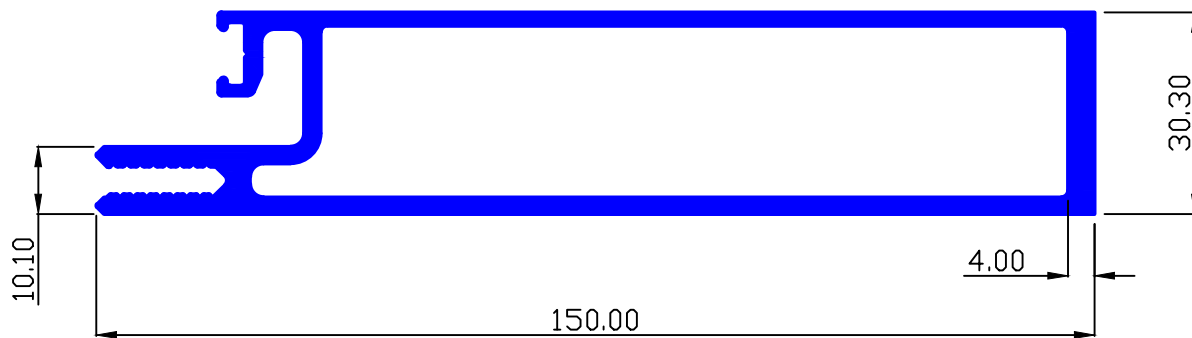

MAAN SEC.-89829

2.889 Kg/Mtr.

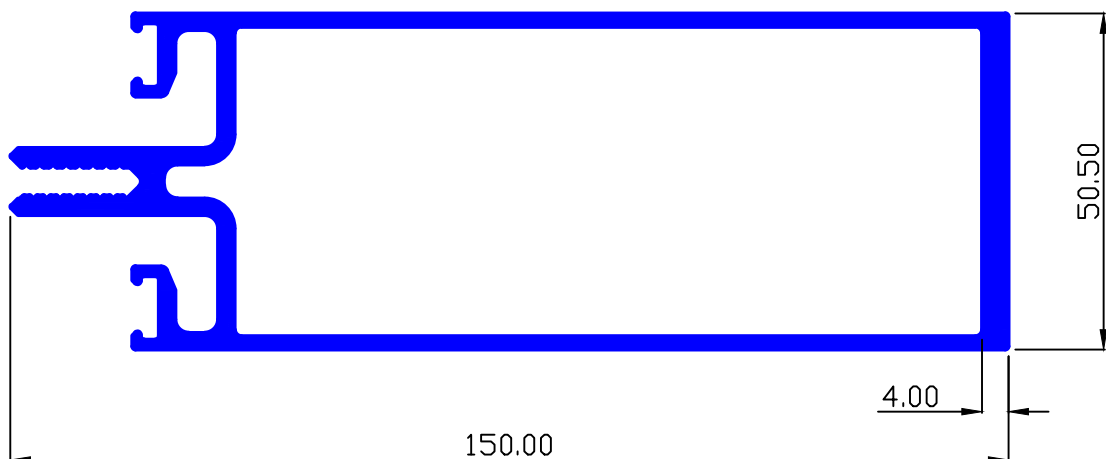

MAAN SEC.-89842

1.510 Kg/Mtr.

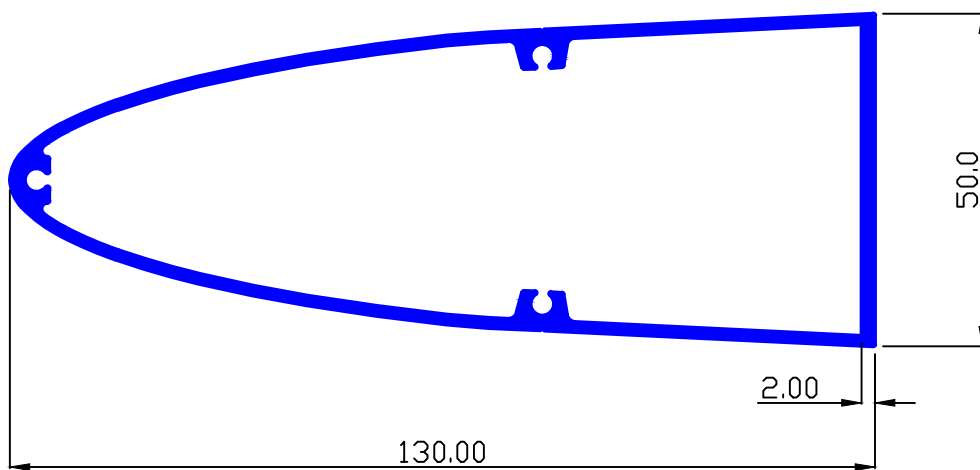



ARCHITECTURAL SECTION

MAAN SEC.-89844

1.526 Kg/Mtr.

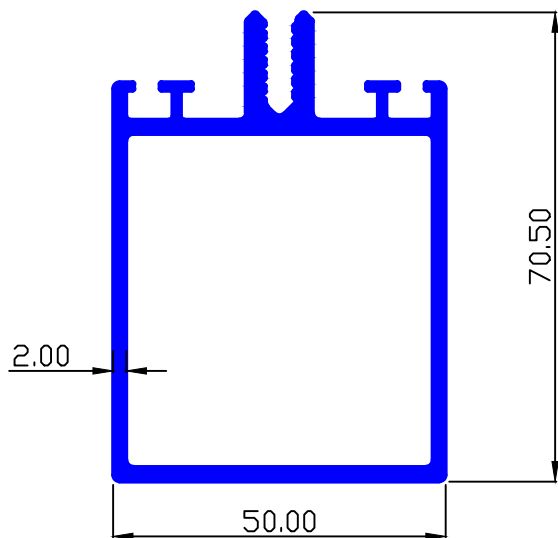

MAAN SEC.-89853

1.794 Kg/Mtr.

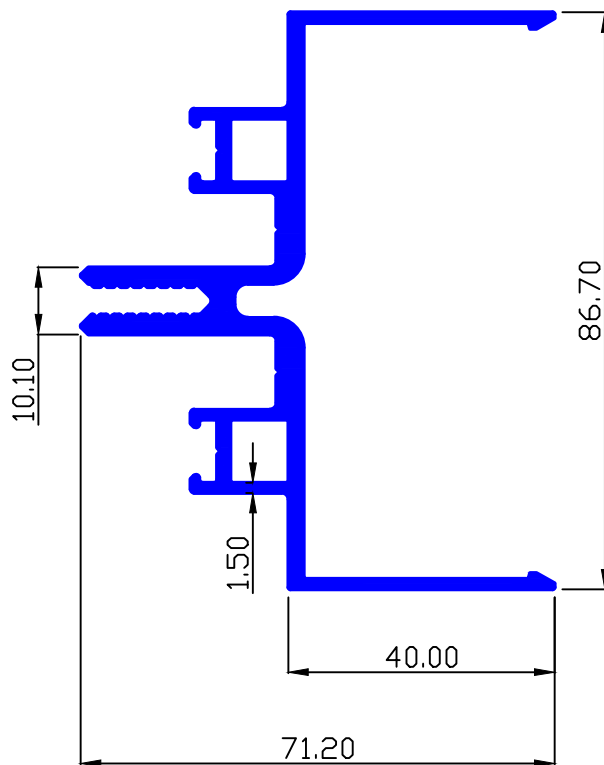

MAAN SEC.-89851

0.577 Kg/Mtr.

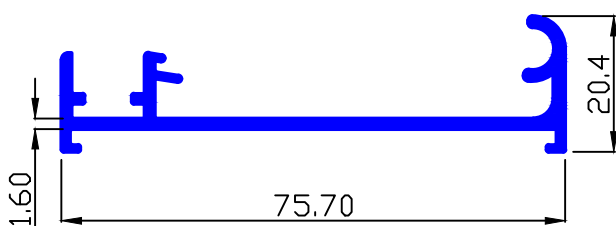

MAAN SEC.-89852

1.945 Kg/Mtr.

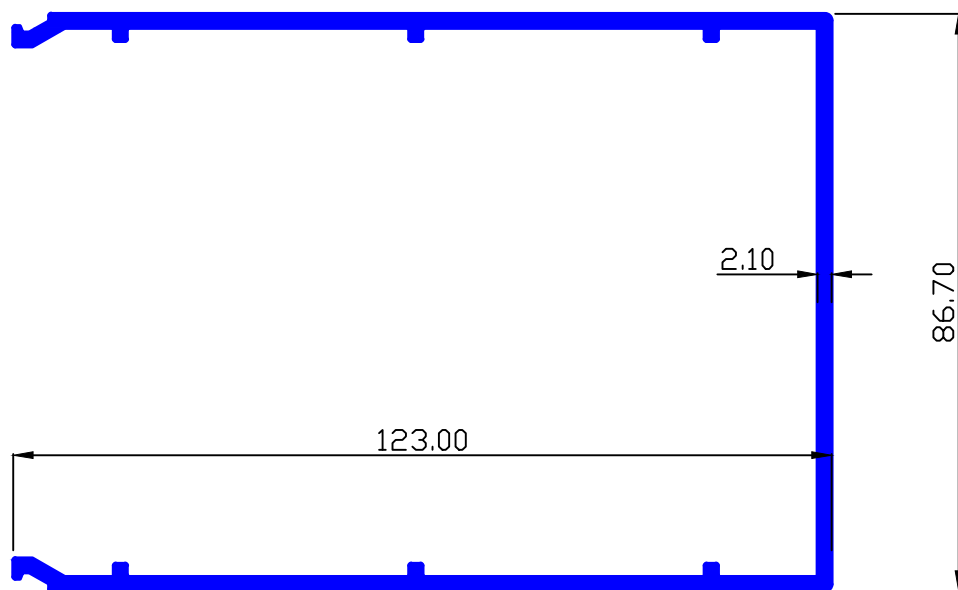



ARCHITECTURAL SECTION

MAAN SEC.-7010

0.312 Kg/Mtr.

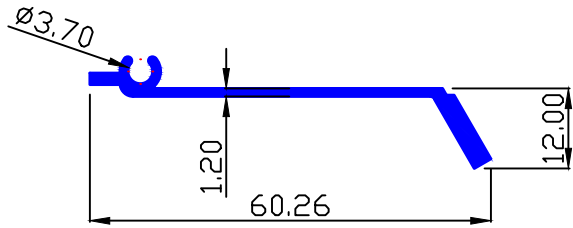

MAAN SEC.-7054

0.289 Kg/Mtr.

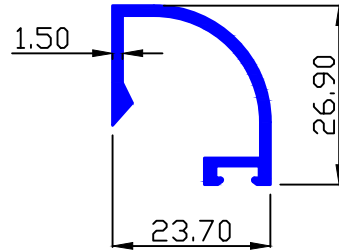

MAAN SEC.-7012

1.642 Kg/Mtr.

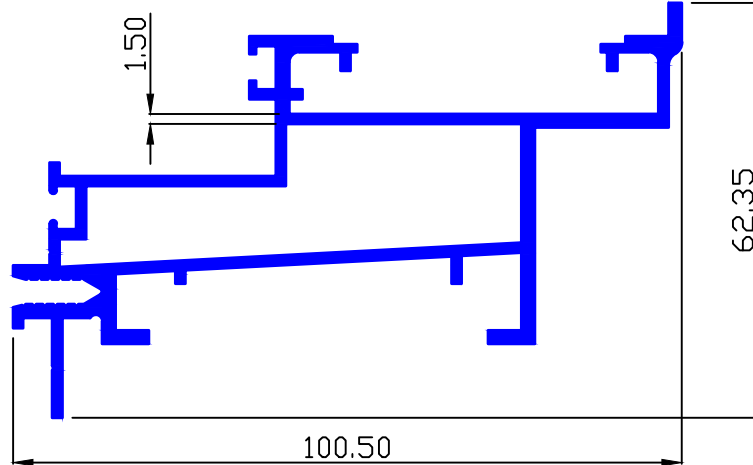

MAAN SEC.-7053

1.083 Kg/Mtr.

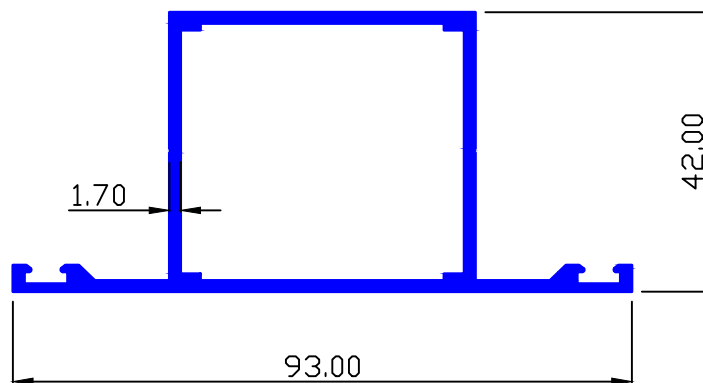

ARCHITECTURAL SECTION

1.586 Kg/Mtr.

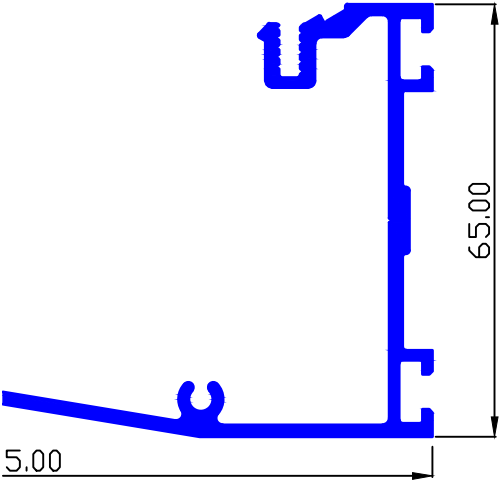

0.622 Kg/Mtr.

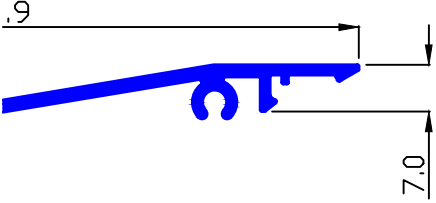

MAAN SEC.- 90726

2.098 Kg/Mtr.

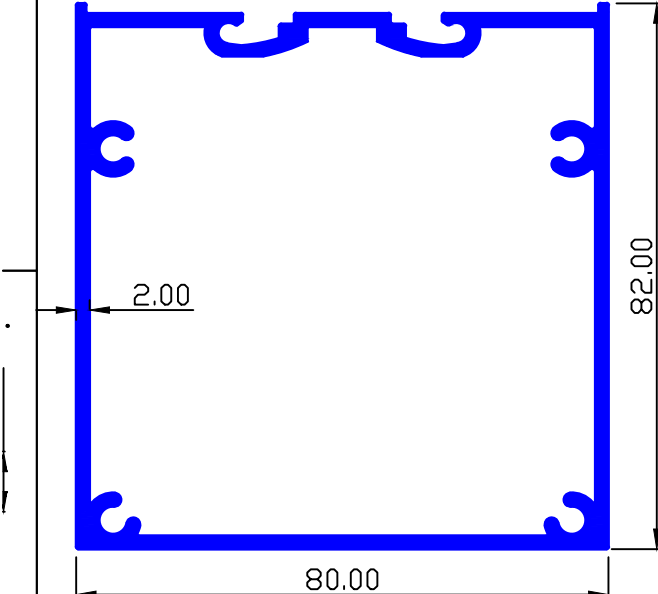

94 Kg/Mtr.

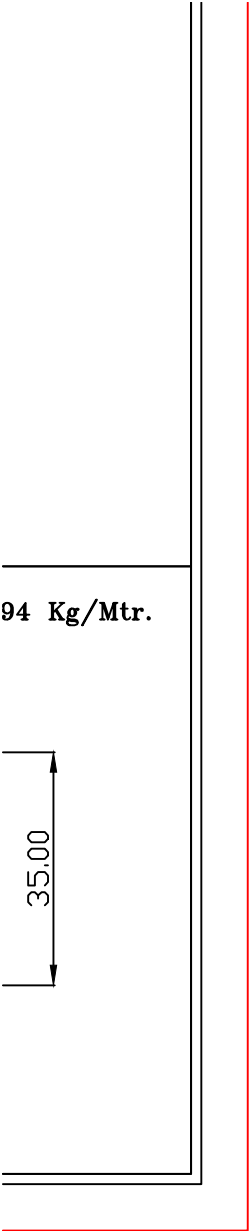



ARCHITECTURAL SECTION

MAAN SEC.-8726

1.201 Kg/Mtr.

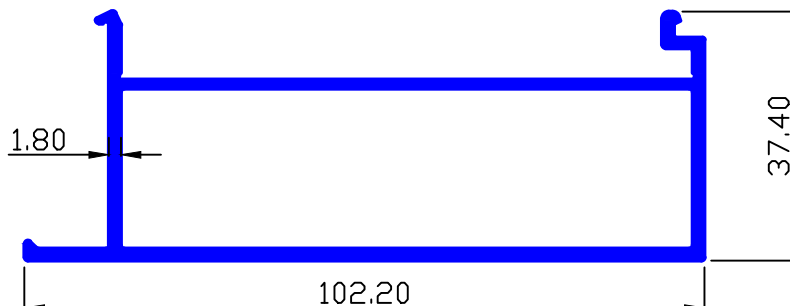

MAAN SEC.-90568

0.459 Kg/Mtr.

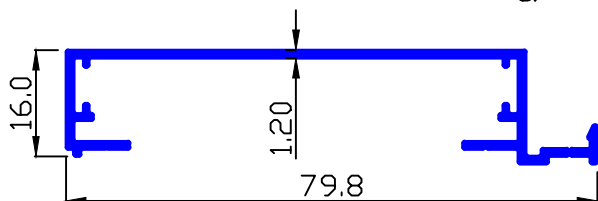

MAAN SEC.-90570

0.385 Kg/Mtr.

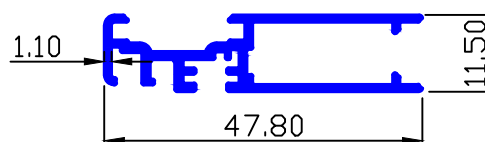

MAAN SEC.-90569

0.200 Kg/Mtr.

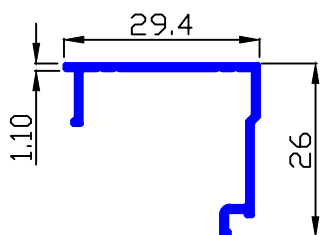

MAAN SEC.-90717

0.168 Kg/Mtr.

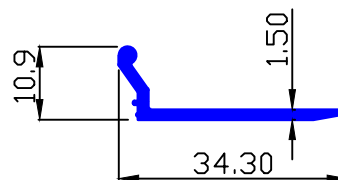

MAAN SEC.-90718

0.348 Kg/Mtr.

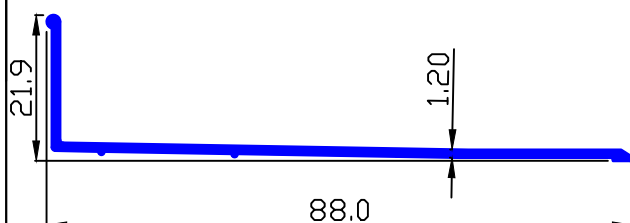

MAAN SEC.-90719

0.499 Kg/Mtr.

