

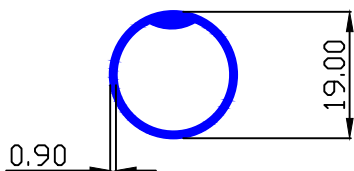

ARCHITECTURAL MISCELLANEOUS

MAAN SEC.-9034

0.163 Kg/Mtr.



MAAN SEC.-8055

0.146 Kg/Mtr.

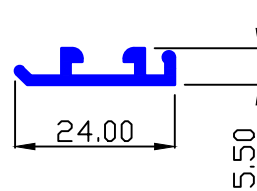

MAAN SEC.-6767

1.215 Kg/Mtr.

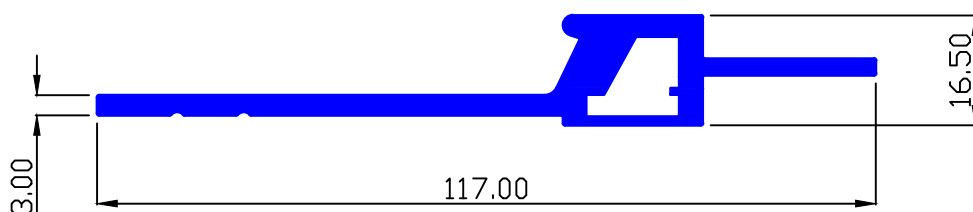

MAAN SEC.-6830

0.782 Kg/Mtr.

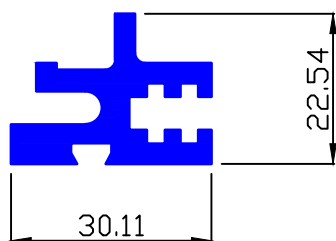

MAAN SEC.-6831

0.847 Kg/Mtr.

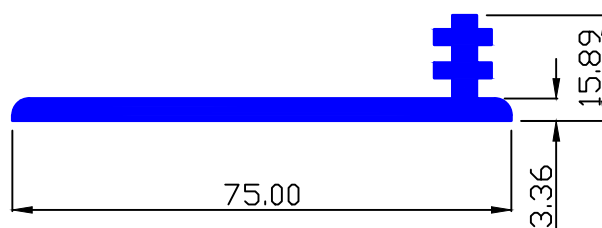

MAAN SEC.-6832

0.606 Kg/Mtr.

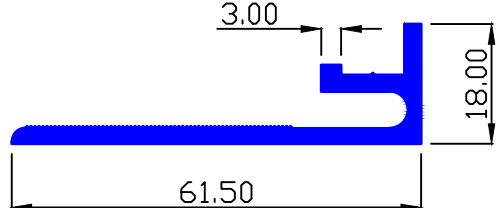

MAAN SEC.-6834

0.575 Kg/Mtr.

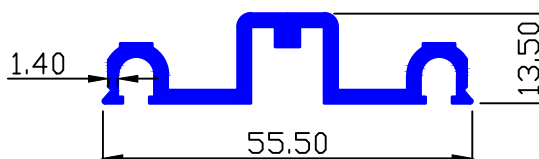

MAAN SEC.-7045

0.796 Kg/Mtr.

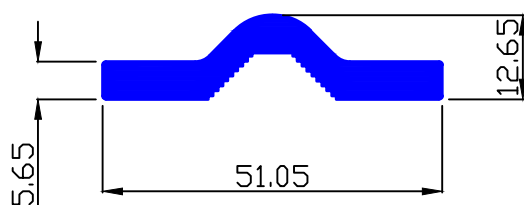

MAAN SEC.-7633

1.966 Kg/Mtr.

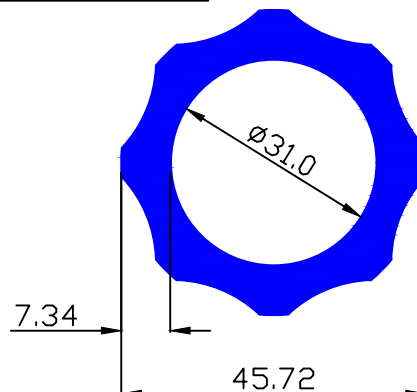



ARCHITECTURAL MISCELLANEOUS

MAAN SEC.-7043

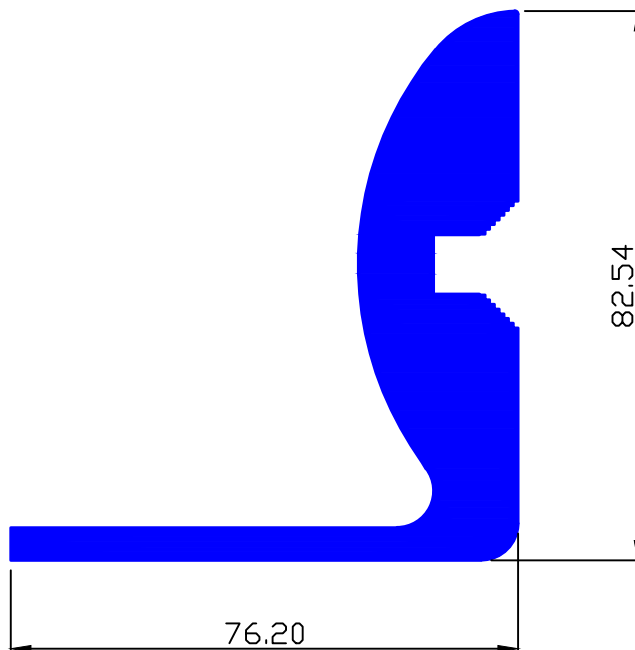

4.561 Kg/Mtr.

MAAN SEC.-7044

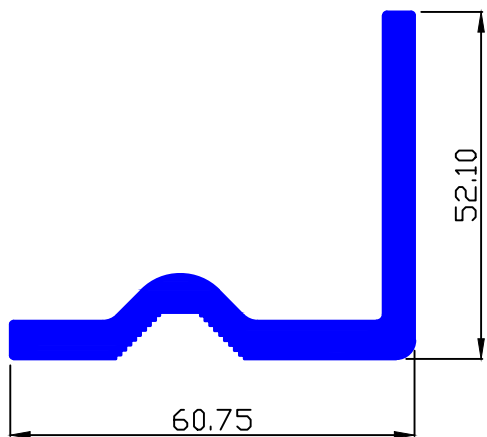

1.530 Kg/Mtr.

MAAN SEC.-7848

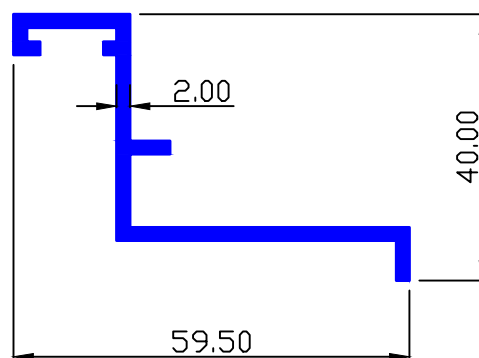

0.608 Kg/Mtr.

MAAN SEC.-7849

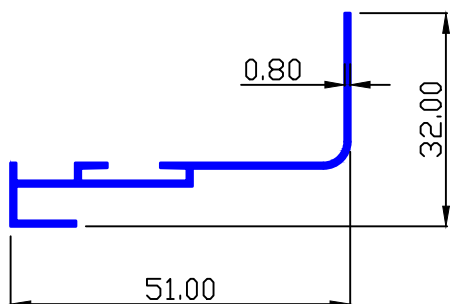

0.227 Kg/Mtr.

MAAN SEC.-9154

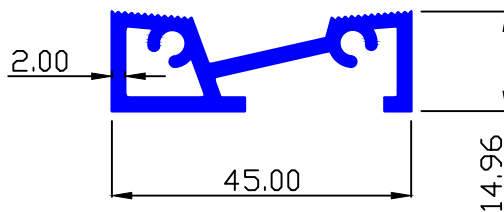

0.599 Kg/Mtr.



ARCHITECTURAL MISCELLANEOUS

MAAN SEC.-7815

5.174 Kg/Mtr.

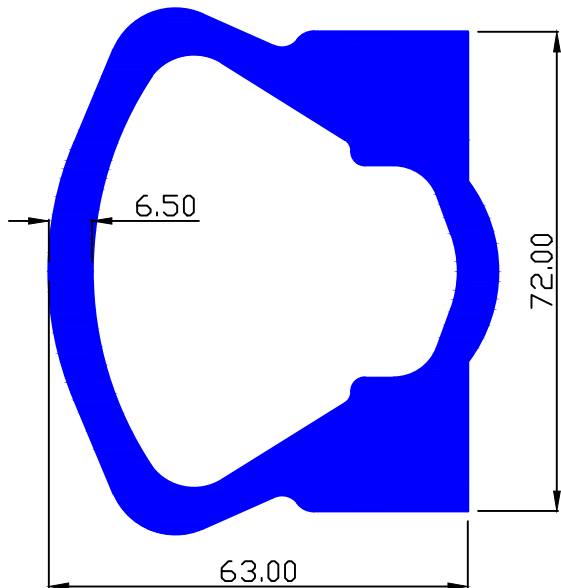

MAAN SEC.-9153

0.204 Kg/Mtr.

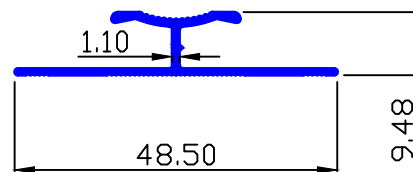

MAAN SEC.-7851

0.302 Kg/Mtr.

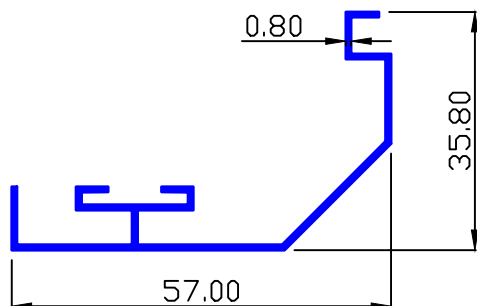

MAAN SEC.-9212

0.266 Kg/Mtr.

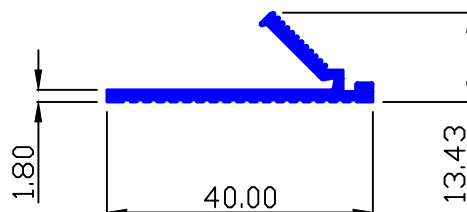

MAAN SEC.-7855

1.305 Kg/Mtr.

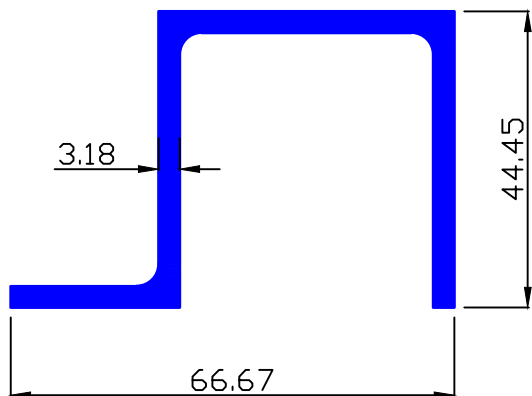

MAAN SEC.-9238

0.392 Kg/Mtr.

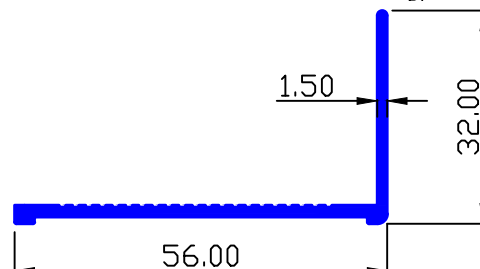



ARCHITECTURAL MISCELLANEOUS

**MAAN SEC.-9115**

0.274 Kg/Mtr.

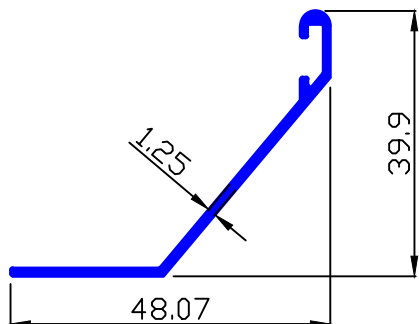

**MAAN SEC.-9142**

0.314 Kg/Mtr.

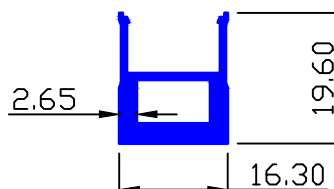

**MAAN SEC.-9147**

0.232 Kg/Mtr.

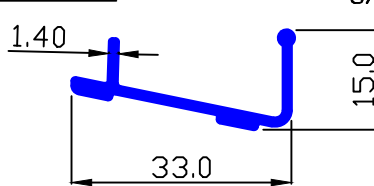

**MAAN SEC.-9130**

2.361 Kg/Mtr.

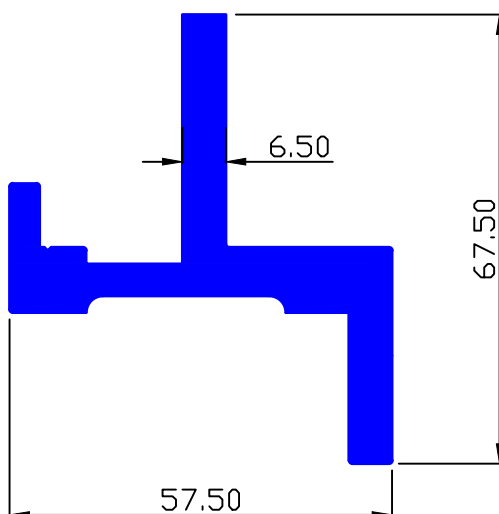

**MAAN SEC.-9148**

0.192 Kg/Mtr.

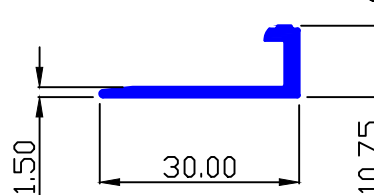

**MAAN SEC.-9149**

0.236 Kg/Mtr.

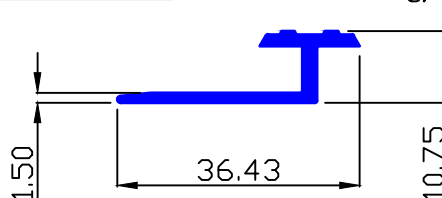

**MAAN SEC.-9136**

0.591 Kg/Mtr.

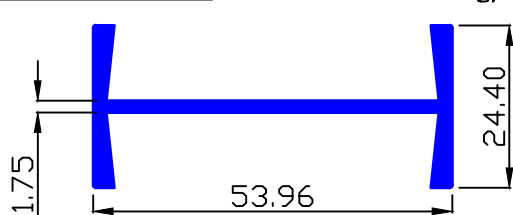

**MAAN SEC.-9155**

0.674 Kg/Mtr.

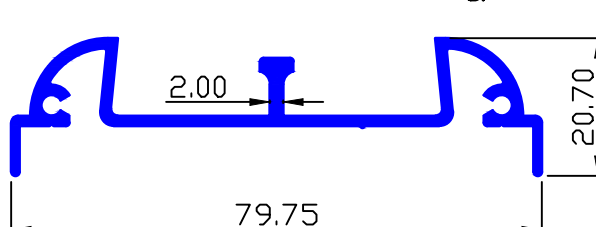

**MAAN SEC.-9137**

0.677 Kg/Mtr.

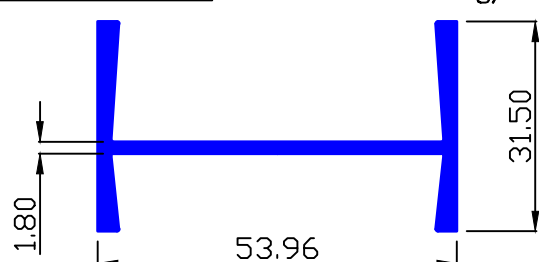



ARCHITECTURAL MISCELLANEOUS

MAAN SEC.-9239

0.533 Kg/Mtr.

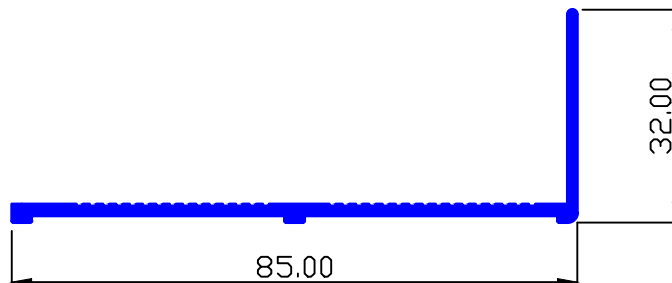

MAAN SEC.-9241

0.535 Kg/Mtr.

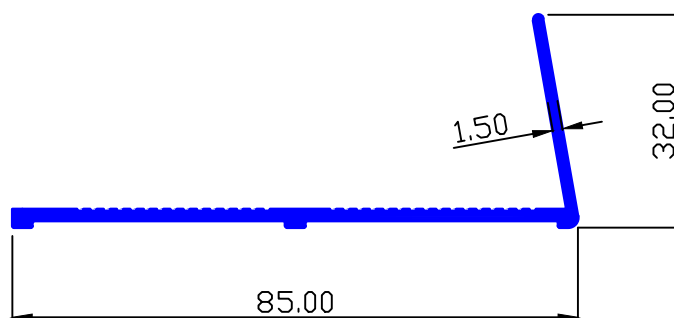

MAAN SEC.-9159

1.158 Kg/Mtr.

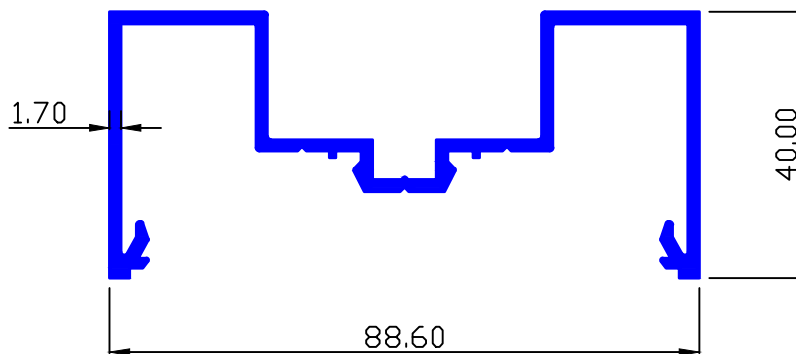

MAAN SEC.-9160

1.095 Kg/Mtr.

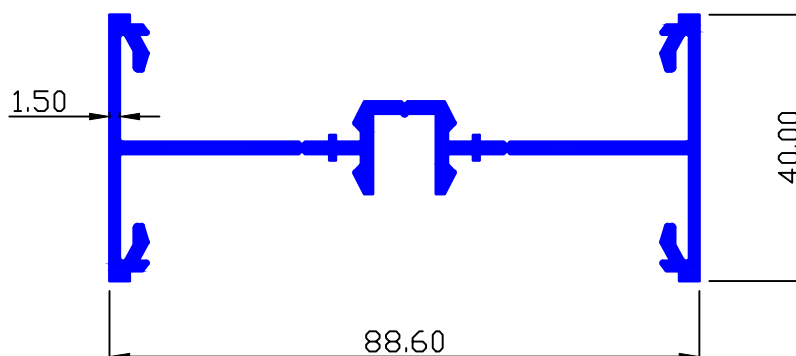



ARCHITECTURAL MISCELLANEOUS

MAAN SEC.-9192

0.600 Kg/Mtr.

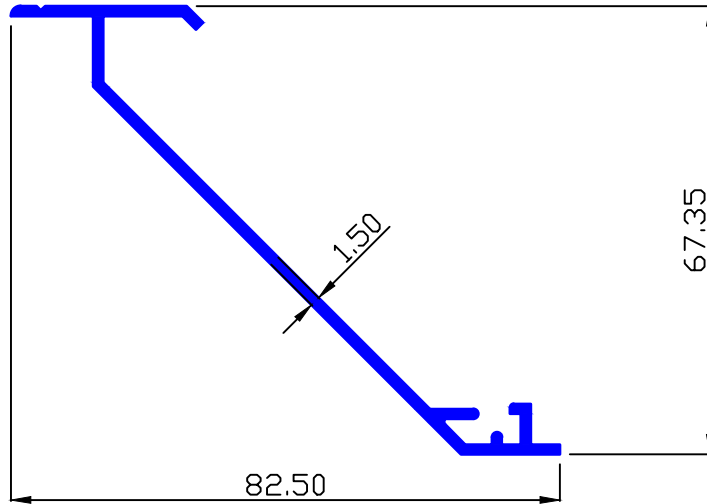

MAAN SEC.-9194

0.187 Kg/Mtr.

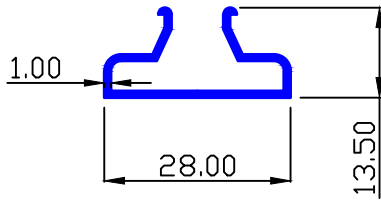

MAAN SEC.-9238

0.392 Kg/Mtr.

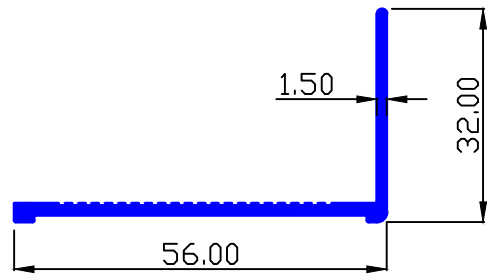

MAAN SEC.-9207

0.591 Kg/Mtr.

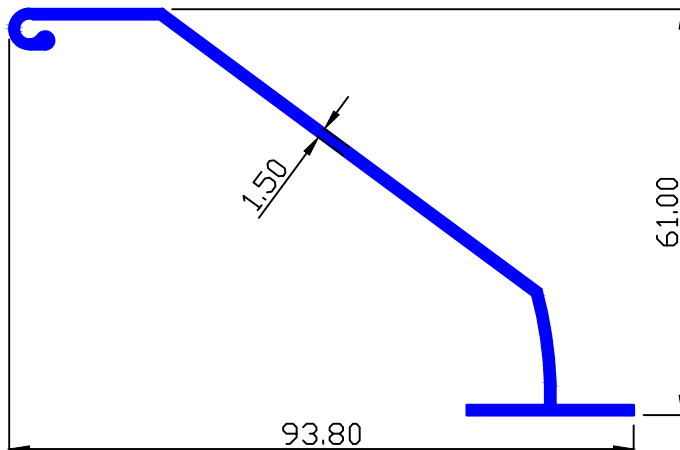



ARCHITECTURAL MISCELLANEOUS

MAAN SEC.-9208

0.729 Kg/Mtr.

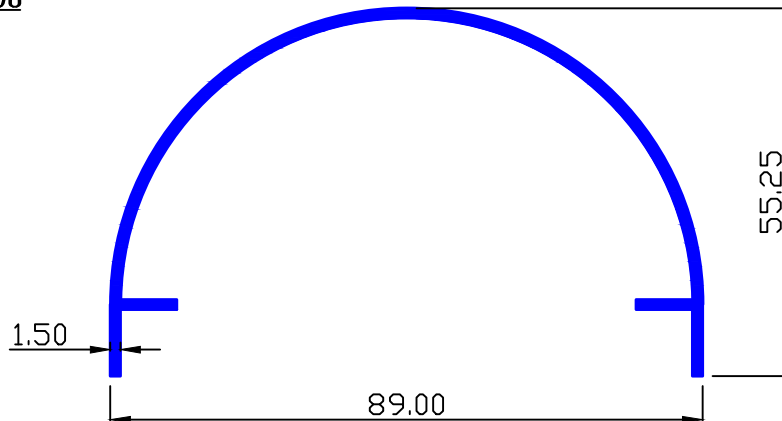

MAAN SEC.-9242

0.325 Kg/Mtr.

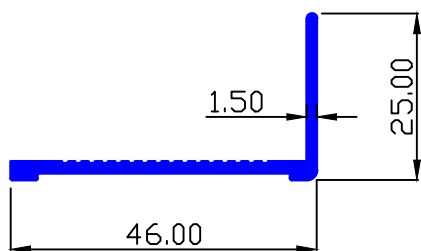

MAAN SEC.-9213

0.476 Kg/Mtr.

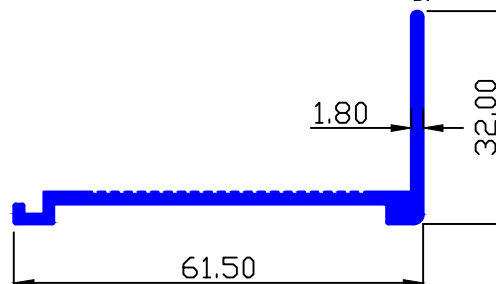

MAAN SEC.-9214

0.659 Kg/Mtr.

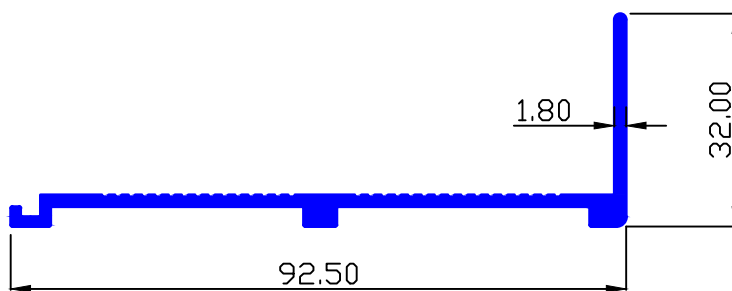

MAAN SEC.-9216

0.786 Kg/Mtr.

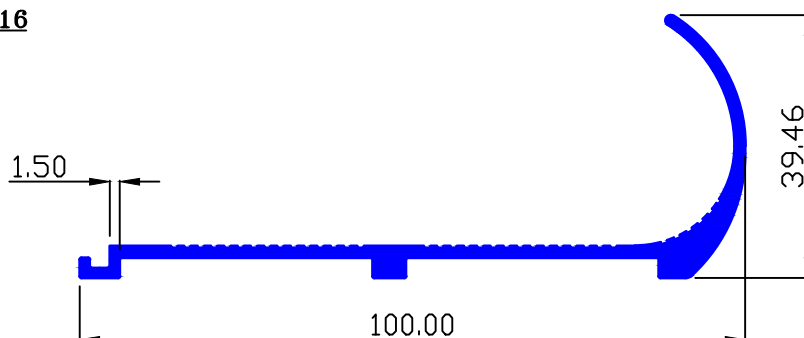



ARCHITECTURAL MISCELLANEOUS

MAAN SEC.-9215

0.603 Kg/Mtr.

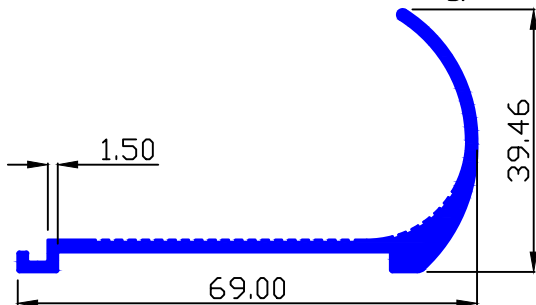

MAAN SEC.-9243

0.452 Kg/Mtr.

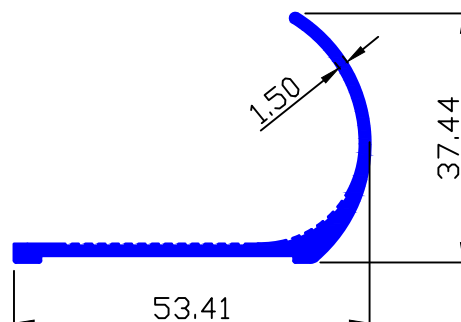

MAAN SEC.-9218

0.658 Kg/Mtr.

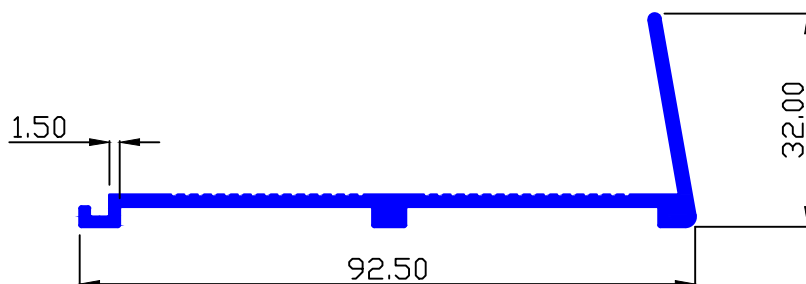

MAAN SEC.-9220

1.643 Kg/Mtr.

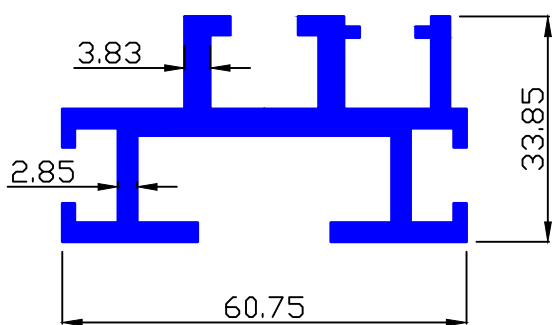

MAAN SEC.-9230

0.584 Kg/Mtr.

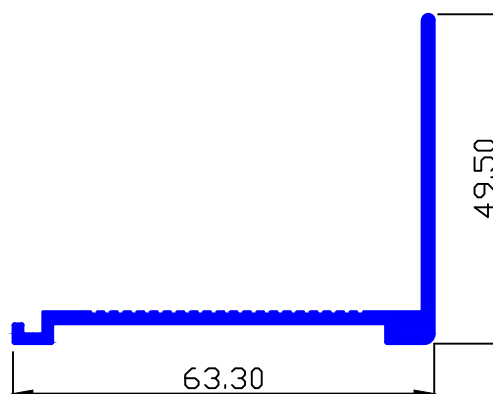

MAAN SEC.-9231

0.711 Kg/Mtr.

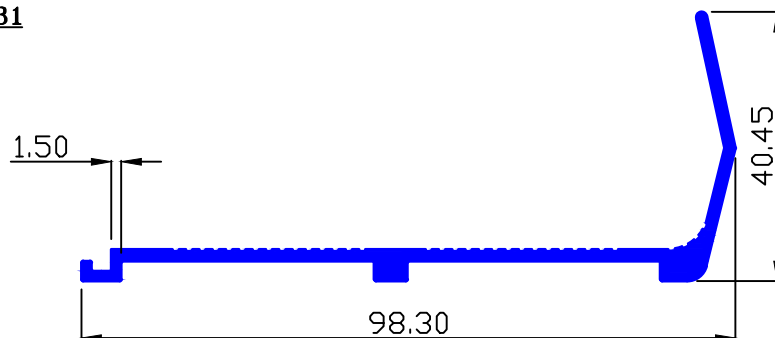



ARCHITECTURAL MISCELLANEOUS

MAAN SEC.-9232

0.796 Kg/Mtr.

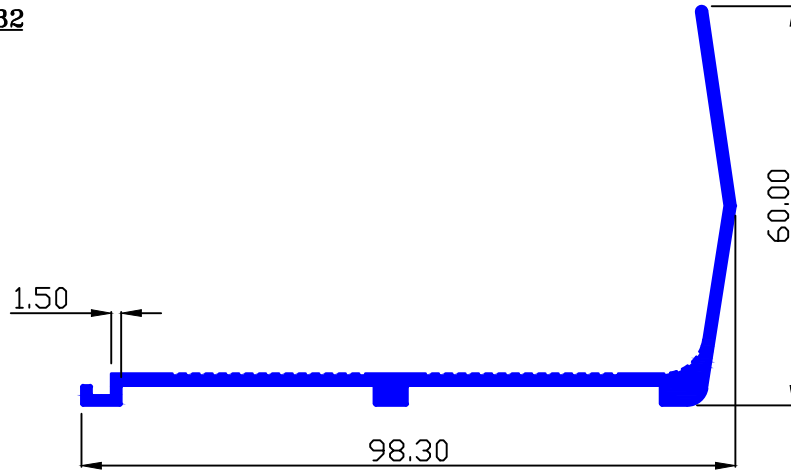

MAAN SEC.-9246

0.463 Kg/Mtr.

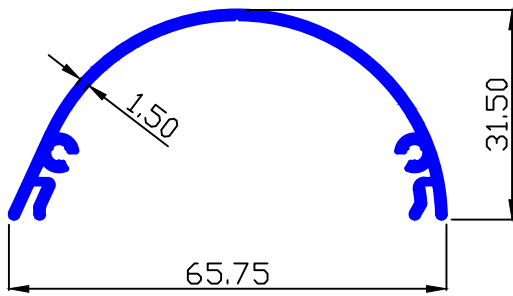

MAAN SEC.-9244

0.463 Kg/Mtr.

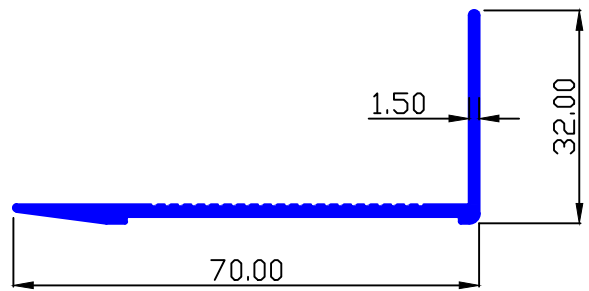

MAAN SEC.-9247

0.461 Kg/Mtr.

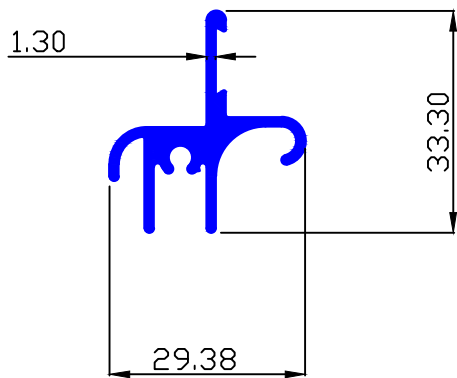

MAAN SEC.-9249

0.455 Kg/Mtr.

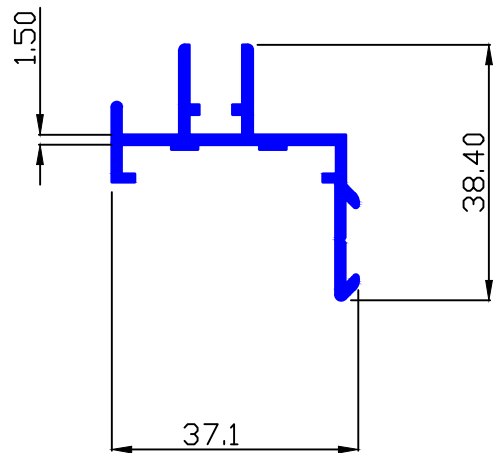



ARCHITECTURAL MISCELLANEOUS

MAAN SEC.-9256

0.638 Kg/Mtr.

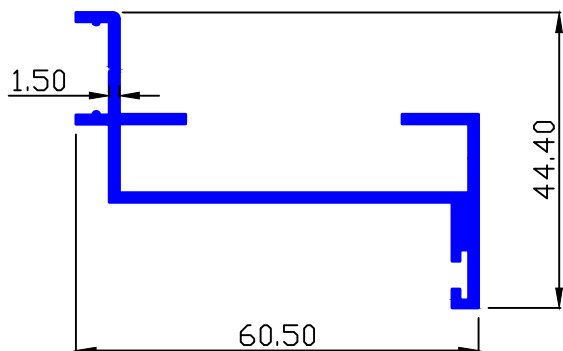

MAAN SEC.-9250

0.293 Kg/Mtr.

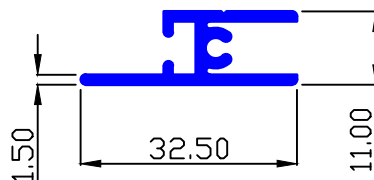

MAAN SEC.-9257

0.221 Kg/Mtr.

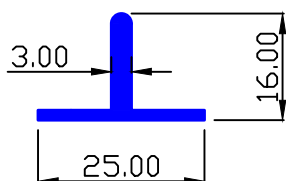

MAAN SEC.-9263

0.300 Kg/Mtr.

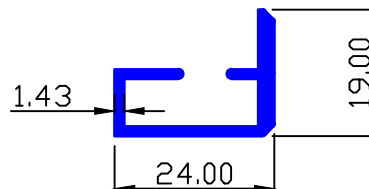

MAAN SEC.-9258

0.168 Kg/Mtr.

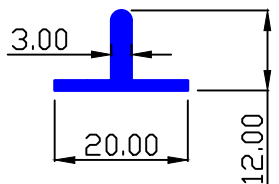

MAAN SEC.-9264

0.224 Kg/Mtr.

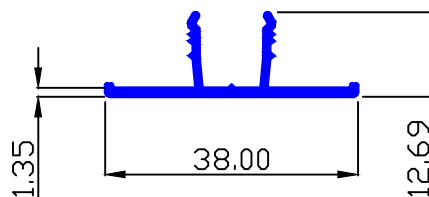

MAAN SEC.-9259

0.128 Kg/Mtr.

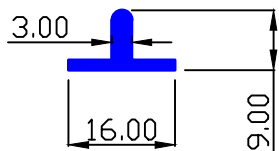

MAAN SEC.-9265

0.561 Kg/Mtr.

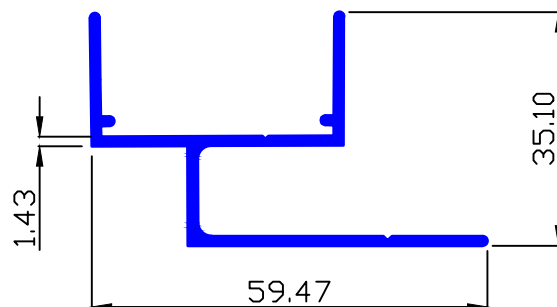

MAAN SEC.-9261

0.155 Kg/Mtr.

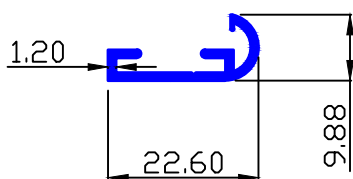

MAAN SEC.-9266

0.135 Kg/Mtr.

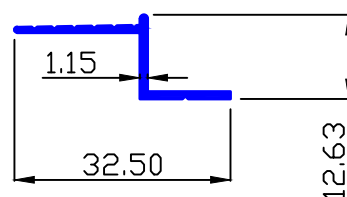



ARCHITECTURAL MISCELLANEOUS

MAAN SEC.-9267

1.950 Kg/Mtr.

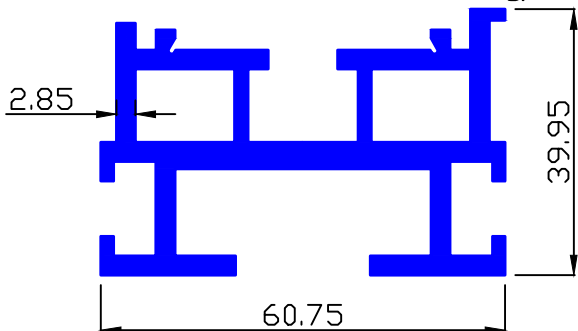

MAAN SEC.-9274

1.268 Kg/Mtr.

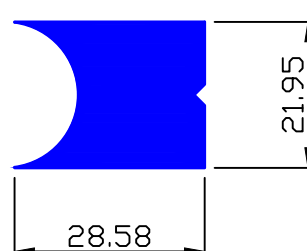

MAAN SEC.-9270

0.128 Kg/Mtr.

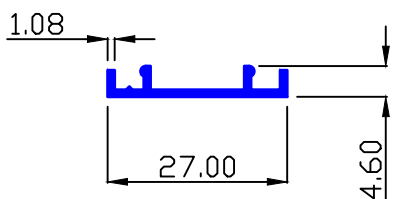

MAAN SEC.-9275

1.023 Kg/Mtr.

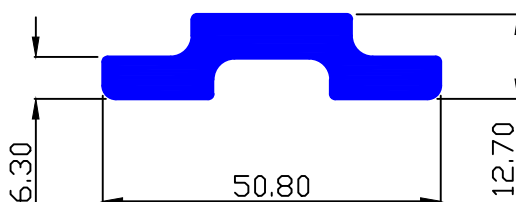

MAAN SEC.-9271

0.563 Kg/Mtr.

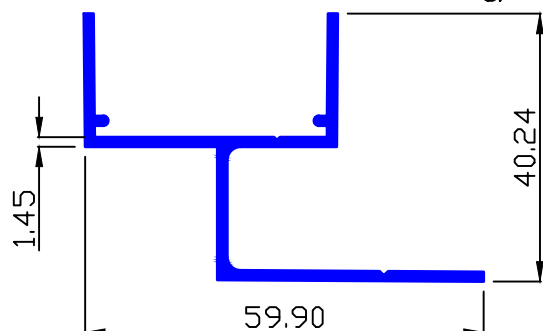

MAAN SEC.-9280

0.188 Kg/Mtr.

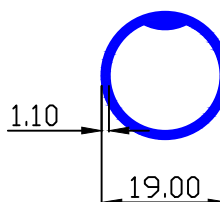

MAAN SEC.-9272

0.265 Kg/Mtr.

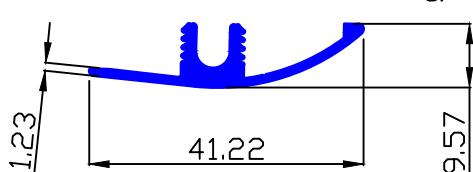

MAAN SEC.-9281

0.590 Kg/Mtr.

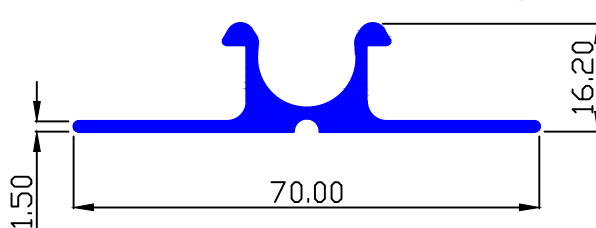

MAAN SEC.-9273

0.642 Kg/Mtr.

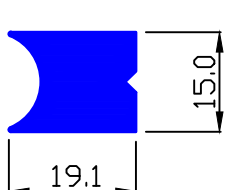

MAAN SEC.-9293

0.408 Kg/Mtr.

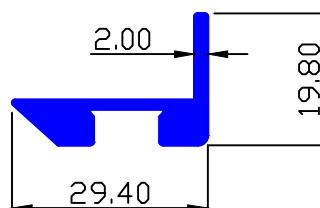



ARCHITECTURAL MISCELLANEOUS

MAAN SEC.-9282

1.290 Kg/Mtr.

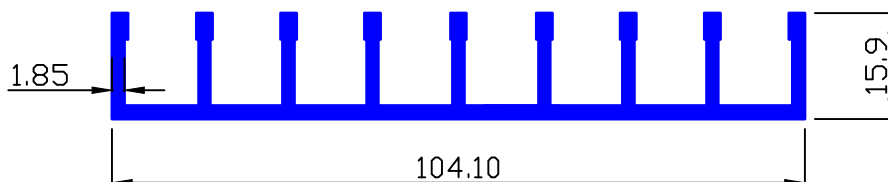

MAAN SEC.-9284

3.394 Kg/Mtr.

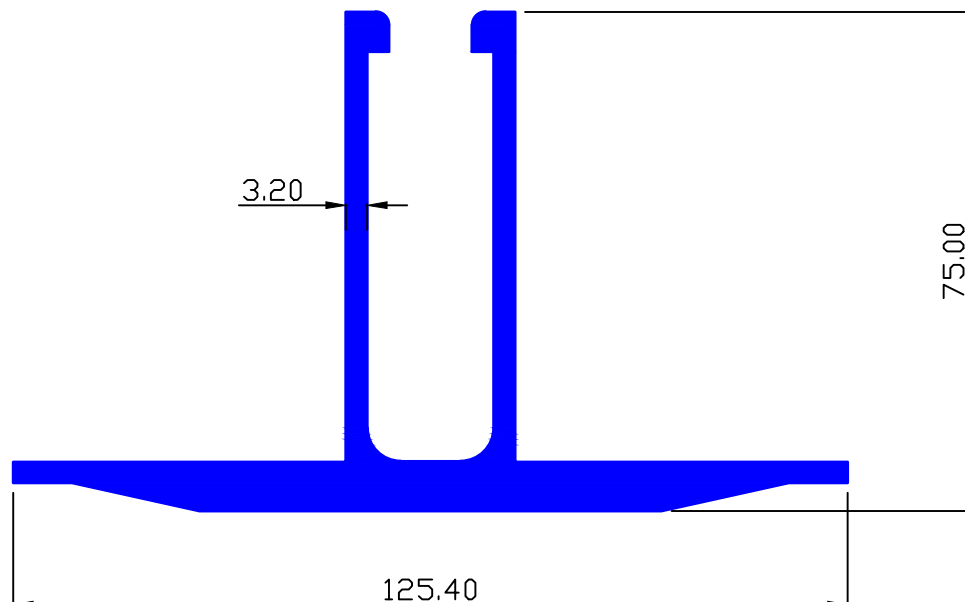

MAAN SEC.-9294

0.053Kg/Mtr.

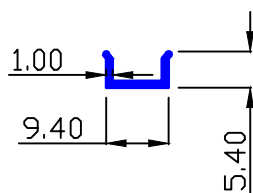

MAAN SEC.-9302

0.454Kg/Mtr.

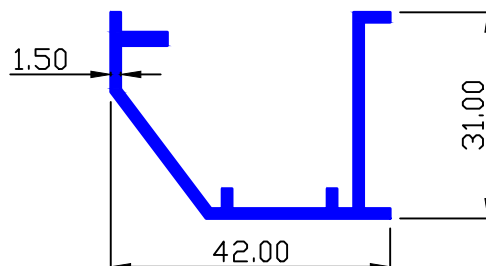

MAAN SEC.-9251

0.326 Kg/Mtr.

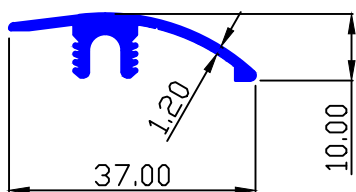

MAAN SEC.-9303

0.177 Kg/Mtr.

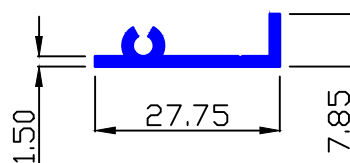



ARCHITECTURAL MISCELLANEOUS

**MAAN SEC.-9306**

3.562 Kg/Mtr.

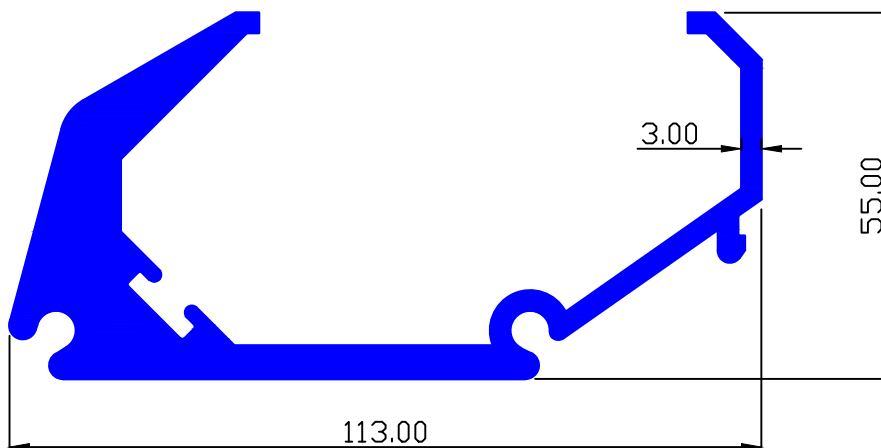

**MAAN SEC.-9307**

0.383 Kg/Mtr.

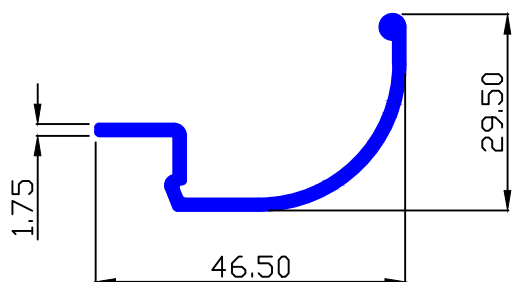

**MAAN SEC.-9308**

1.011 Kg/Mtr.

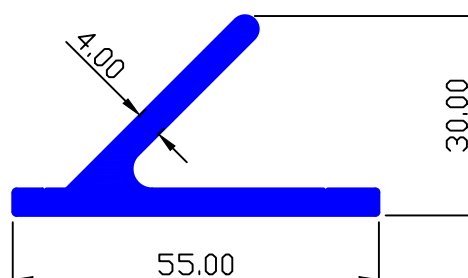

**MAAN SEC.-9309**

0.151 Kg/Mtr.

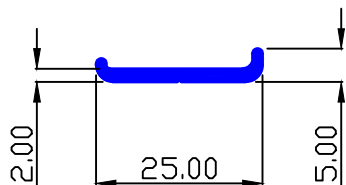

**MAAN SEC.-9312**

0.805 Kg/Mtr.

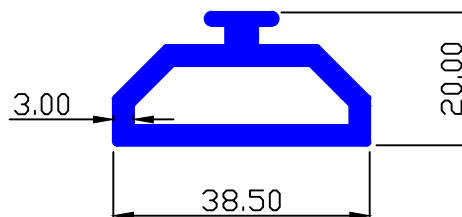

**MAAN SEC.-9313**

1.591 Kg/Mtr.

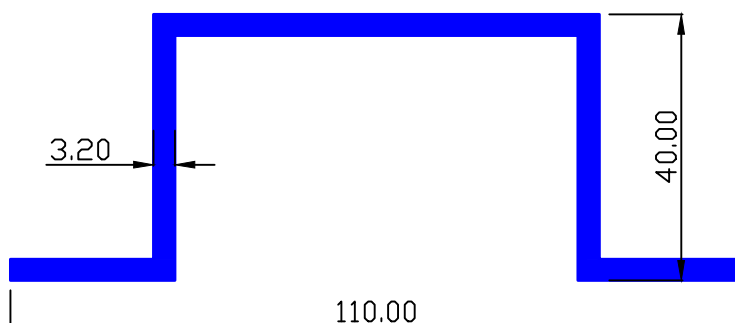



ARCHITECTURAL MISCELLANEOUS

MAAN SEC.-9310

1.235 Kg/Mtr.

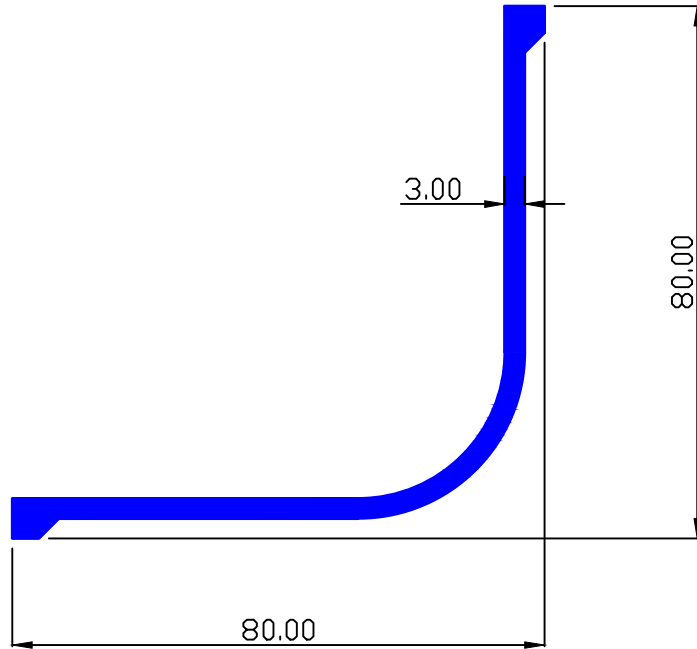

MAAN SEC.-9311

1.128 Kg/Mtr.

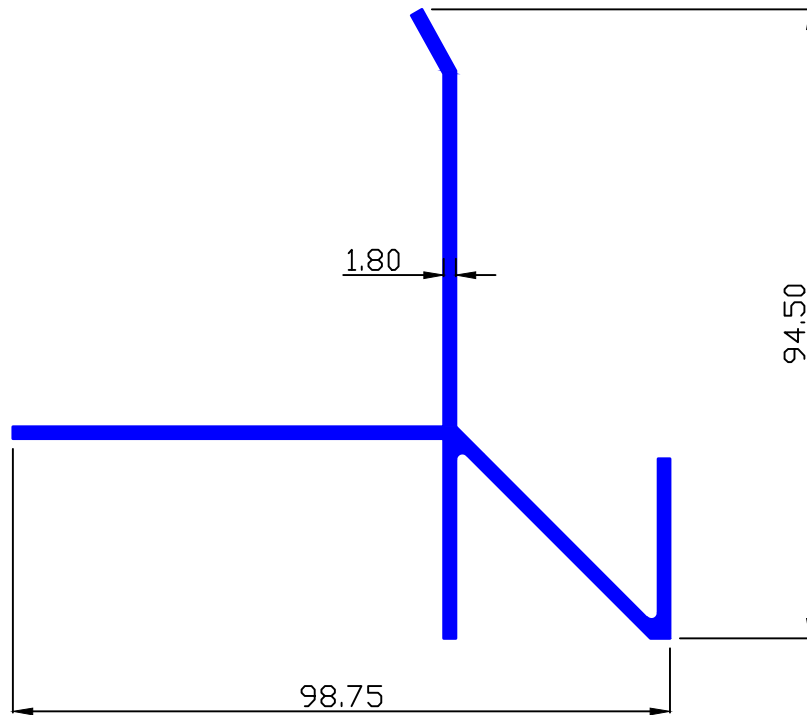



ARCHITECTURAL MISCELLANEOUS

MAAN SEC.-9314

1.295 Kg/Mtr.

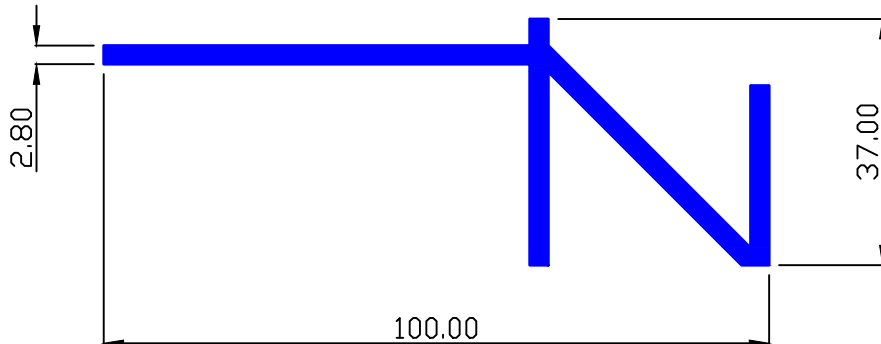

MAAN SEC.-9319

1.958 Kg/Mtr.

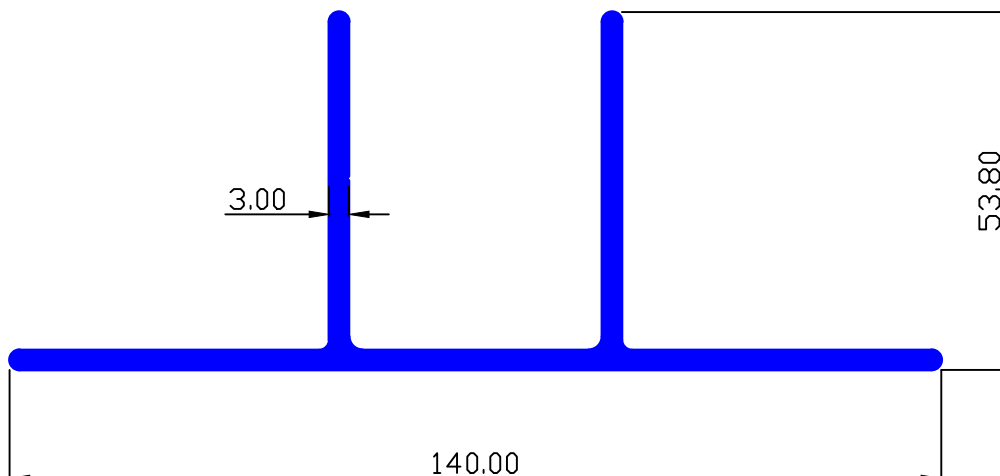

MAAN SEC.-9320

1.958 Kg/Mtr.

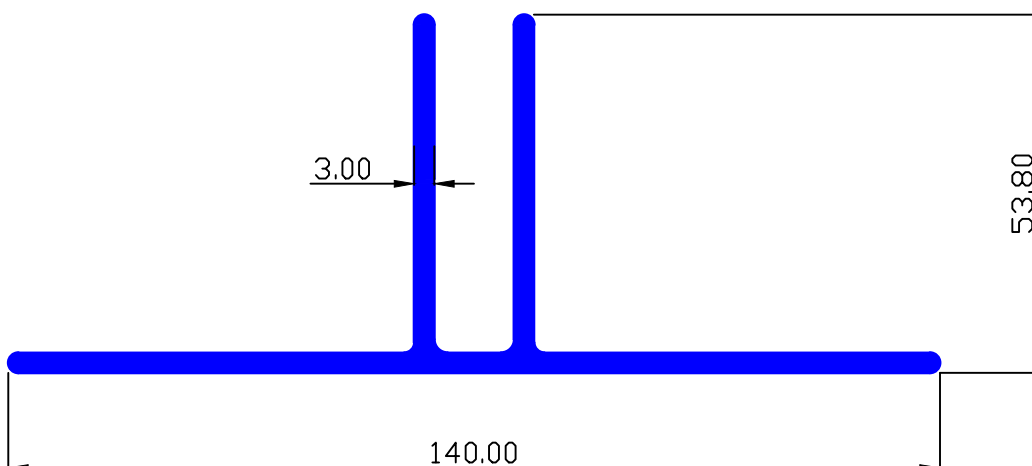



ARCHITECTURAL MISCELLANEOUS

MAAN SEC.-9253

0.238 Kg/Mtr.

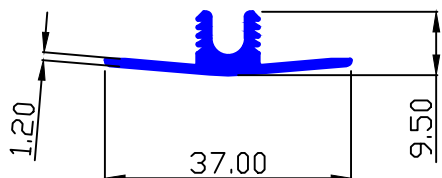

MAAN SEC.-9323

1.823 Kg/Mtr.

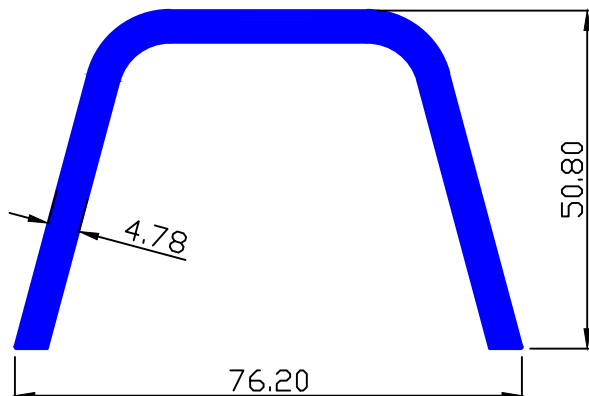

MAAN SEC.-9322

1.753 Kg/Mtr.

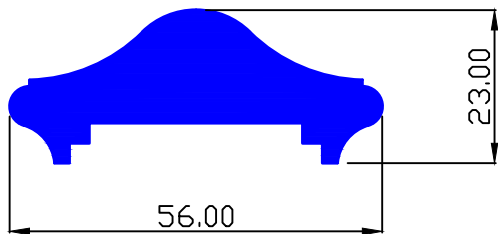

MAAN SEC.-9335

0.383 Kg/Mtr.

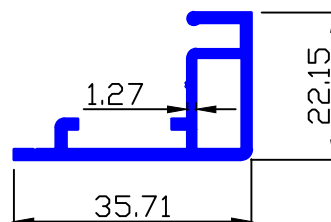

MAAN SEC.-9341

1.916 Kg/Mtr.

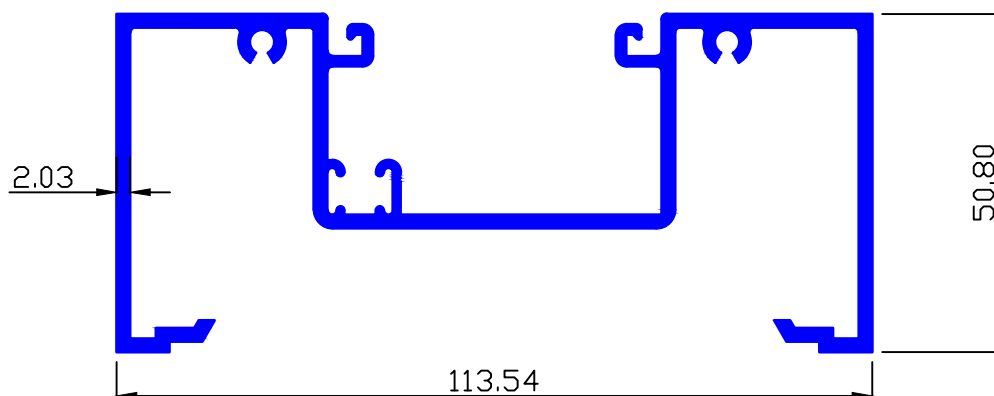

MAAN SEC.-9342

0.481 Kg/Mtr.

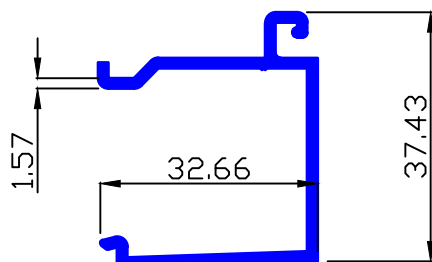

MAAN SEC.-9343

1.916 Kg/Mtr.

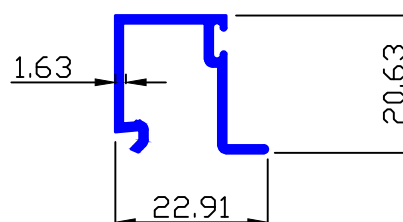



ARCHITECTURAL MISCELLANEOUS

MAAN SEC.-9344

0.403 Kg/Mtr.

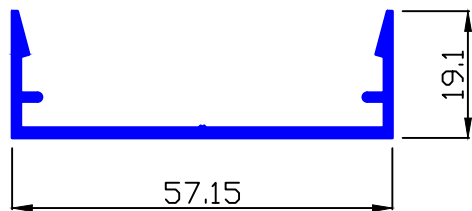

MAAN SEC.-9346

0.705 Kg/Mtr.

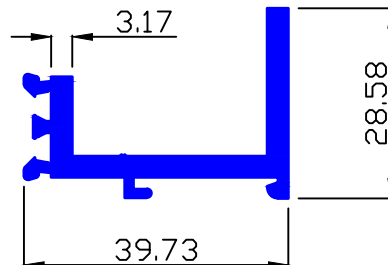

MAAN SEC.-9345

0.462 Kg/Mtr.

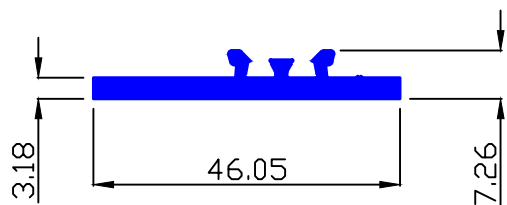

MAAN SEC.-9359

0.737 Kg/Mtr.

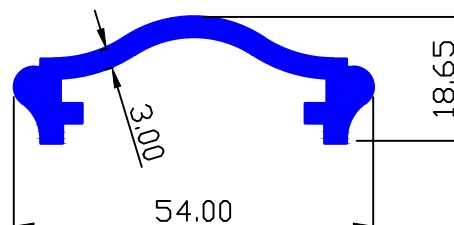

MAAN SEC.-9347

0.863 Kg/Mtr.

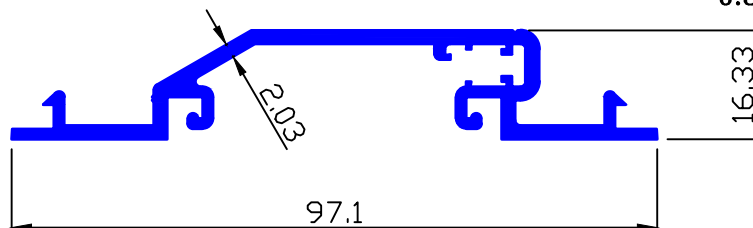

MAAN SEC.-9360

1.591 Kg/Mtr.

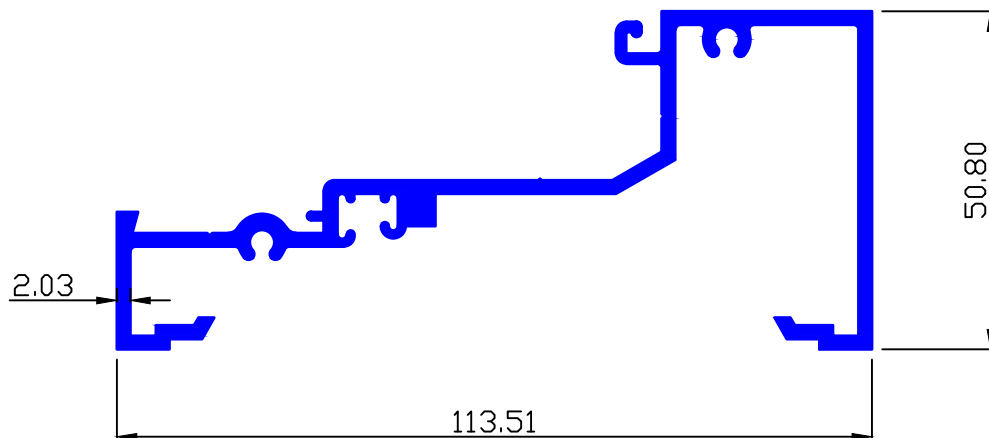



ARCHITECTURAL MISCELLANEOUS

MAAN SEC.-9358

0.819 Kg/Mtr.

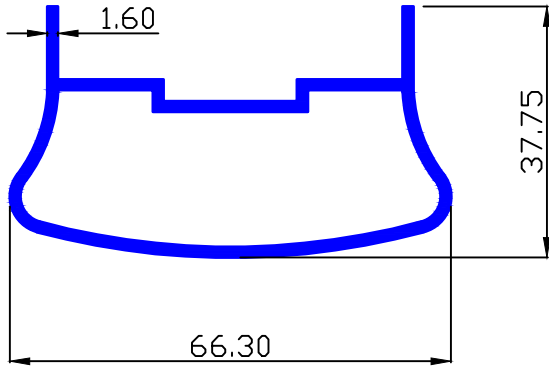

MAAN SEC.-9365

1.165 Kg/Mtr.

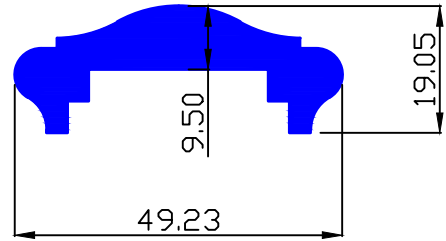

MAAN SEC.-9361

1.891 Kg/Mtr.

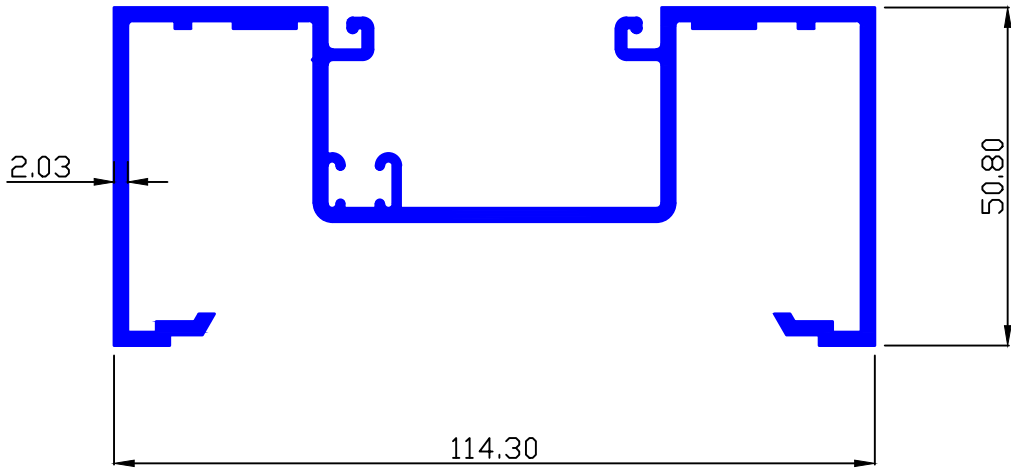

MAAN SEC.-9362

1.691 Kg/Mtr.

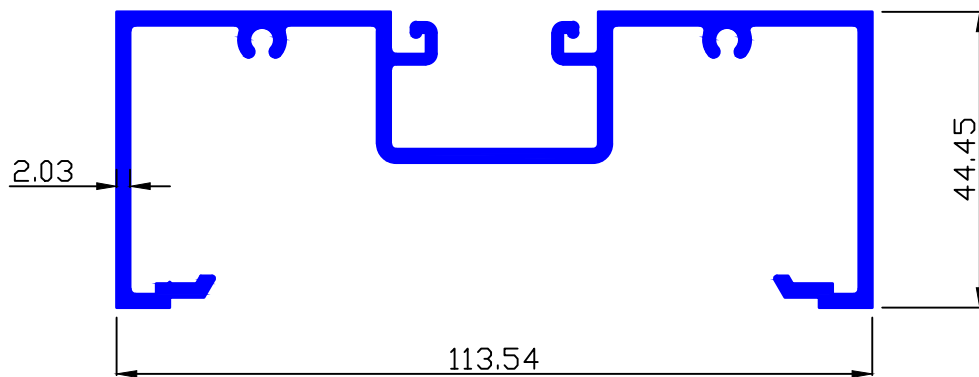



ARCHITECTURAL MISCELLANEOUS

MAAN SEC.-9363

1.740 Kg/Mtr.

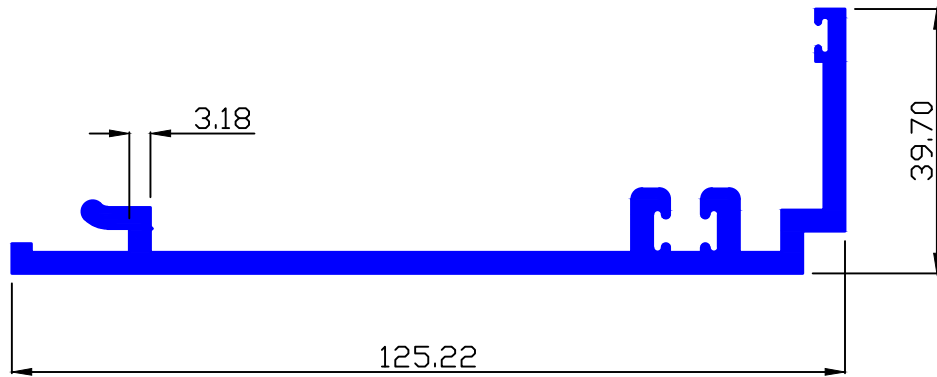

MAAN SEC.-9364

1.862 Kg/Mtr.

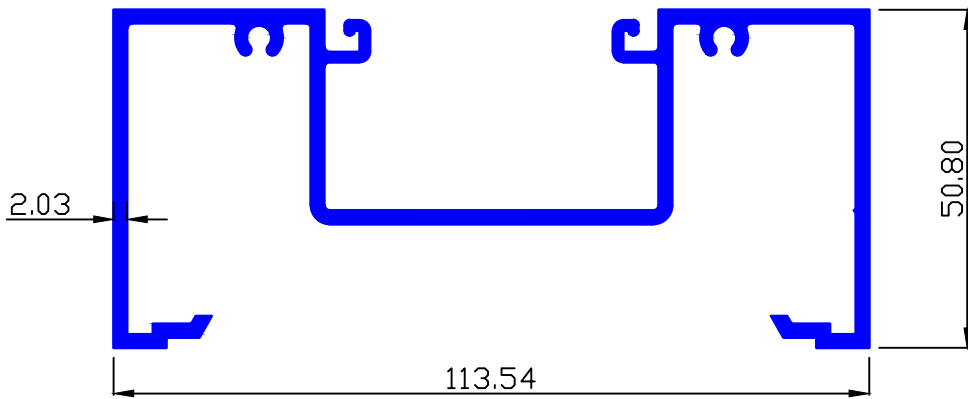

MAAN SEC.-9254

0.632 Kg/Mtr.

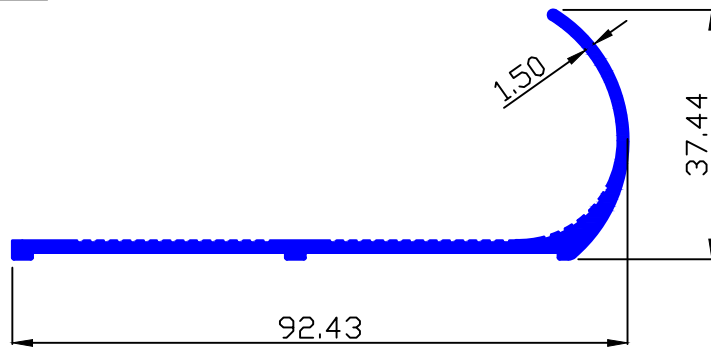



ARCHITECTURAL MISCELLANEOUS

MAAN SEC.-9367

0.670 Kg/Mtr.

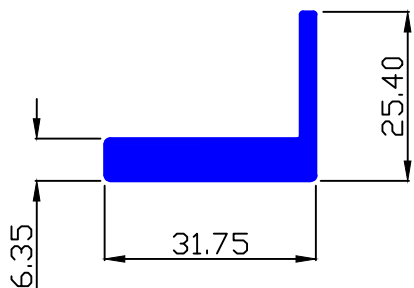

MAAN SEC.-9368

1.308 Kg/Mtr.

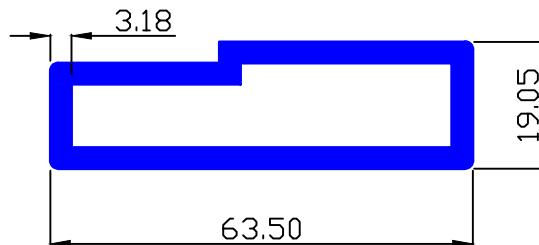

MAAN SEC.-9369

0.902 Kg/Mtr.

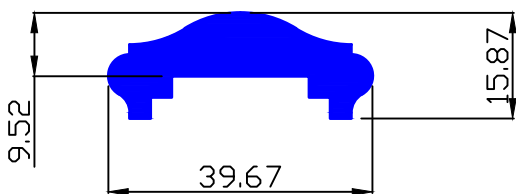

MAAN SEC.-9370

0.147 Kg/Mtr.

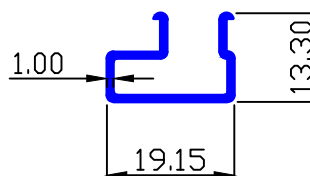

MAAN SEC.-9371

0.603 Kg/Mtr.

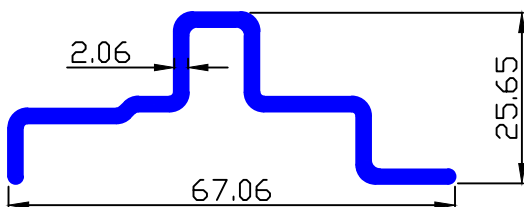

MAAN SEC.-9373

0.598 Kg/Mtr.

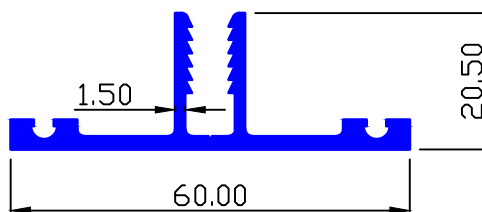

MAAN SEC.-9372

4.005 Kg/Mtr.

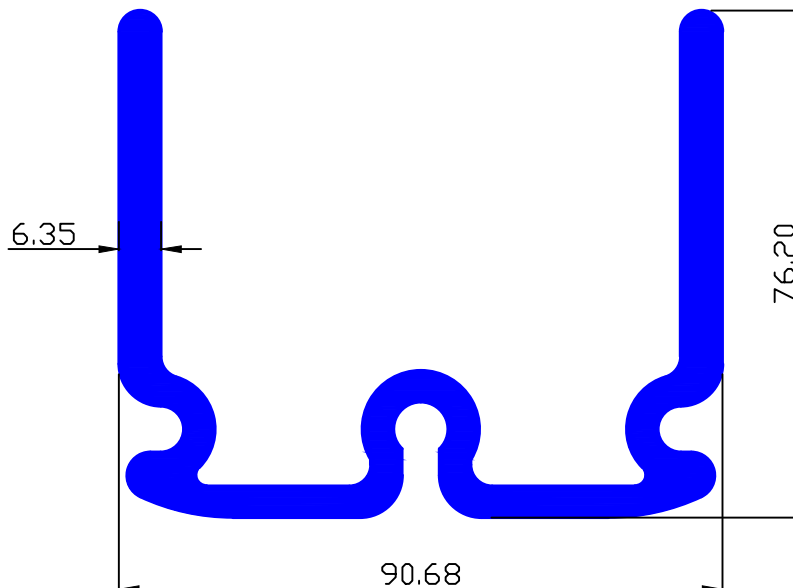



ARCHITECTURAL MISCELLANEOUS

MAAN SEC.-9255

0.394 Kg/Mtr.

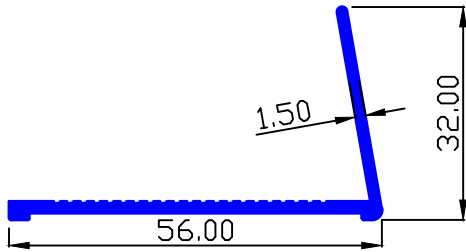

MAAN SEC.-9393

0.631 Kg/Mtr.

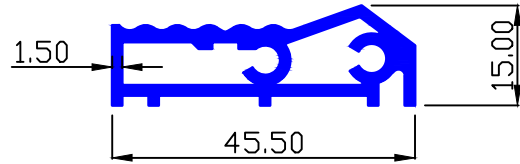

MAAN SEC.-9375

0.405 Kg/Mtr.

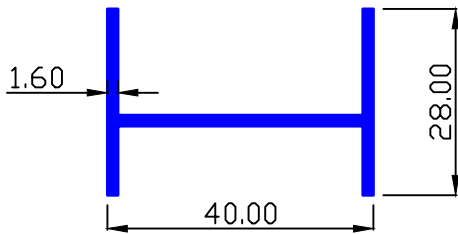

MAAN SEC.-9394

0.785 Kg/Mtr.

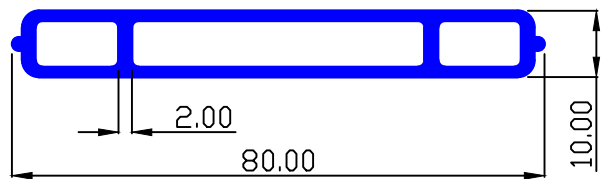

MAAN SEC.-9377

0.133 Kg/Mtr.

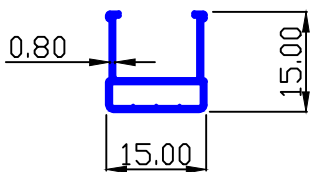

MAAN SEC.-9395

0.519 Kg/Mtr.

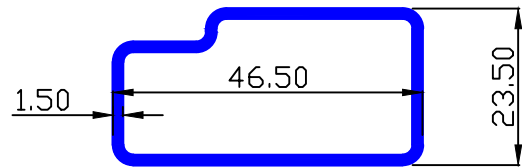

MAAN SEC.-9392

0.504 Kg/Mtr.

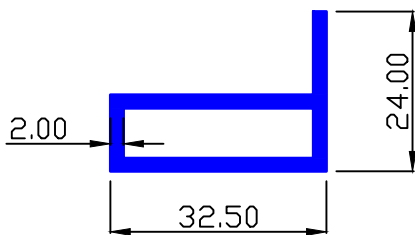

MAAN SEC.-9397

1.521 Kg/Mtr.

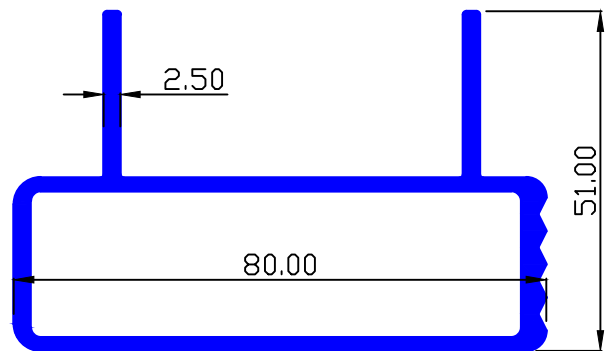

MAAN SEC.-9398

0.963 Kg/Mtr.

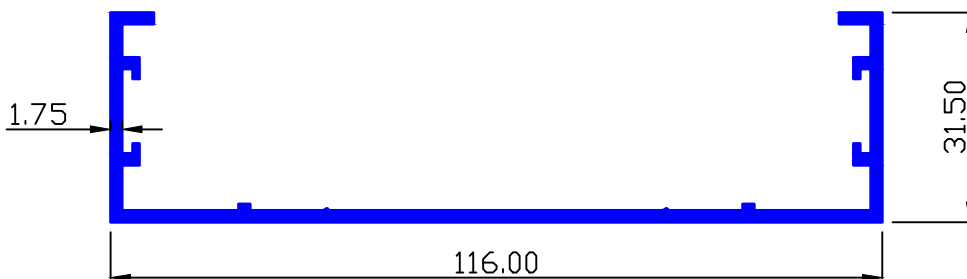



ARCHITECTURAL MISCELLANEOUS

MAAN SEC.-9399

0.826 Kg/Mtr.

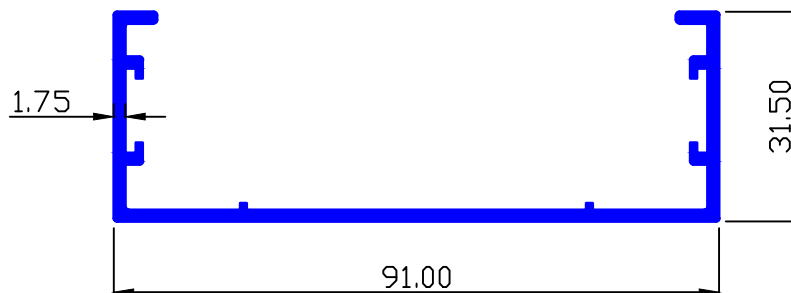

MAAN SEC.-9400

0.518 Kg/Mtr.

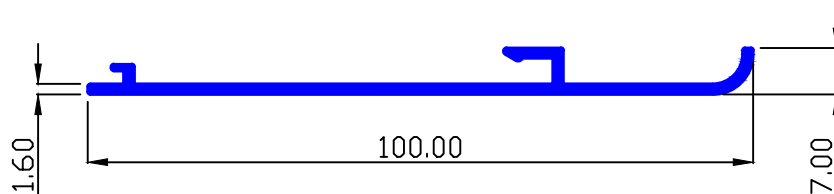

MAAN SEC.-9401

1.023 Kg/Mtr.

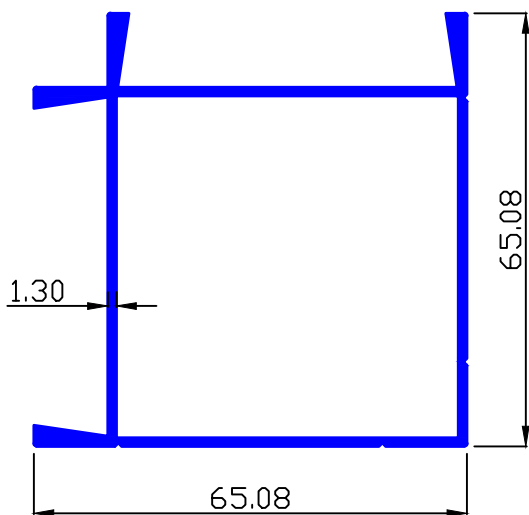

MAAN SEC.-9403

0.993 Kg/Mtr.

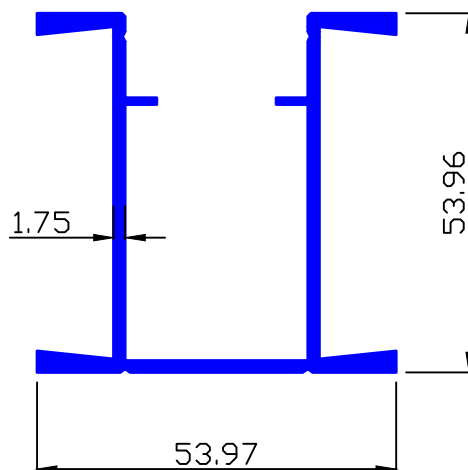

MAAN SEC.-9402

0.211 Kg/Mtr.

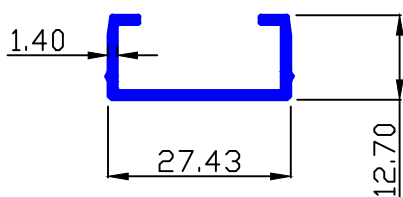

MAAN SEC.-9404

0.311 Kg/Mtr.

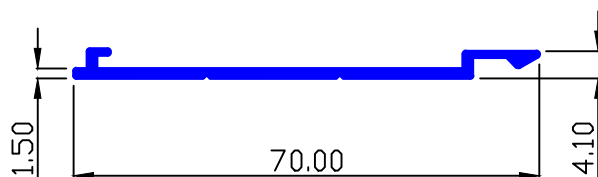



ARCHITECTURAL MISCELLANEOUS

MAAN SEC.-9412

1.186 Kg/Mtr.

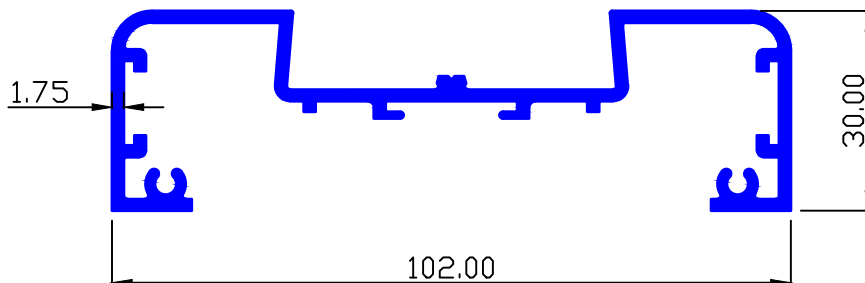

MAAN SEC.-9413

1.413 Kg/Mtr.

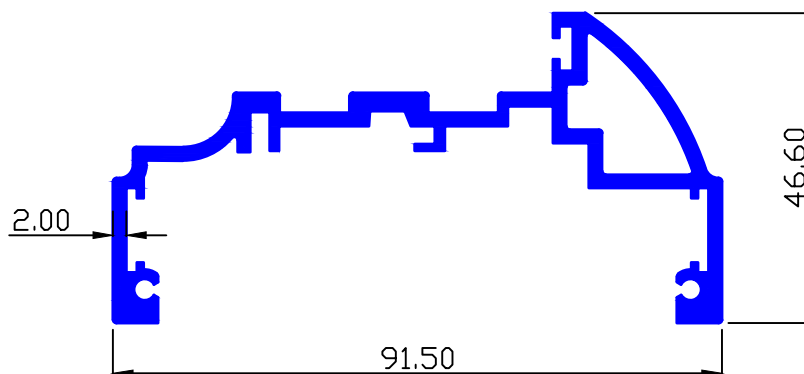

MAAN SEC.-9411

1.068 Kg/Mtr.

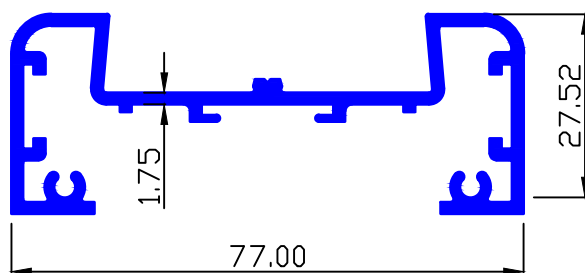

MAAN SEC.-9415

0.377 Kg/Mtr.

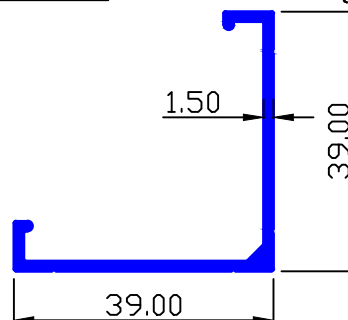

MAAN SEC.-9416

0.249 Kg/Mtr.

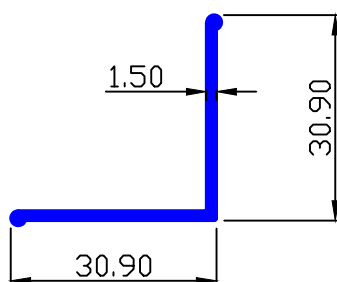

MAAN SEC.-9417

0.780 Kg/Mtr.

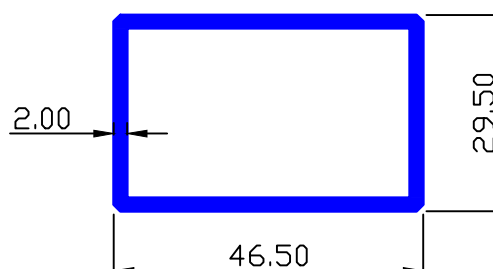



ARCHITECTURAL MISCELLANEOUS

MAAN SEC.-9418

2.161 Kg/Mtr.

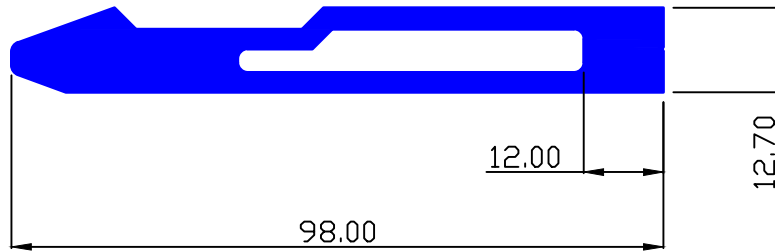

MAAN SEC.-9419

1.629 Kg/Mtr.

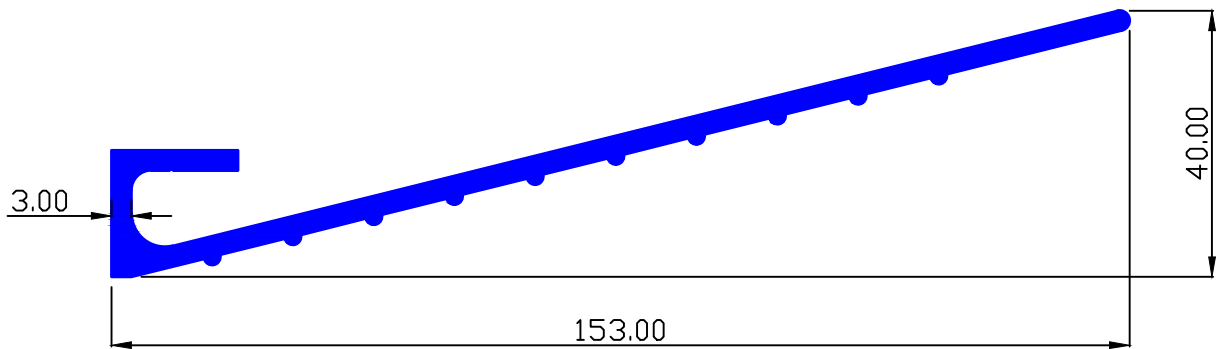

MAAN SEC.-9420

0.168 Kg/Mtr.

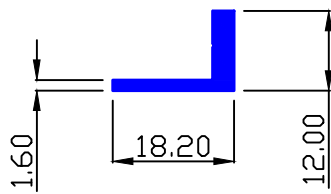

MAAN SEC.-9421

1.629 Kg/Mtr.

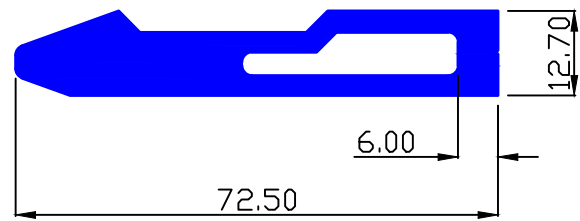

MAAN SEC.-9423

1.114 Kg/Mtr.

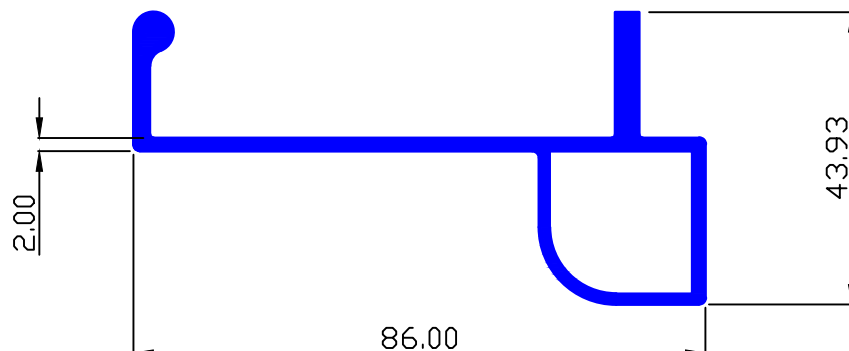



ARCHITECTURAL MISCELLANEOUS

MAAN SEC.-9424

1.009 Kg/Mtr.

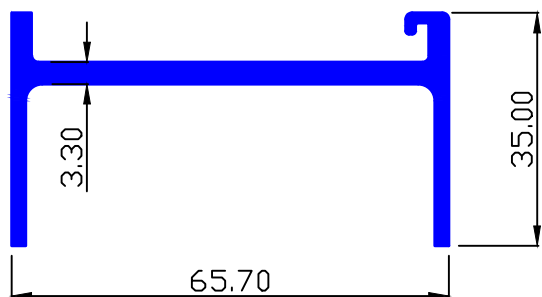

MAAN SEC.-9430

0.787 Kg/Mtr.

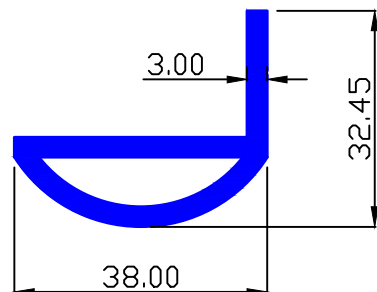

MAAN SEC.-9425

0.500 Kg/Mtr.

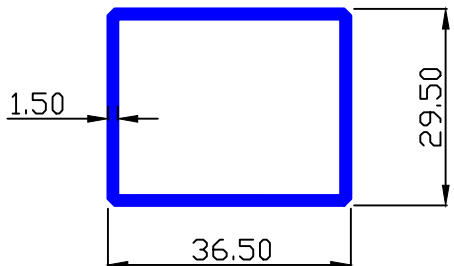

MAAN SEC.-9431

0.287 Kg/Mtr.

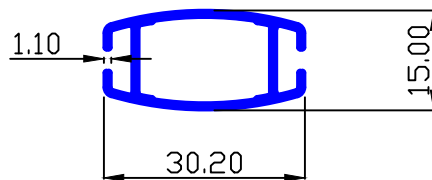

MAAN SEC.-9426

0.469 Kg/Mtr.

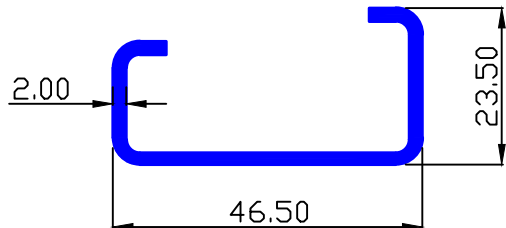

MAAN SEC.-9405

0.597 Kg/Mtr.

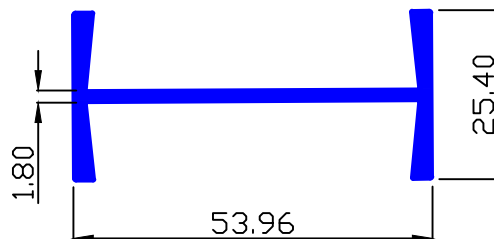

MAAN SEC.-9427

0.247 Kg/Mtr.

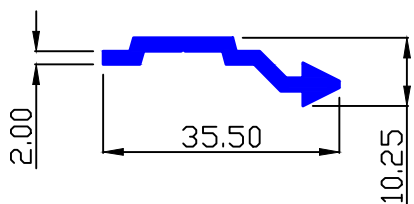

MAAN SEC.-9455

0.251 Kg/Mtr.

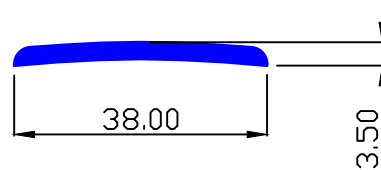

MAAN SEC.-9459

0.157 Kg/Mtr.

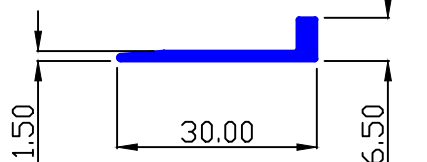

MAAN SEC.-9456

0.367 Kg/Mtr.

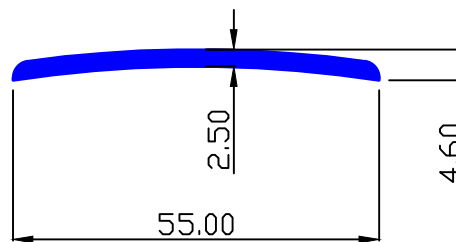



ARCHITECTURAL MISCELLANEOUS

MAAN SEC.-9457

0.697 Kg/Mtr.

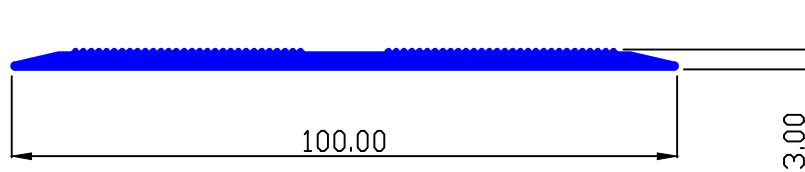

MAAN SEC.-9458

0.261 Kg/Mtr.

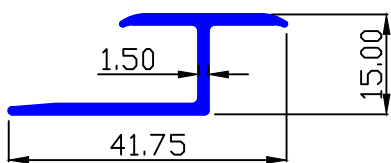

MAAN SEC.-9463

0.257 Kg/Mtr.

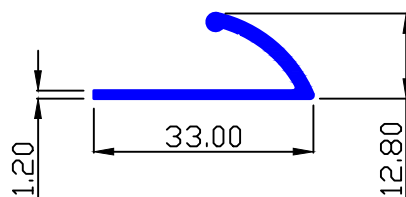

MAAN SEC.-9459

0.157 Kg/Mtr.

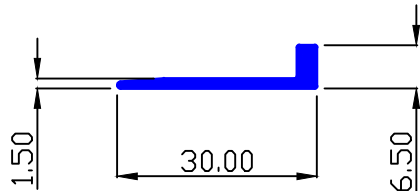

MAAN SEC.-9464

0.211 Kg/Mtr.

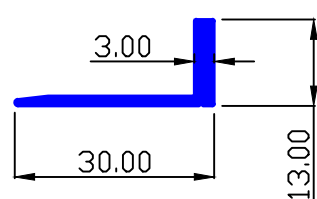

MAAN SEC.-9460

0.178 Kg/Mtr.

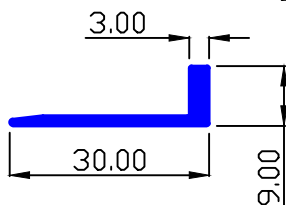

MAAN SEC.-9465

0.235 Kg/Mtr.

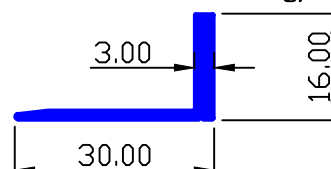

MAAN SEC.-9461

0.257 Kg/Mtr.

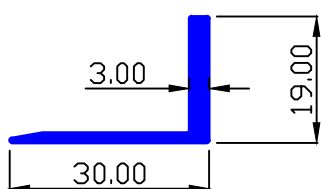

MAAN SEC.-9466

0.254 Kg/Mtr.

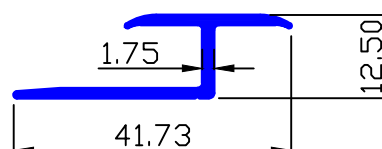

MAAN SEC.-9462

0.367 Kg/Mtr.

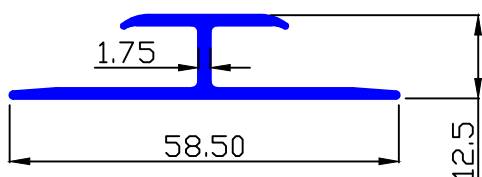

MAAN SEC.-9467

0.300 Kg/Mtr.

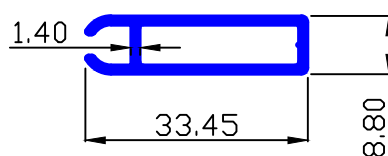



ARCHITECTURAL MISCELLANEOUS

MAAN SEC.-9468

0.524 Kg/Mtr.

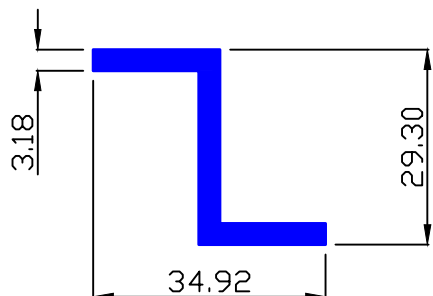

MAAN SEC.-9472

0.840 Kg/Mtr.

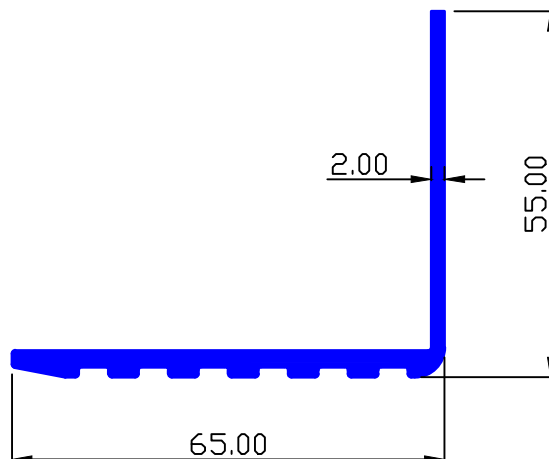

MAAN SEC.-9469

0.125 Kg/Mtr.

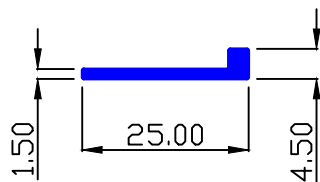

MAAN SEC.-9473

0.568 Kg/Mtr.

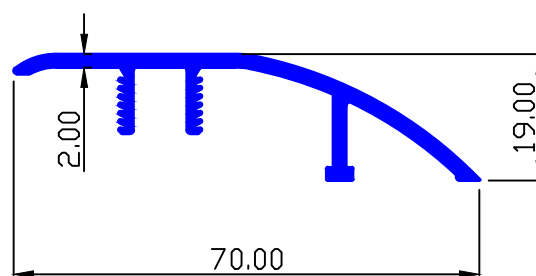

MAAN SEC.-9470

0.161 Kg/Mtr.

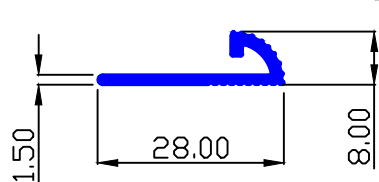

MAAN SEC.-9414

0.121 Kg/Mtr.

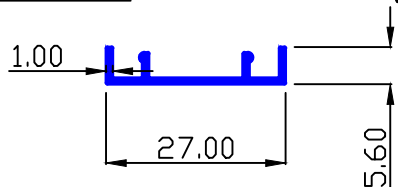

MAAN SEC.-9408

0.849 Kg/Mtr.

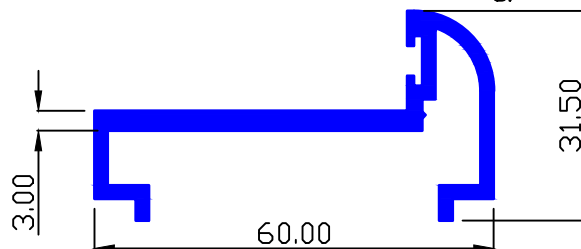

MAAN SEC.-9410

1.582 Kg/Mtr.

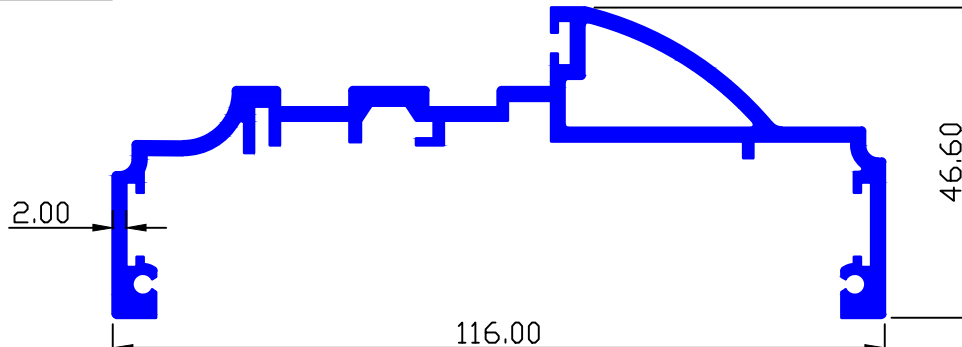



ARCHITECTURAL MISCELLANEOUS

MAAN SEC.-89279

0.259 Kg/Mtr.

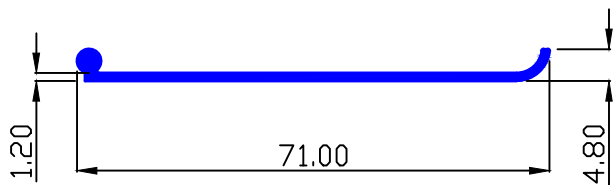

MAAN SEC.-89314

0.233 Kg/Mtr.

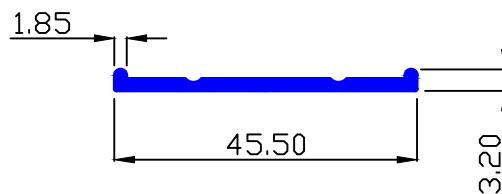

MAAN SEC.-6948

0.607 Kg/Mtr.

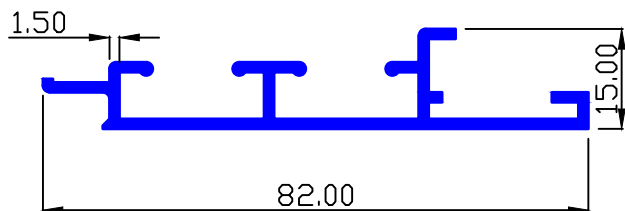

MAAN SEC.-6930

0.150 Kg/Mtr.

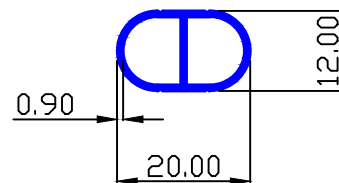

MAAN SEC.-89570

1.471 Kg/Mtr.

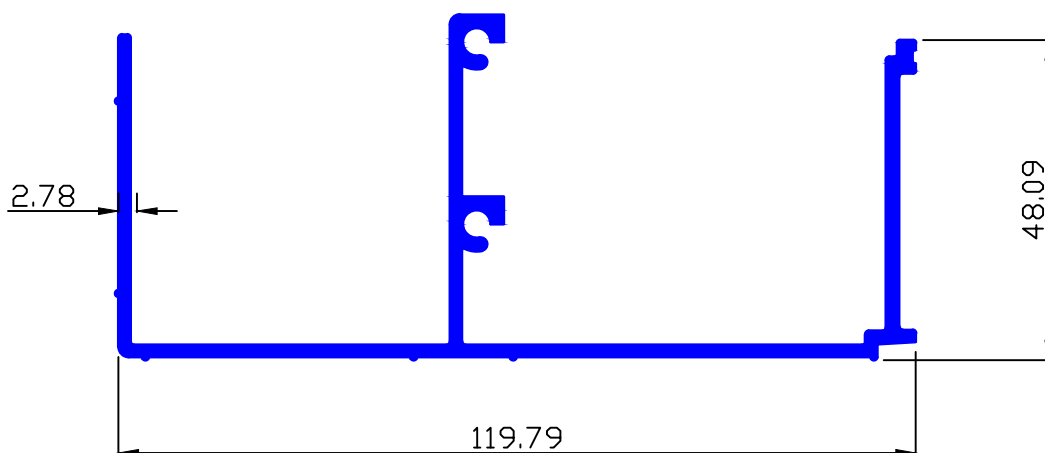



ARCHITECTURAL MISCELLANEOUS

MAAN SEC.-89805

0.937 Kg/Mtr.

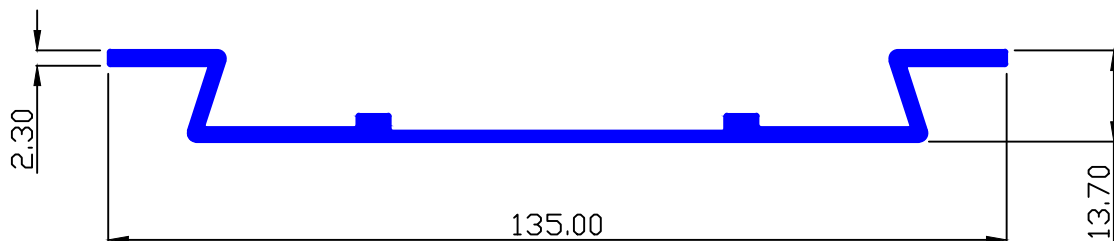

MAAN SEC.-89627

0.910 Kg/Mtr.

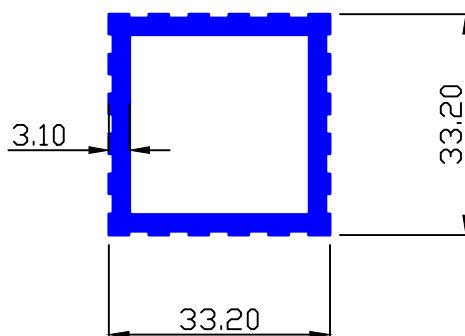

MAAN SEC.-89251

2.607 Kg/Mtr.

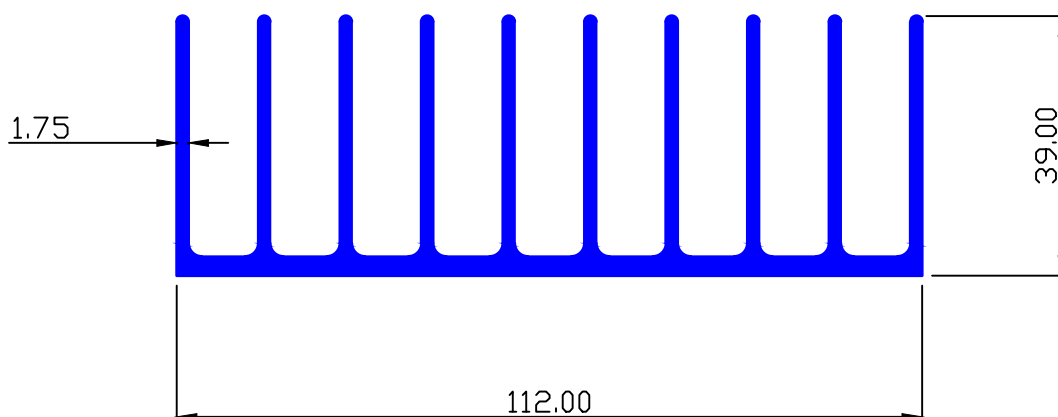



ARCHITECTURAL MISCELLANEOUS

MAAN SEC.-6784

0.400 Kg/Mtr.

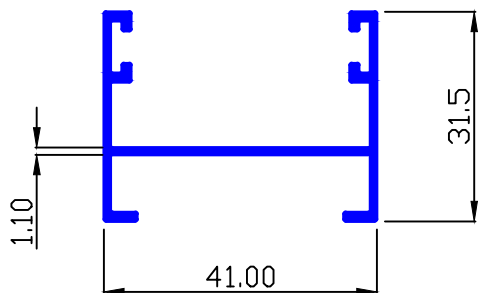

MAAN SEC.-9170

0.339 Kg/Mtr.

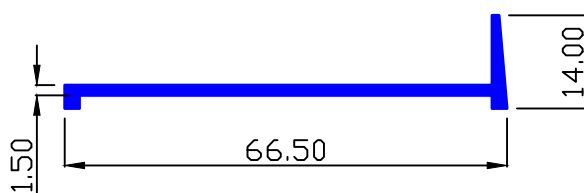

MAAN SEC.-6785

1.597 Kg/Mtr.

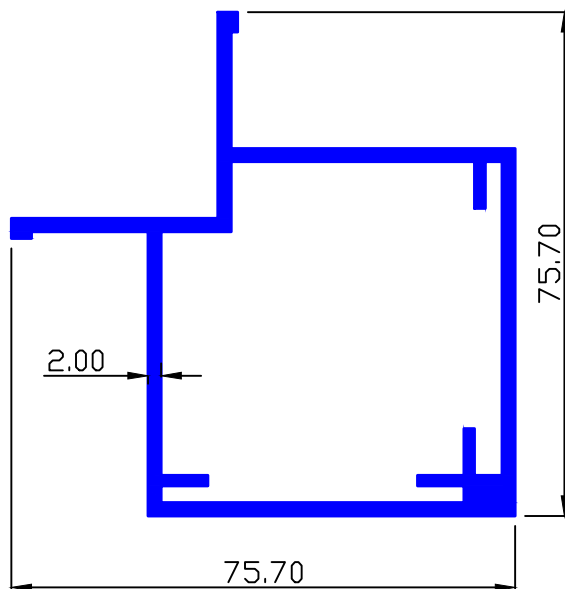

MAAN SEC.-6836

0.394 Kg/Mtr.

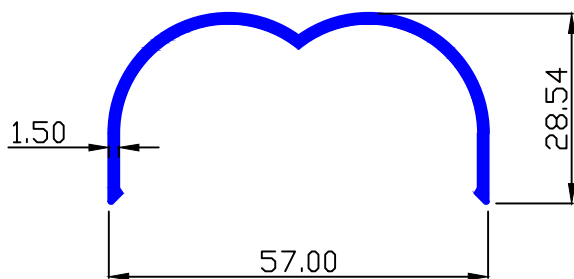

MAAN SEC.-6837

0.253 Kg/Mtr.

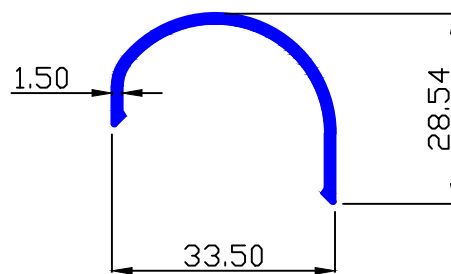

MAAN SEC.-6956

0.788 Kg/Mtr.

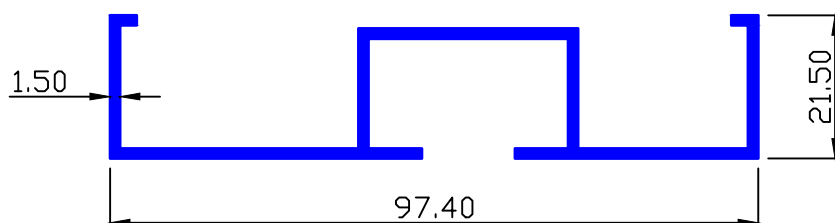



ARCHITECTURAL MISCELLANEOUS

MAAN SEC.-7006

3.050 Kg/Mtr.

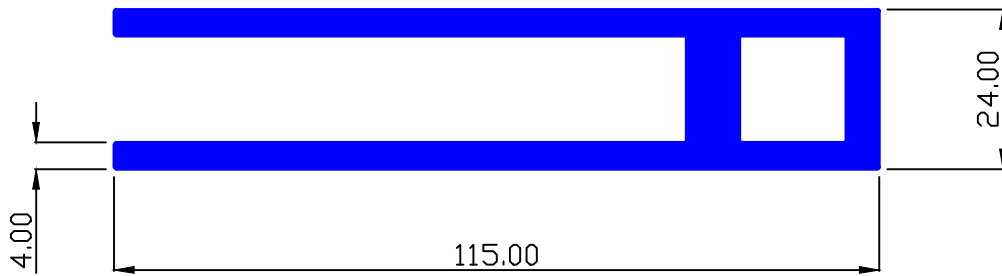

MAAN SEC.-6848

1.700 Kg/Mtr.

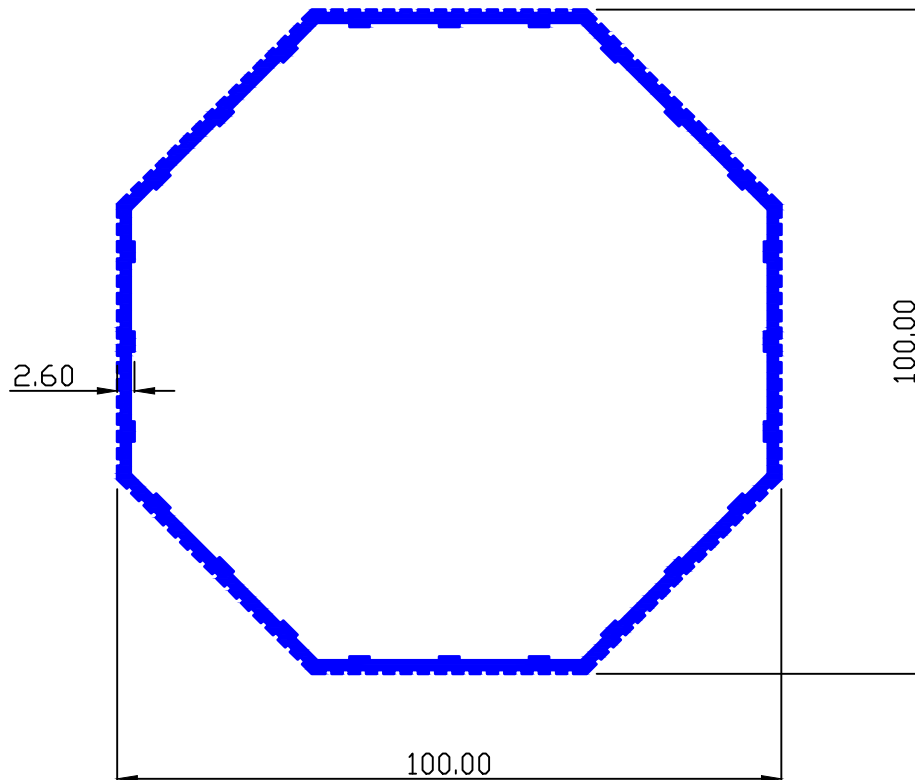



ARCHITECTURAL MISCELLANEOUS

MAAN SEC.-6853

1.440 Kg/Mtr.

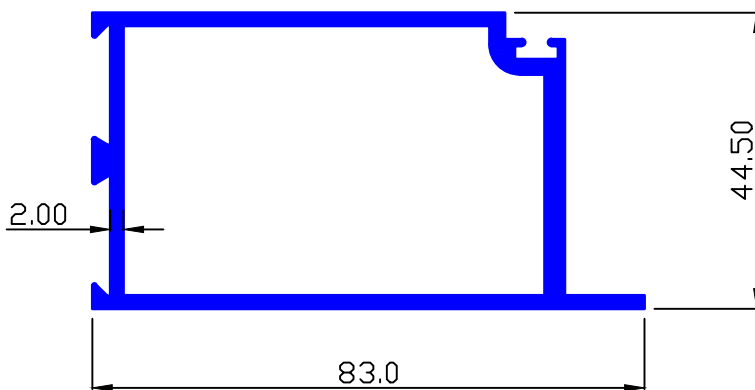

MAAN SEC.-6857

1.254 Kg/Mtr.

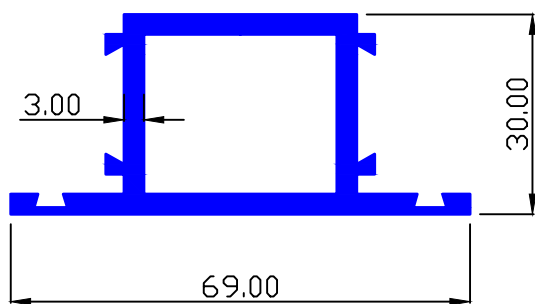

MAAN SEC.-9405

0.597 Kg/Mtr.

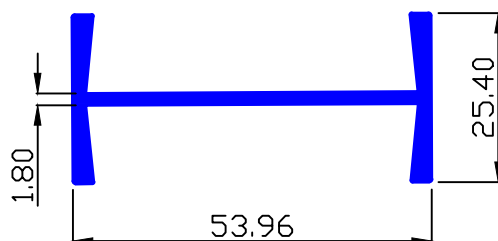

MAAN SEC.-6926

0.125 Kg/Mtr.

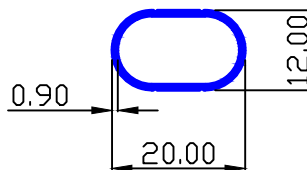

MAAN SEC.-6858

1.658 Kg/Mtr.

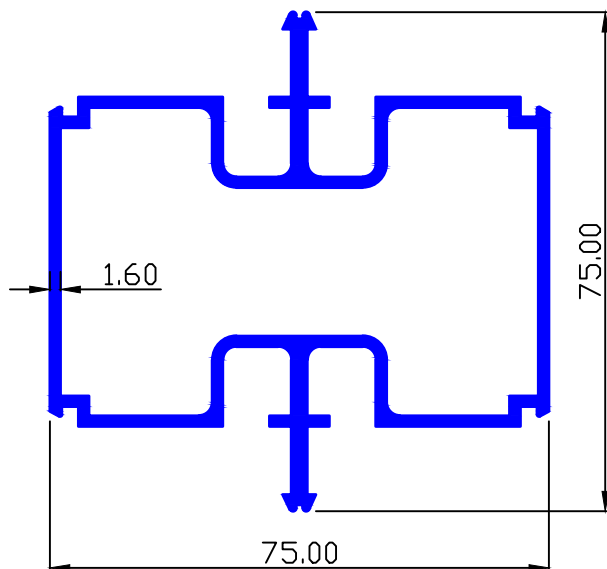

MAAN SEC.-6927

0.240 Kg/Mtr.

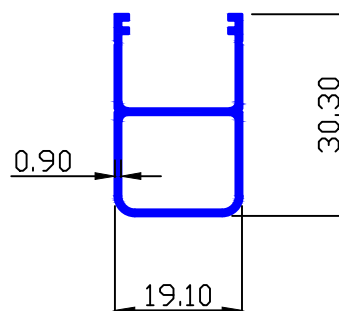



ARCHITECTURAL MISCELLANEOUS

MAAN SEC.-6961

0.988 Kg/Mtr.

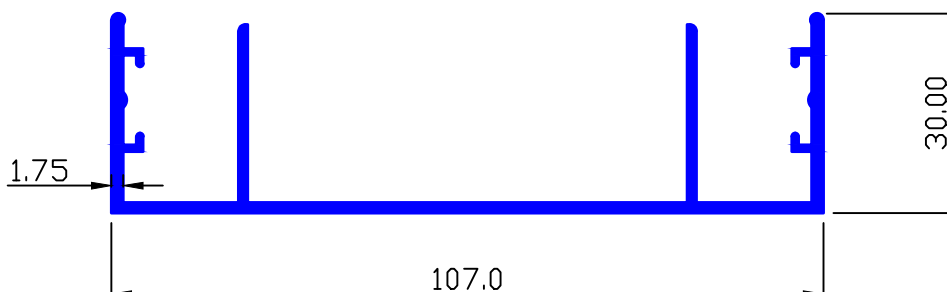

MAAN SEC.-6962

0.378 Kg/Mtr.

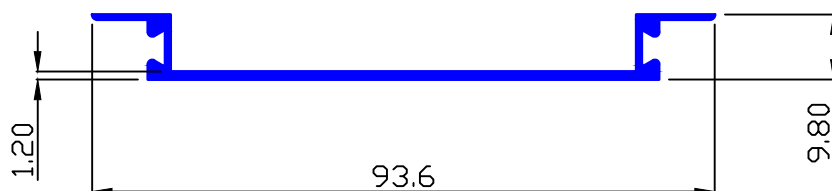

MAAN SEC.-7001

0.925 Kg/Mtr.

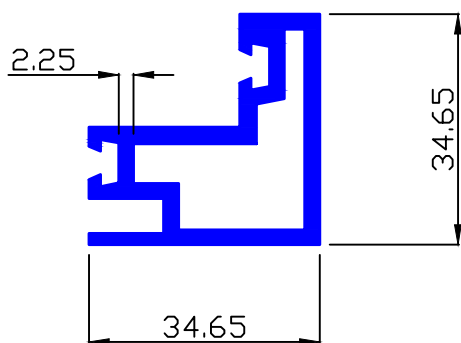

MAAN SEC.-7005

0.615 Kg/Mtr.

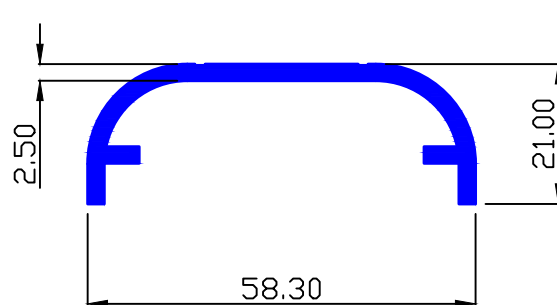

MAAN SEC.-7004

0.346 Kg/Mtr.

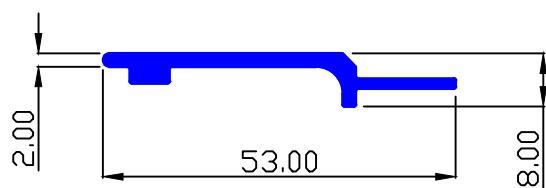

MAAN SEC.-7008

0.346 Kg/Mtr.

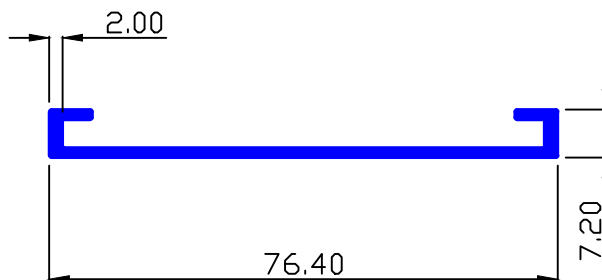



ARCHITECTURAL MISCELLANEOUS

MAAN SEC.-6838

0.647 Kg/Mtr.

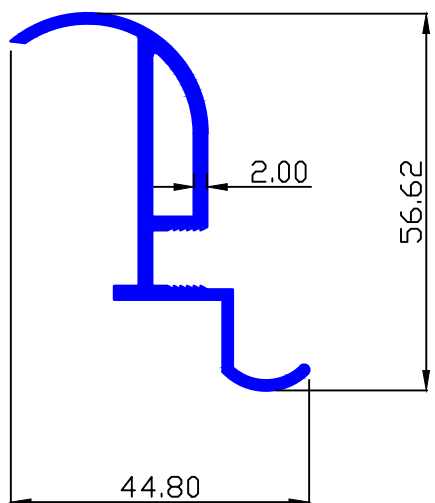

MAAN SEC.-9171

0.323 Kg/Mtr.

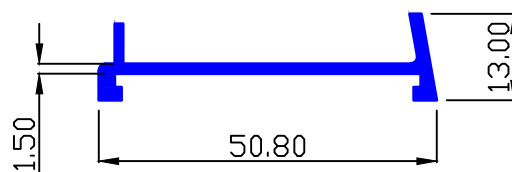

MAAN SEC.-7046

0.376 Kg/Mtr.

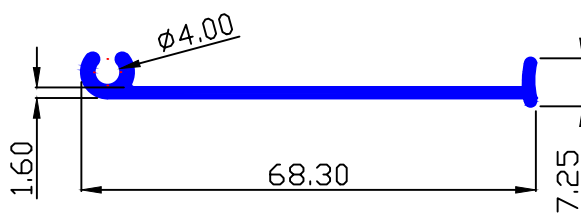

MAAN SEC.-7039

0.538 Kg/Mtr.

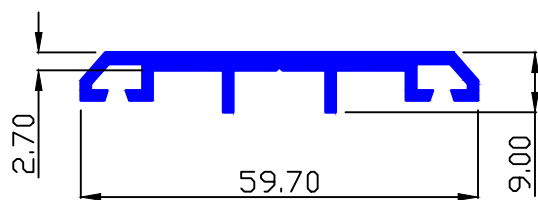

MAAN SEC.-7055

1.447 Kg/Mtr.

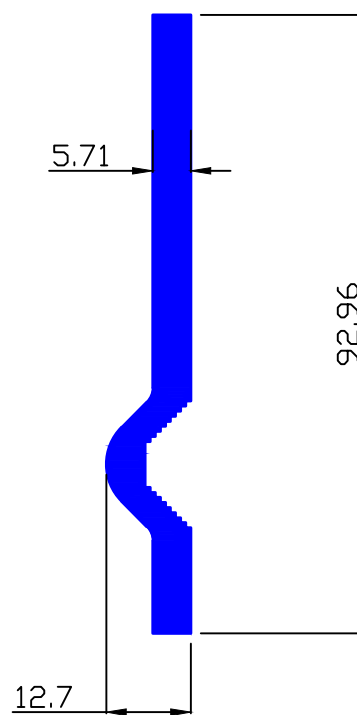

MAAN SEC.-7042

3.438 Kg/Mtr.

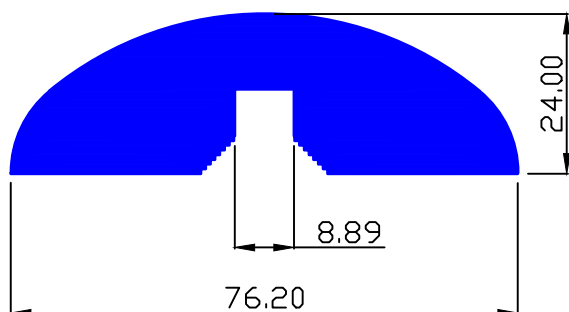



ARCHITECTURAL MISCELLANEOUS

MAAN SEC.-7056

1.918 Kg/Mtr.

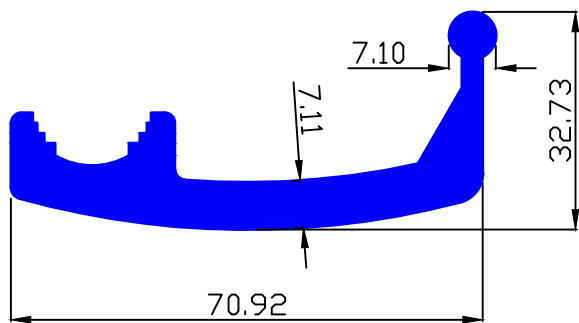

MAAN SEC.-7092

0.465 Kg/Mtr.

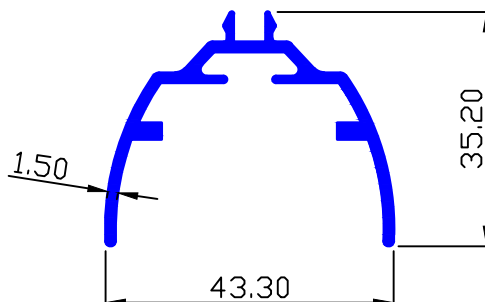

MAAN SEC.-7084

0.426 Kg/Mtr.

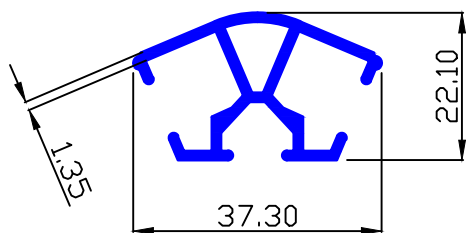

MAAN SEC.-8072

1.839 Kg/Mtr.

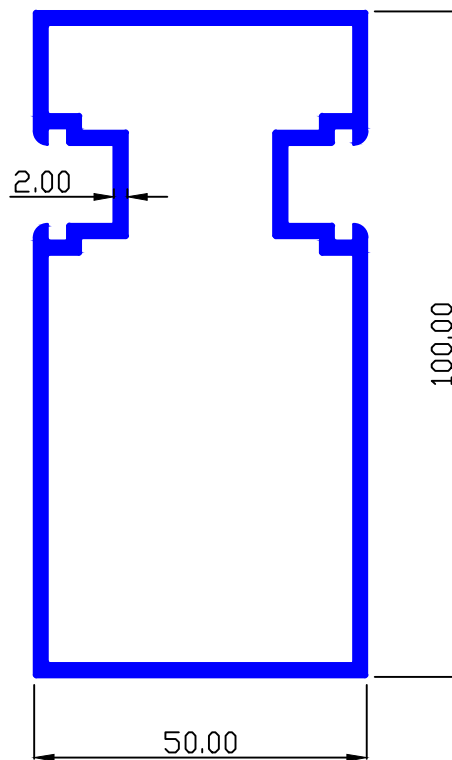

MAAN SEC.-7085

1.159 Kg/Mtr.

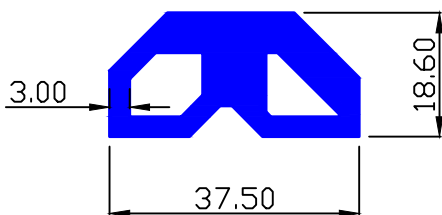

MAAN SEC.-7087

1.935 Kg/Mtr.

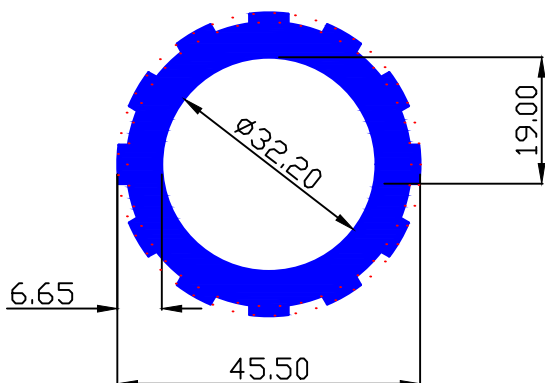

MAAN SEC.-9107

0.297 Kg/Mtr.

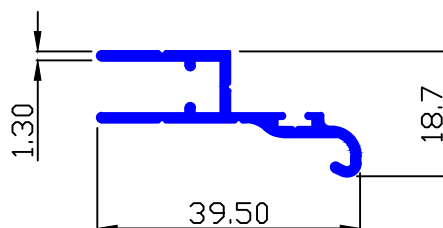



ARCHITECTURAL MISCELLANEOUS

MAAN SEC.-9108

0.351 Kg/Mtr.

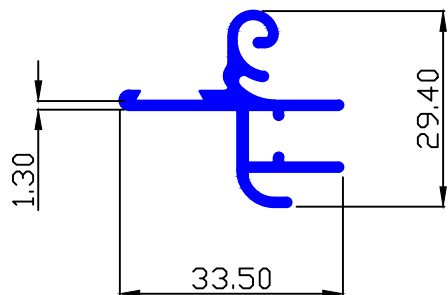

MAAN SEC.-9129

0.716 Kg/Mtr.

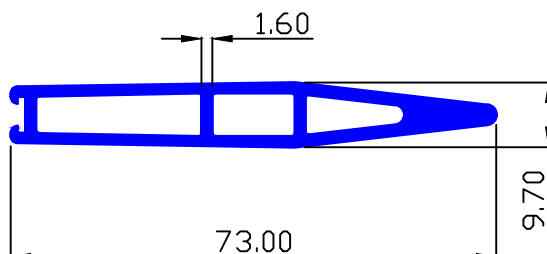

MAAN SEC.-9109

1.851 Kg/Mtr.

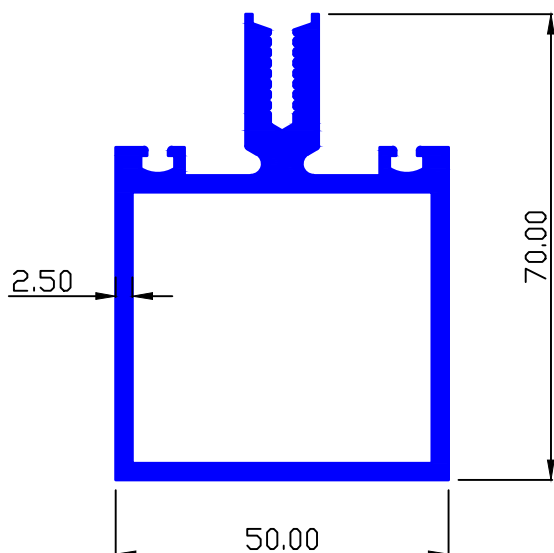

MAAN SEC.-9131

0.933 Kg/Mtr.

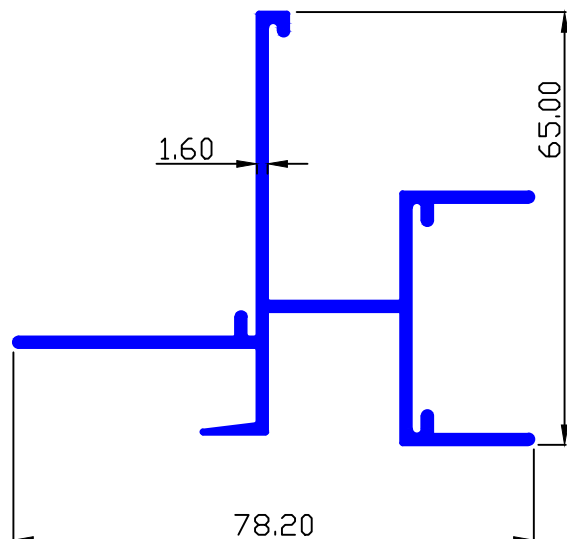

MAAN SEC.-9219

0.638 Kg/Mtr.

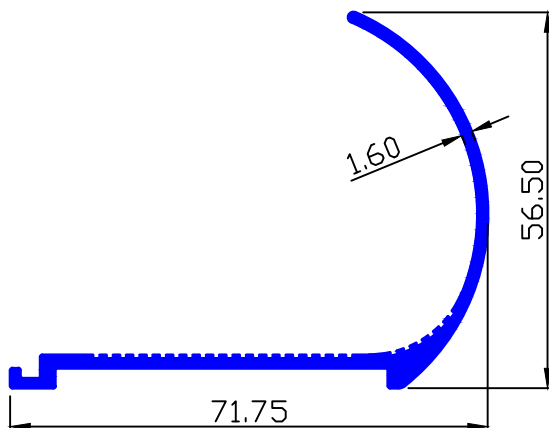



ARCHITECTURAL MISCELLANEOUS

MAAN SEC.-9132

0.180 Kg/Mtr.

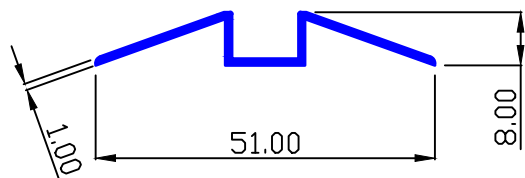

MAAN SEC.-9142

0.314 Kg/Mtr.

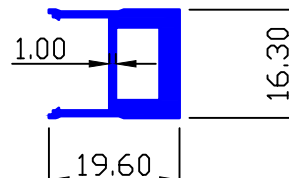

MAAN SEC.-9133

0.137 Kg/Mtr.

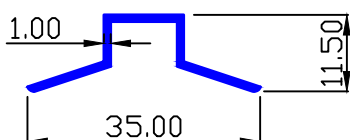

MAAN SEC.-9143

0.312 Kg/Mtr.

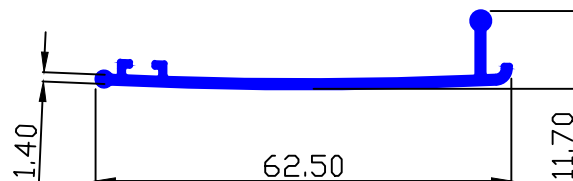

MAAN SEC.-9134

0.113 Kg/Mtr.

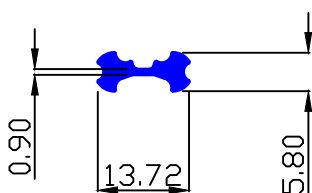

MAAN SEC.-9144

0.283 Kg/Mtr.

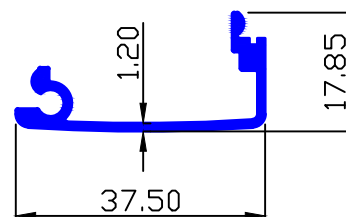

MAAN SEC.-9138

0.171 Kg/Mtr.

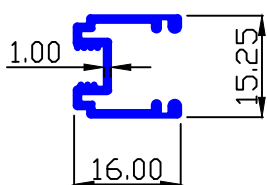

MAAN SEC.-9269

0.463 Kg/Mtr.

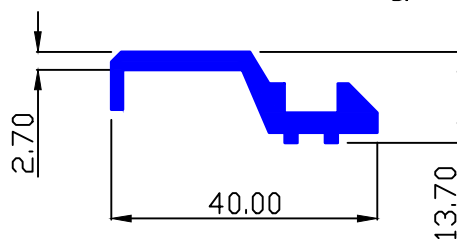

MAAN SEC.-9140

0.531 Kg/Mtr.

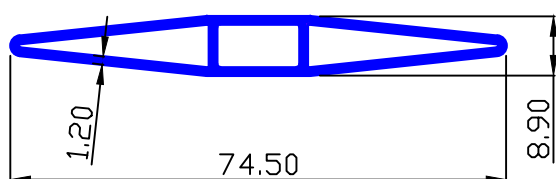

MAAN SEC.-9146

0.206 Kg/Mtr.

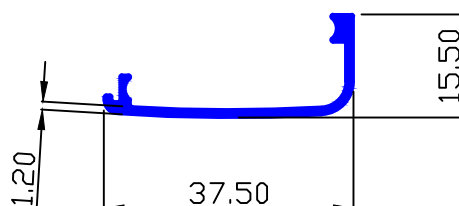



ARCHITECTURAL MISCELLANEOUS

MAAN SEC.-9152

0.166 Kg/Mtr.

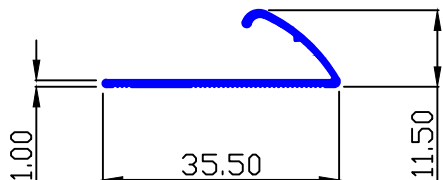

MAAN SEC.-9162

0.592 Kg/Mtr.

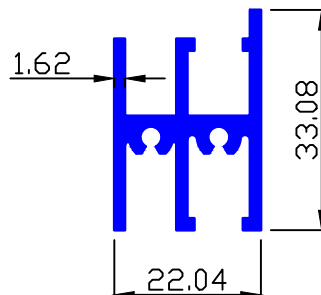

MAAN SEC.-9376

1.797 Kg/Mtr.

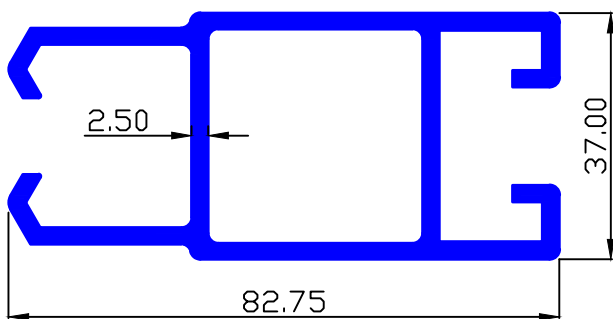

MAAN SEC.-9163

0.657 Kg/Mtr.

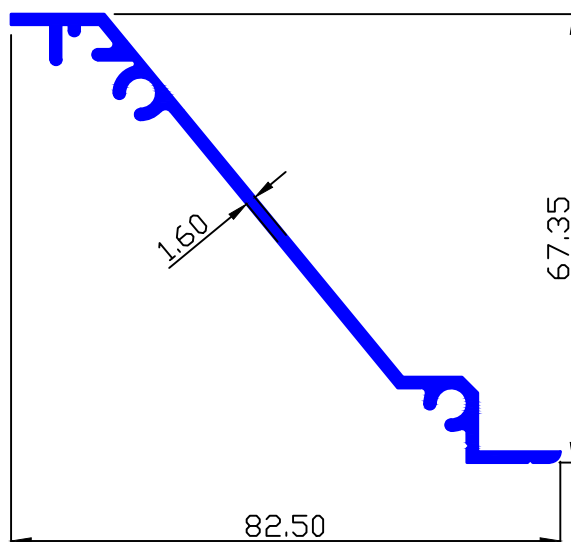

MAAN SEC.-9161

0.445 Kg/Mtr.

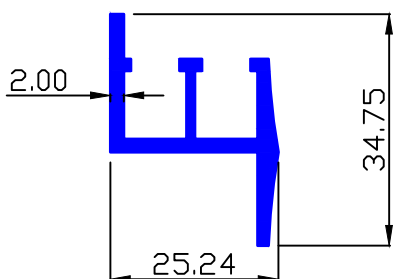

MAAN SEC.-9165

2.292 Kg/Mtr.

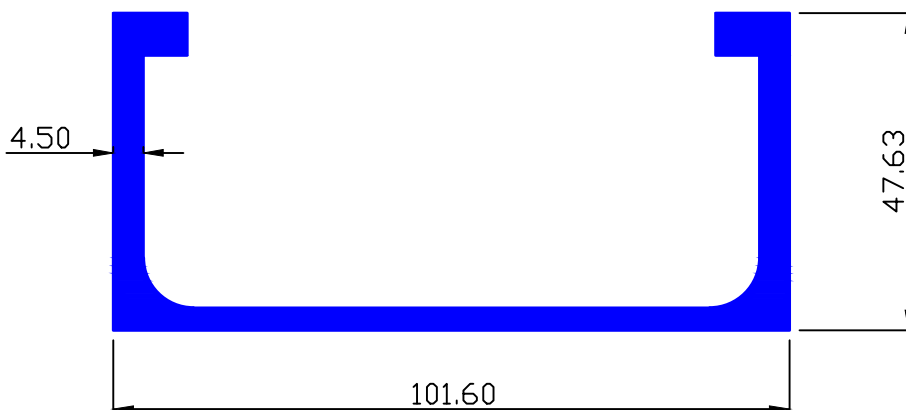



ARCHITECTURAL MISCELLANEOUS

MAAN SEC.-9232

0.796 Kg/Mtr.

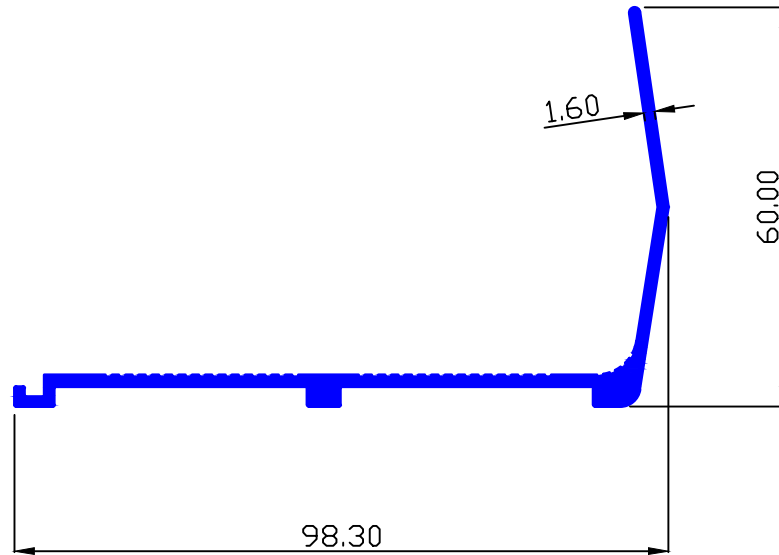

MAAN SEC.-9260

0.843 Kg/Mtr.

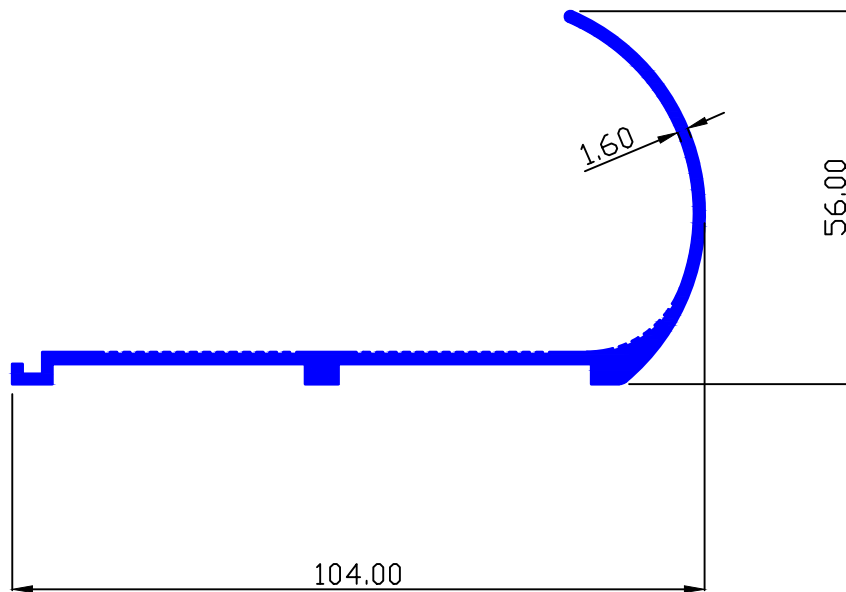



MISCELLANEOUS  
ARCHITECTURAL

MAAN SEC.-90338

4.065 Kg/Mtr.

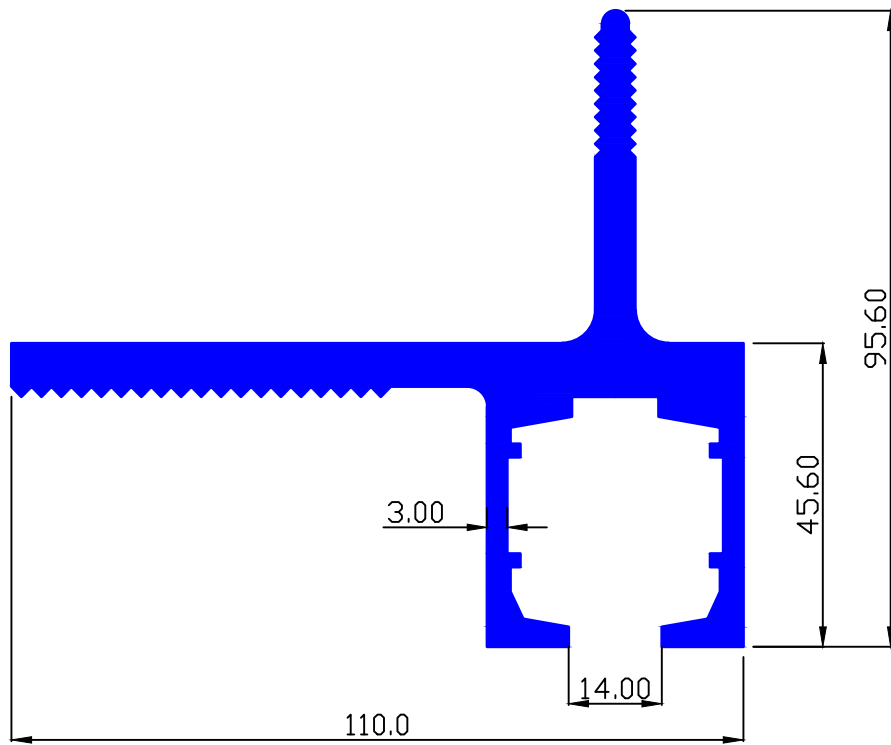

MAAN SEC.-90346

2.450 Kg/Mtr.

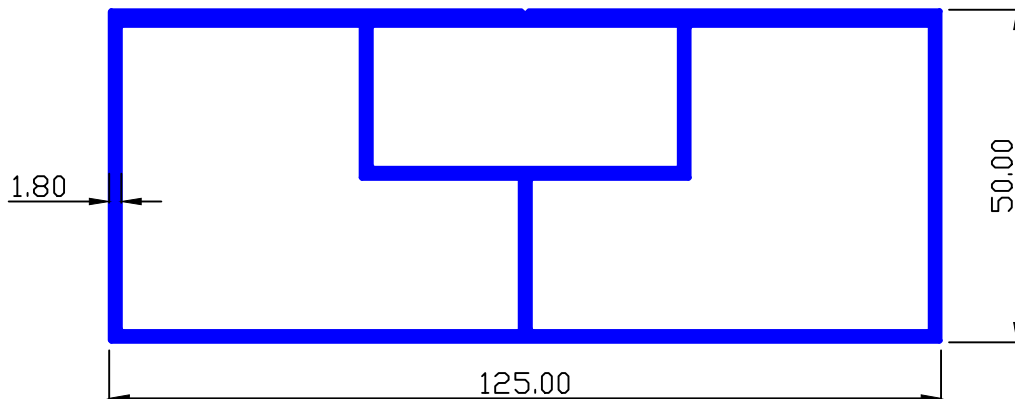

MISCELLANEOUS  
ARCHITECTURAL

MAAN SEC.-90339

2.036 Kg/Mtr.

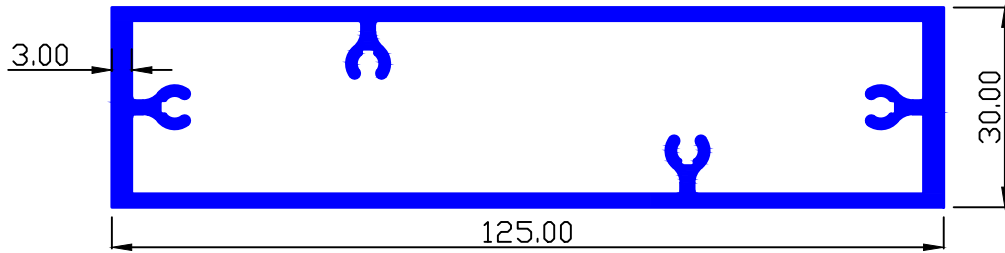

MAAN SEC.-90347

2.427 Kg/Mtr.

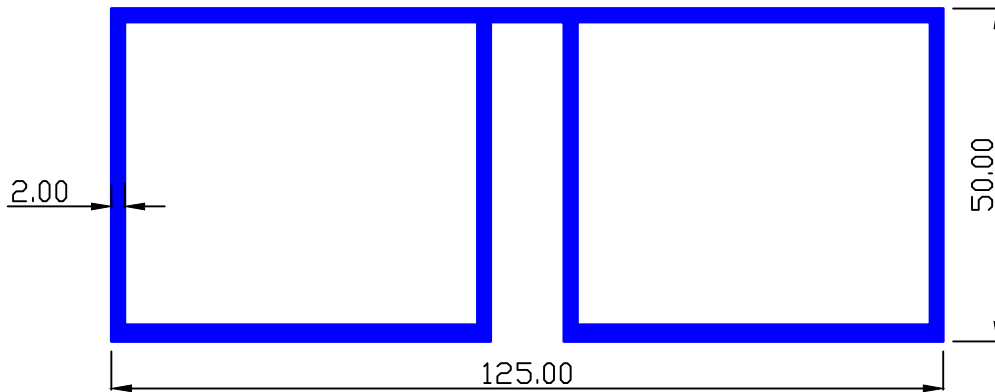

MAAN SEC.-90348

4.530 Kg/Mtr.

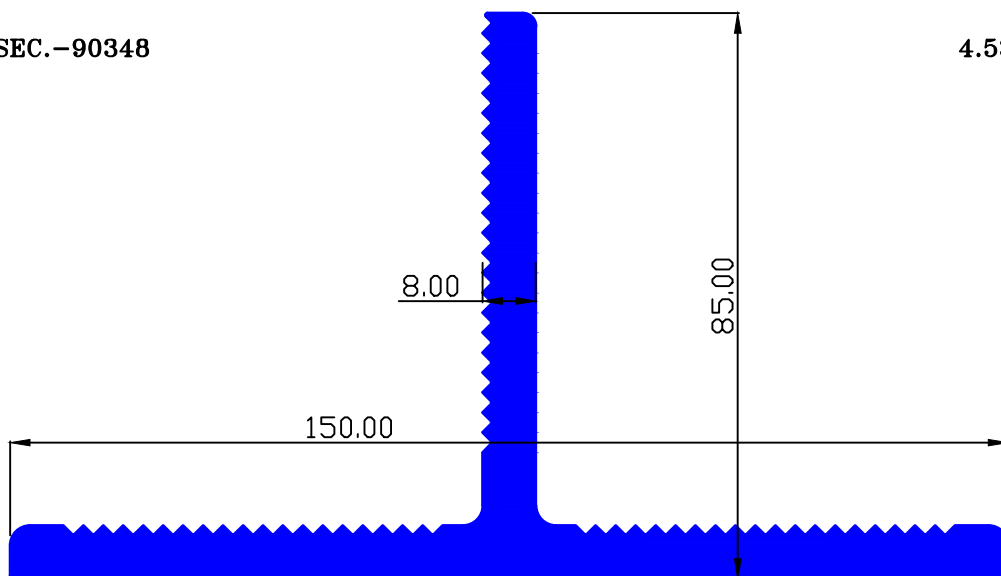



**MISCELLANEOUS  
ARCHITECTURAL**

**MAAN SEC.-90238**

**1.620 Kg/Mtr.**

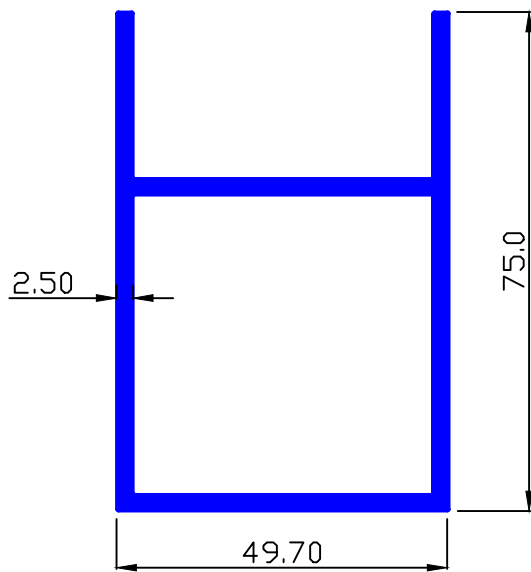

**MAAN SEC.-90165**

**3.445 Kg/Mtr.**

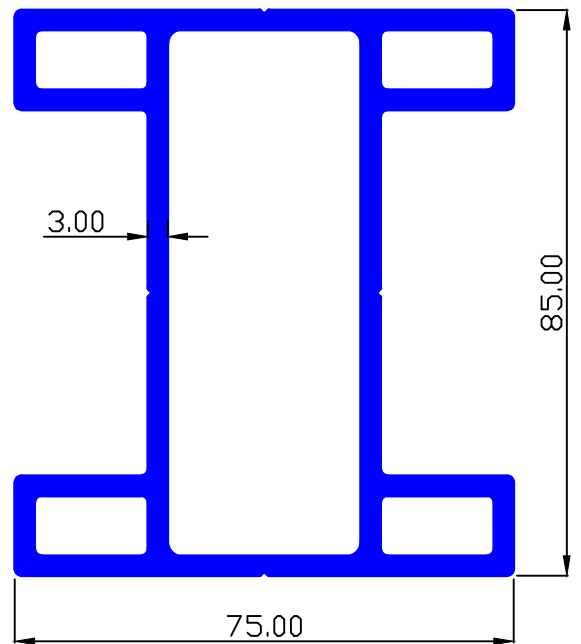

**MAAN SEC.-90206**

**1.135 Kg/Mtr.**

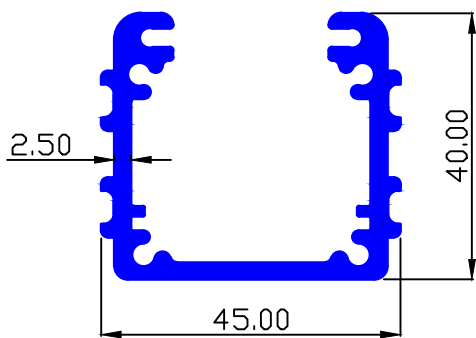

**MAAN SEC.-90135**

**0.682 Kg/Mtr.**

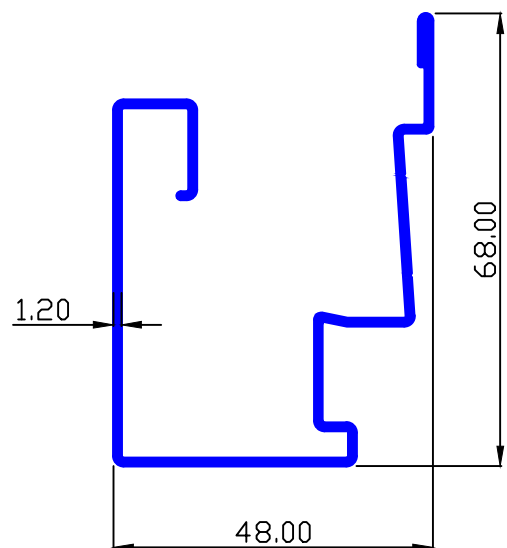

**MAAN SEC.-90164**

**0.843 Kg/Mtr.**

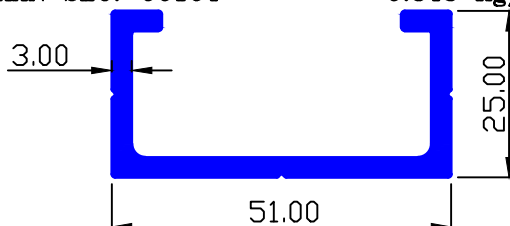



**MISCELLANEOUS  
ARCHITECTURAL**

MAAN SEC.-90134

0.520 Kg/Mtr.

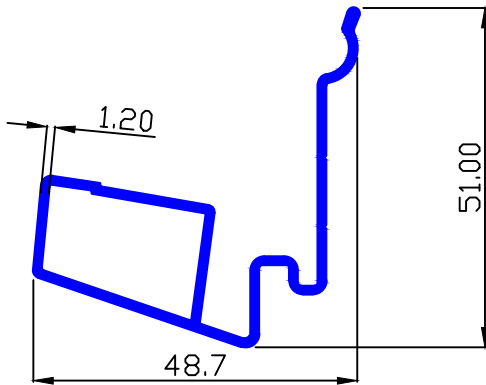

MAAN SEC.-89988

0.256 Kg/Mtr.

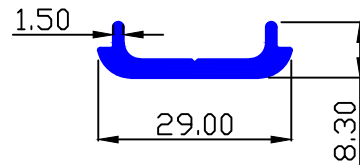

MAAN SEC.-90404

0.426 Kg/Mtr.

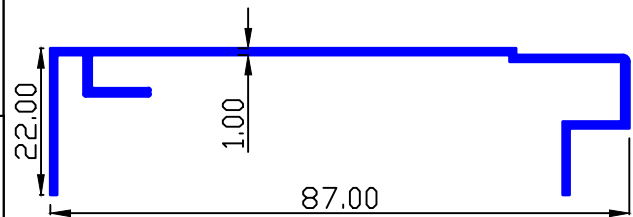

MAAN SEC.-90055

2.907 Kg/Mtr.

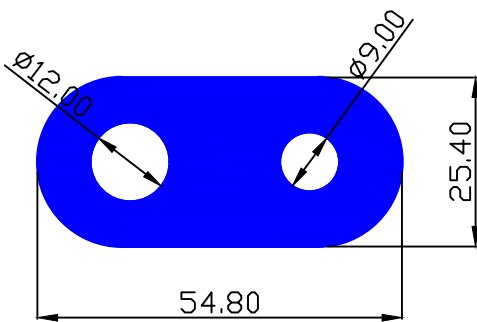

MAAN SEC.-90405

0.110 Kg/Mtr.

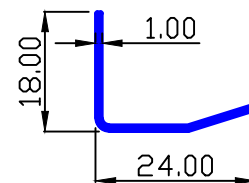

MAAN SEC.-90054

0.251 Kg/Mtr.

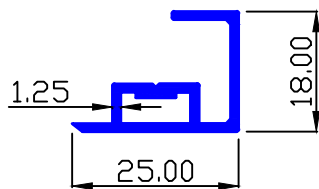

MAAN SEC.-90412

0.480 Kg/Mtr.

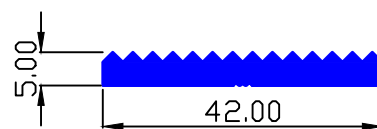

MAAN SEC.-90024

0.274 Kg/Mtr.

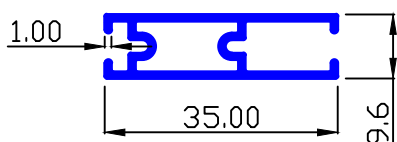

MAAN SEC.-90431

0.564 Kg/Mtr.

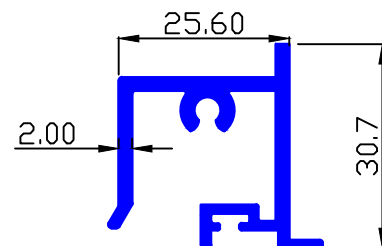



**MISCELLANEOUS  
ARCHITECTURAL**

**MAAN SEC.-90072**

**4.933 Kg/Mtr.**

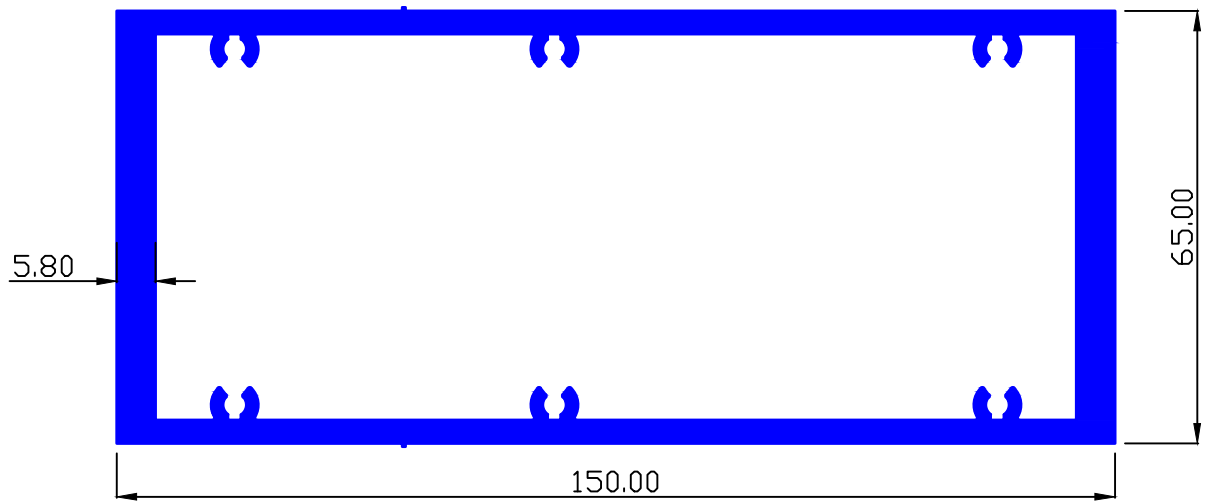

**MAAN SEC.-90071**

**3.863 Kg/Mtr.**

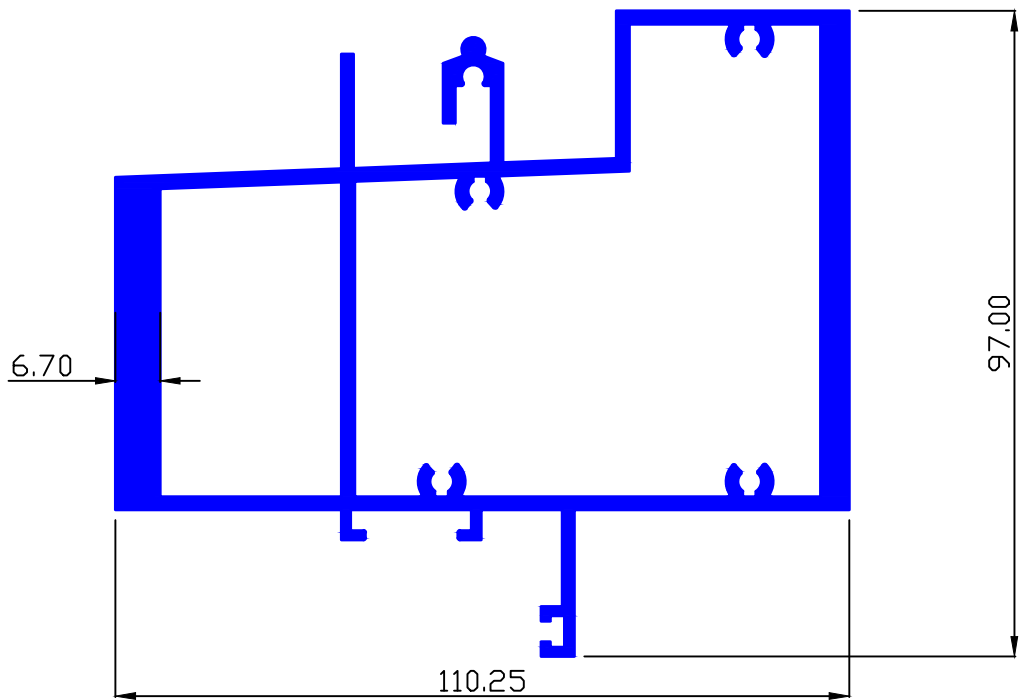



**MISCELLANEOUS  
ARCHITECTURAL**

**MAAN SEC.-90070**

**1.645 Kg/Mtr.**

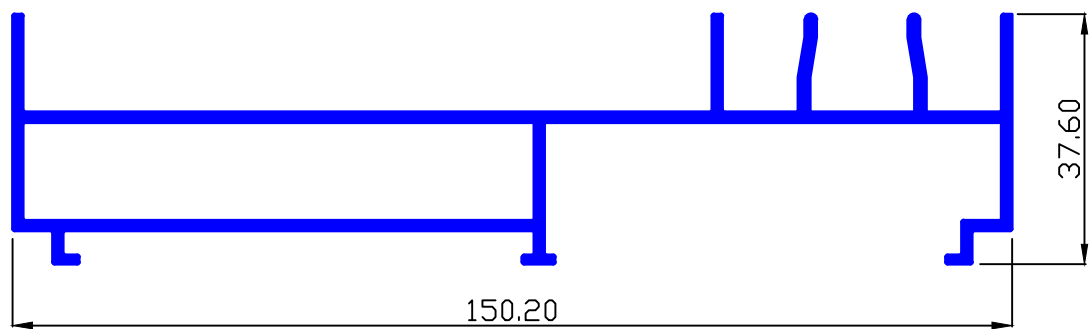

**MAAN SEC.-90069**

**1.514 Kg/Mtr.**

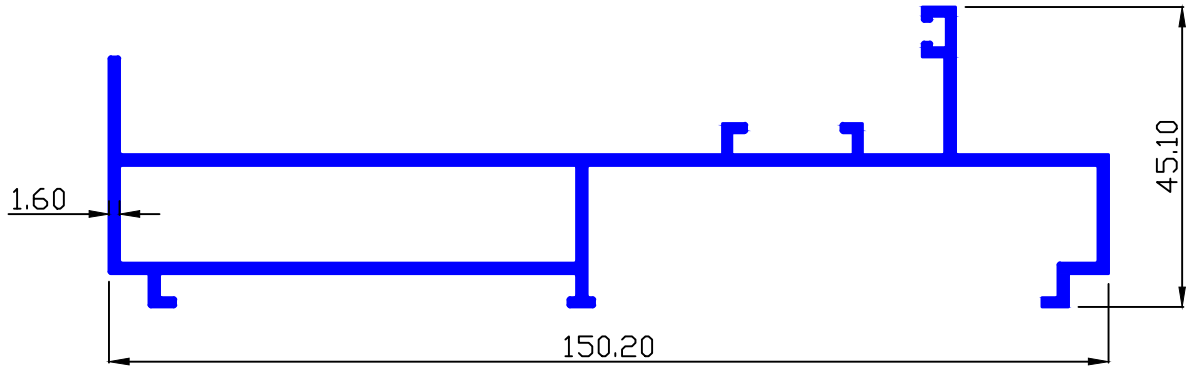

**MAAN SEC.-90068**

**1.864 Kg/Mtr.**

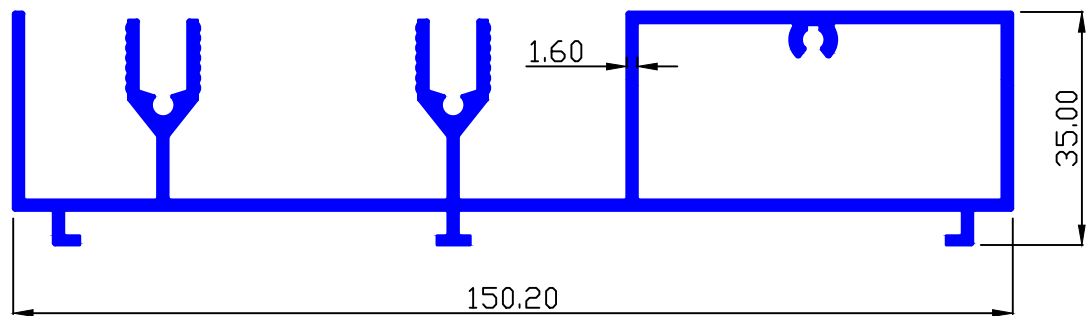



**MISCELLANEOUS  
ARCHITECTURAL**

**MAAN SEC.-90067**

**2.956 Kg/Mtr.**

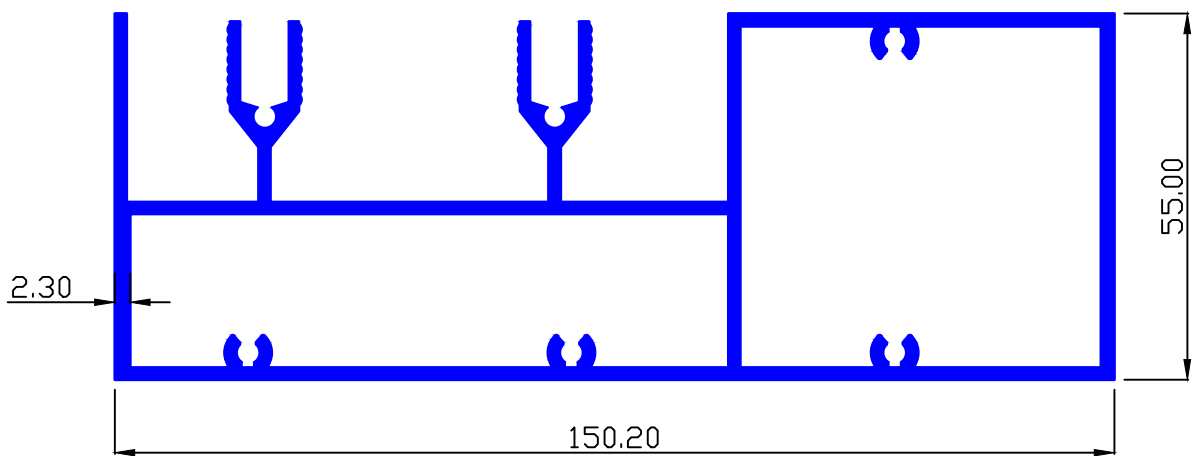

**MAAN SEC.-90066**

**1.642 Kg/Mtr.**

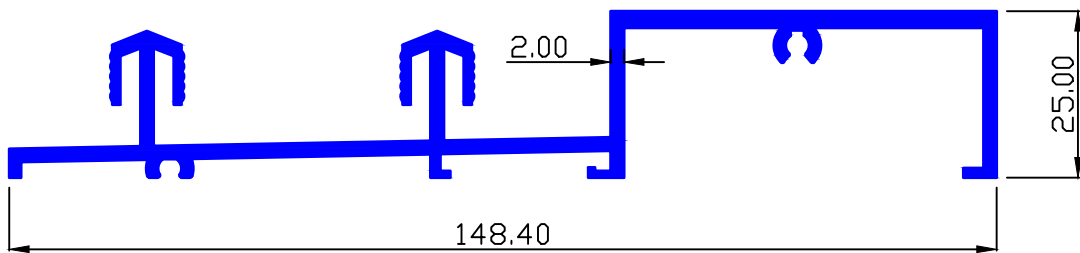

**MAAN SEC.-90433**

**0.642 Kg/Mtr.**

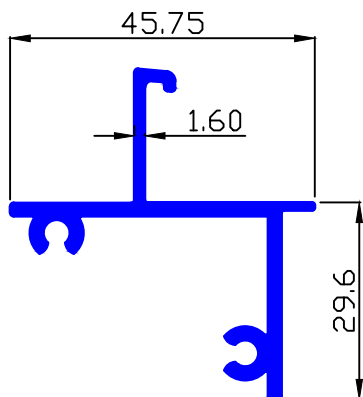

**MAAN SEC.-90434**

**0.495 Kg/Mtr.**

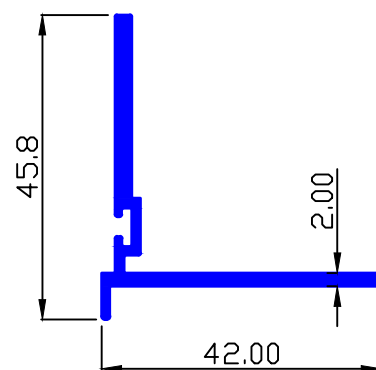



**MISCELLANEOUS  
ARCHITECTURAL**

**MAAN SEC.-90665**

**0.968 Kg/Mtr.**

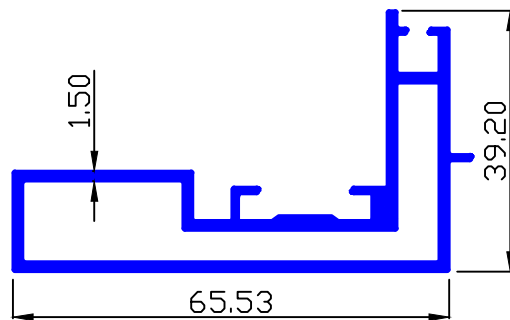

**MAAN SEC.-90430**

**1.797 Kg/Mtr.**

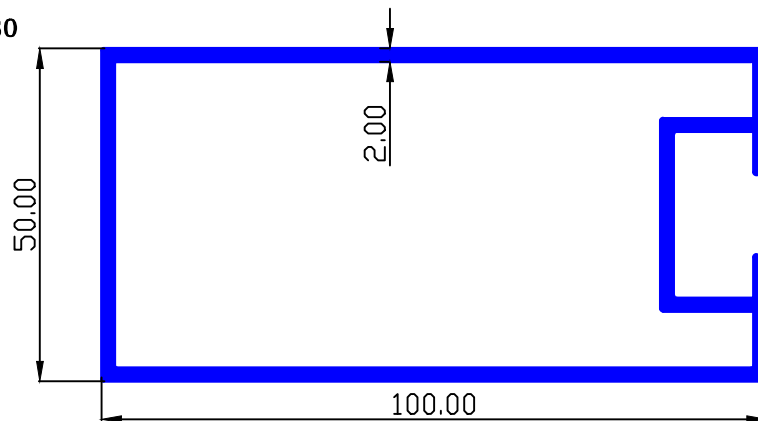

**MAAN SEC.-90427**

**0.879 Kg/Mtr.**

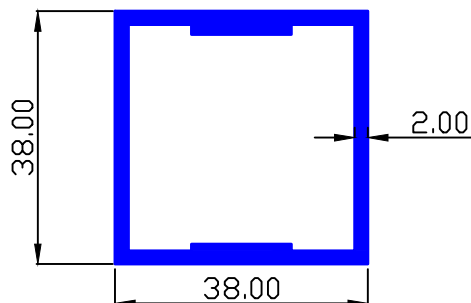

**MAAN SEC.-90432**

**0.218 Kg/Mtr.**

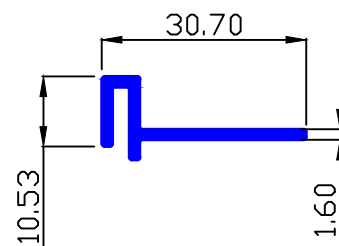



**MISCELLANEOUS  
ARCHITECTURAL**

**MAAN SEC.-90462**

**6.043 Kg/Mtr.**

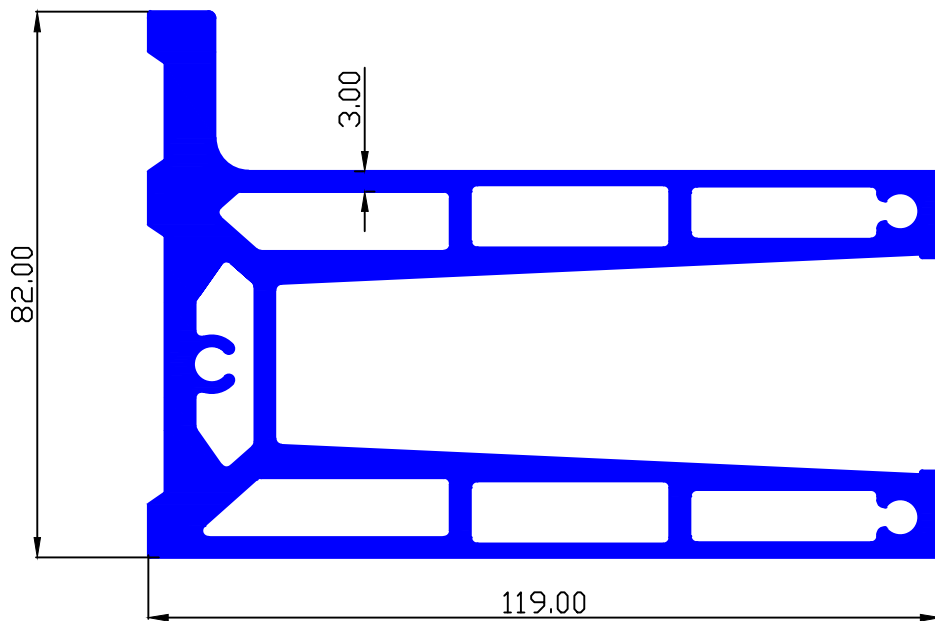

**MAAN SEC.-90476**

**0.336 Kg/Mtr.**

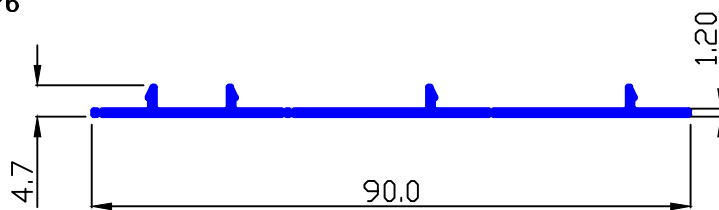

**MAAN SEC.-90475**

**0.210 Kg/Mtr.**

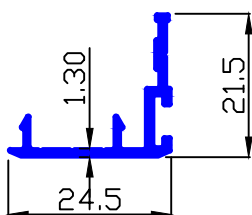

**MAAN SEC.-90482**

**0.327 Kg/Mtr.**

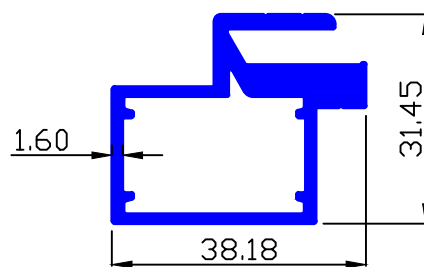



**MISCELLANEOUS  
ARCHITECTURAL**

**MAAN SEC.-90621**

**6.579 Kg/Mtr.**

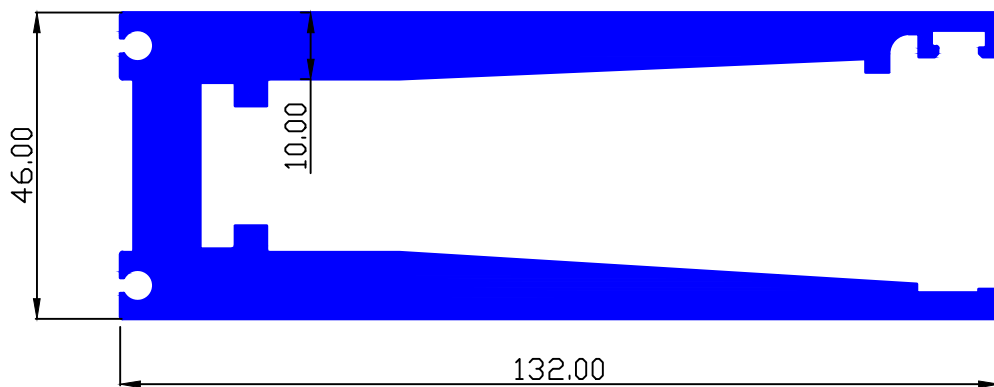

**MAAN SEC.-90483**

**1.228 Kg/Mtr.**

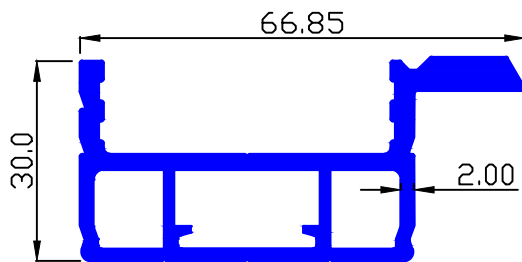

**MAAN SEC.-90498**

**0.255 Kg/Mtr.**

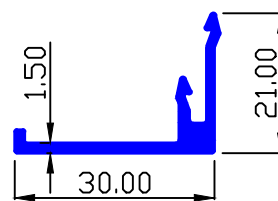

**MAAN SEC.-90582**

**2.614 Kg/Mtr.**

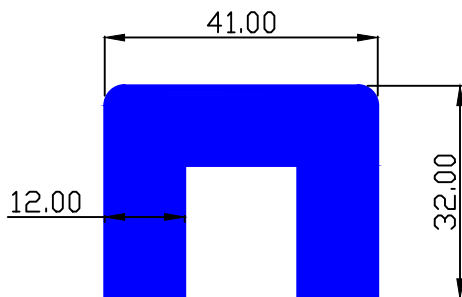

**MAAN SEC.-90664**

**0.456 Kg/Mtr.**

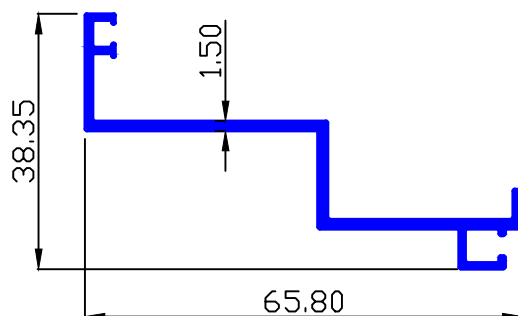



**MISCELLANEOUS  
ARCHITECTURAL**

**MAAN SEC.-90712**

**0.332 Kg/Mtr.**

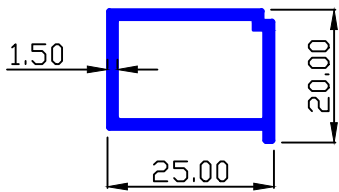

**MAAN SEC.-90715**

**0.392 Kg/Mtr.**

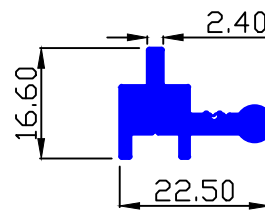

**MAAN SEC.-90714**

**1.363 Kg/Mtr.**

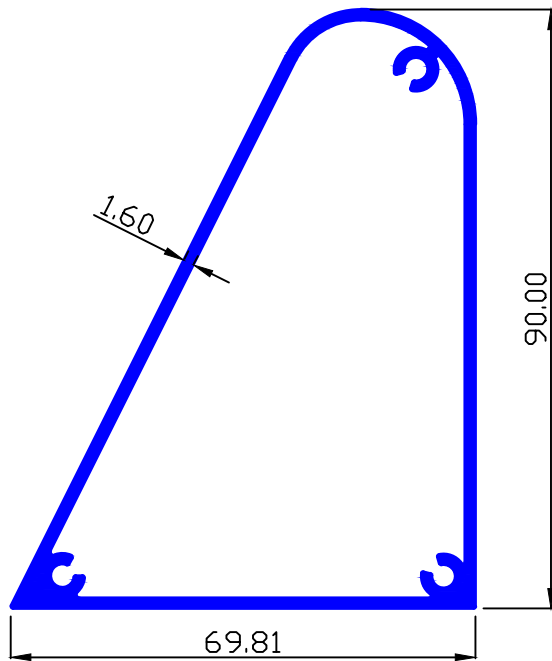

**MAAN SEC.-90713**

**1.151 Kg/Mtr.**

