

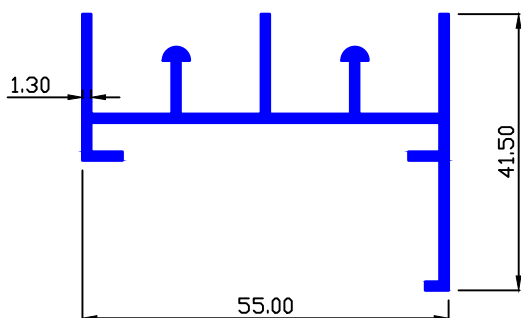

SLIDING WINDOW

MAAN SEC.-8530

0.591 Kg/Mtr.



MAAN SEC.-7807

0.499 Kg/Mtr.

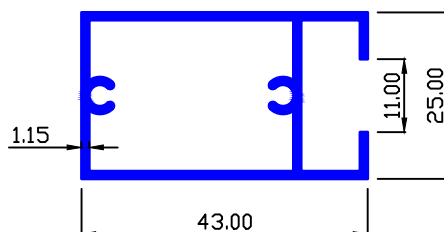

MAAN SEC.-6705

0.460 Kg/Mtr.

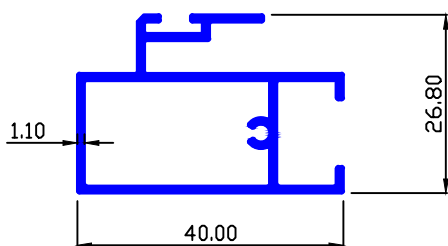

MAAN SEC.-7823

0.414 Kg/Mtr.

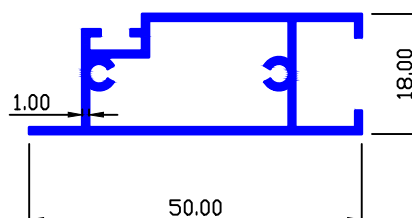

MAAN SEC.-6706

0.462 Kg/Mtr.

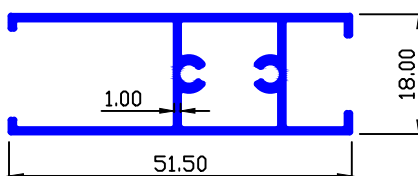

MAAN SEC.-7969

0.608 Kg/Mtr.

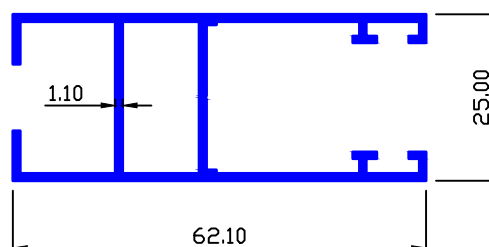

MAAN SEC.-6707

0.465 Kg/Mtr.

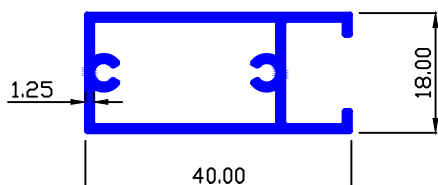

MAAN SEC.-7972

0.663 Kg/Mtr.

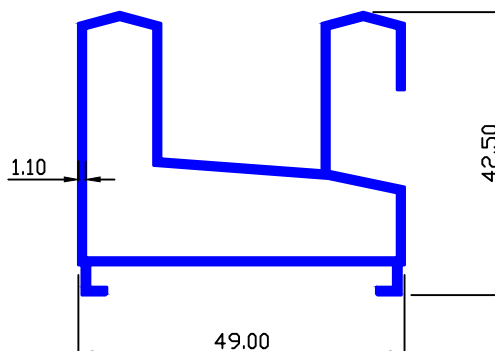

MAAN SEC.-6709

0.465 Kg/Mtr.

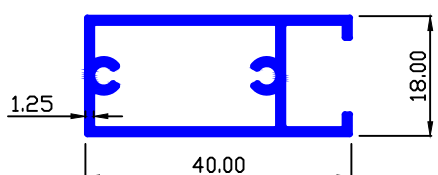



SLIDING WINDOW

MAAN SEC.-6710

1.390 Kg/Mtr.

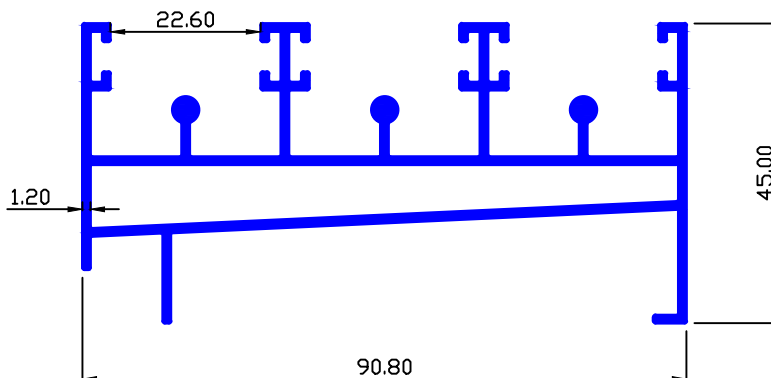

MAAN SEC.-6712/EH

1.106 Kg/Mtr.

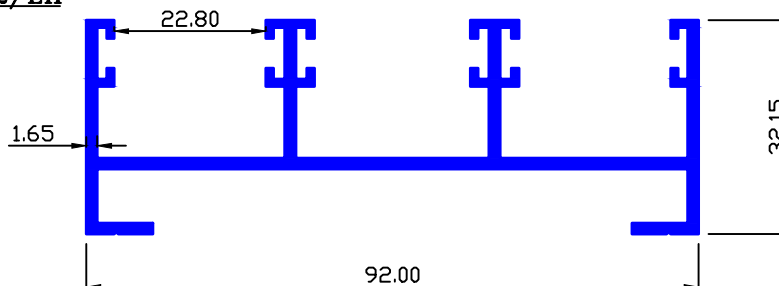

MAAN SEC.-6712/EHH

1.391 Kg/Mtr.

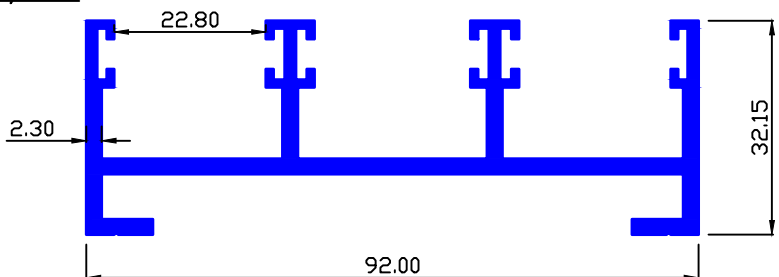

MAAN SEC.-6714/EH

1.253 Kg/Mtr.

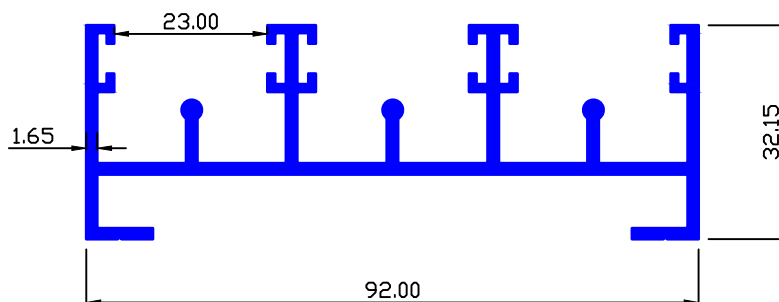



SLIDING WINDOW

MAAN SEC.-6714/EHH

1.577 Kg/Mtr.

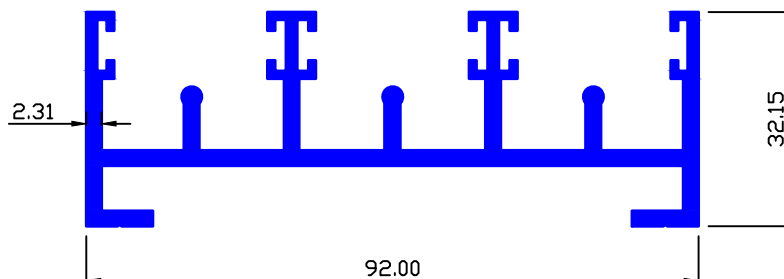

MAAN SEC.-6715

0.613 Kg/Mtr.

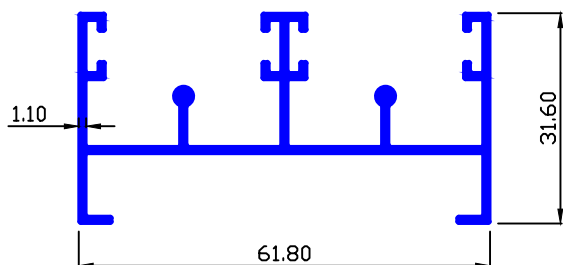

MAAN SEC.-7808

0.348 Kg/Mtr.

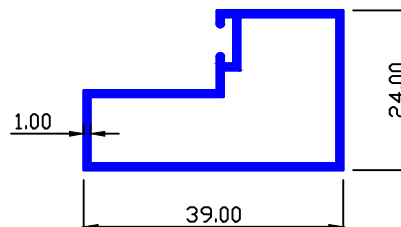

MAAN SEC.-6718

0.616 Kg/Mtr.

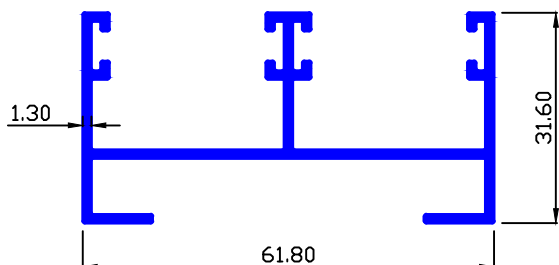

MAAN SEC.-7827

0.870 Kg/Mtr.

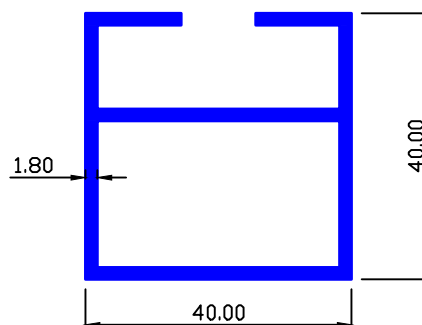

MAAN SEC.-6723

0.218 Kg/Mtr.

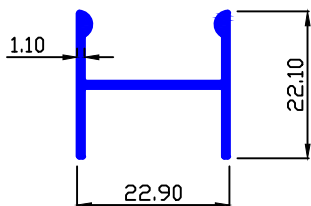

MAAN SEC.-7678

0.443 Kg/Mtr.

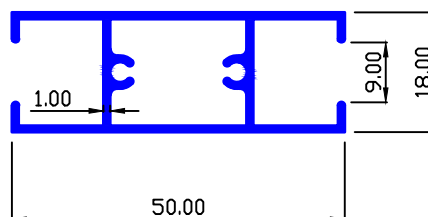



SLIDING WINDOW

MAAN SEC.-6720

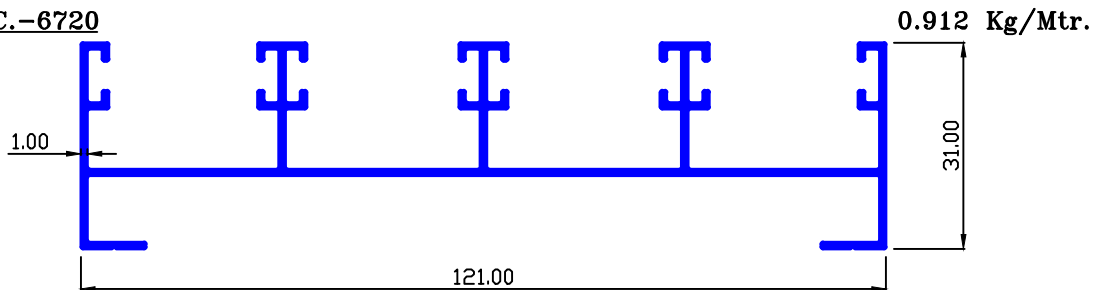

MAAN SEC.-6721/H

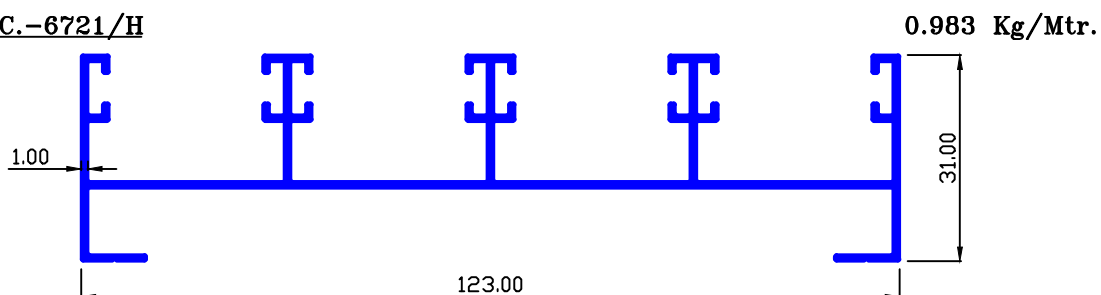

MAAN SEC.-6722/H

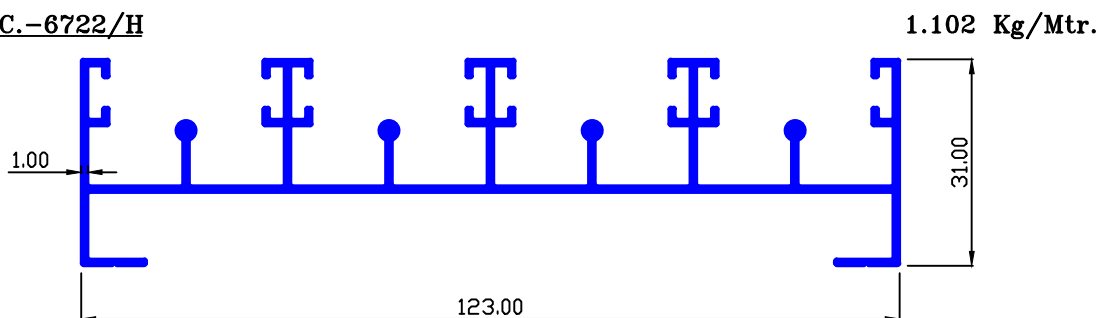

MAAN SEC.-6724

0.224 Kg/Mtr.

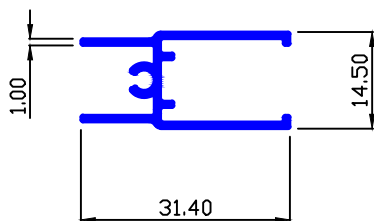

MAAN SEC.-6725

1.220 Kg/Mtr.

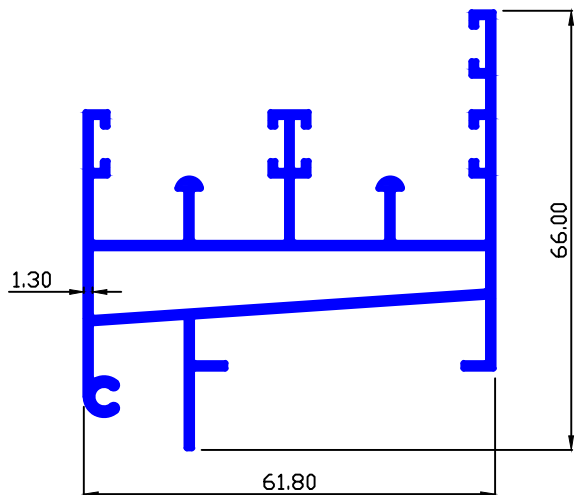



SLIDING WINDOW

MAAN SEC.-7677

0.620 Kg/Mtr.

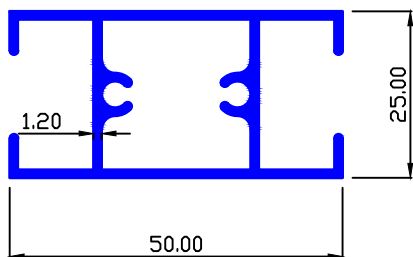

MAAN SEC.-7669

0.524 Kg/Mtr.

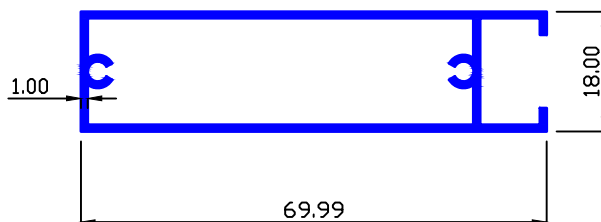

MAAN SEC.-6752

2.180 Kg/Mtr.

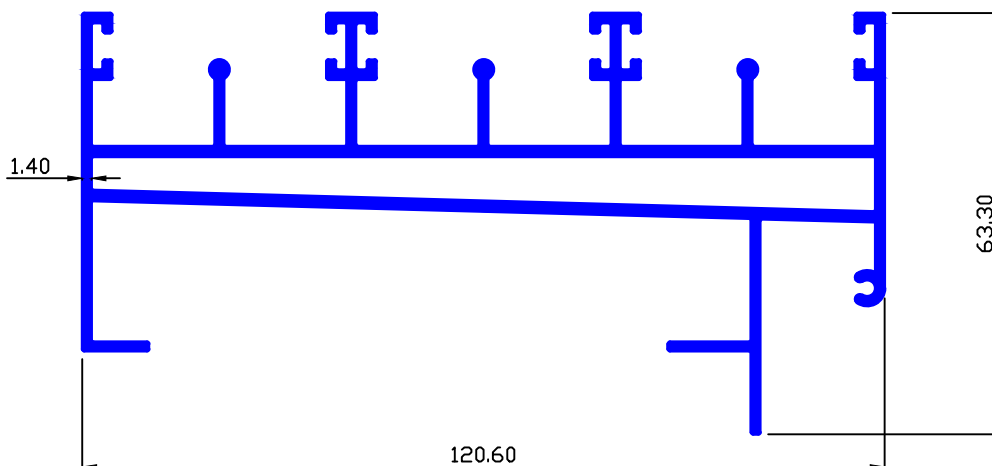

MAAN SEC.-6758

0.765 Kg/Mtr.

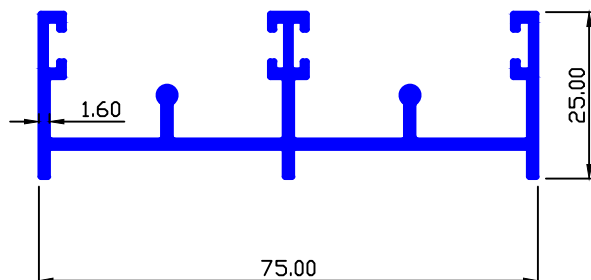

MAAN SEC.-6759

0.628 Kg/Mtr.

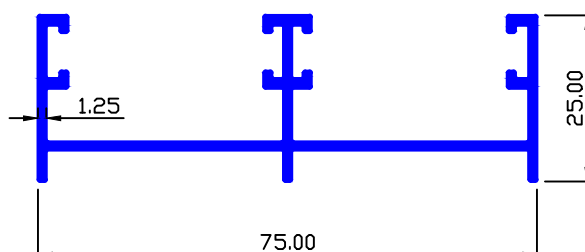



SLIDING WINDOW

MAAN SEC.-6760

0.655 Kg/Mtr.

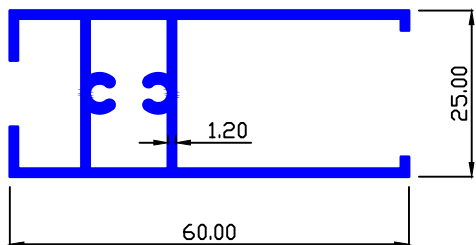

MAAN SEC.-6761

0.661 Kg/Mtr.

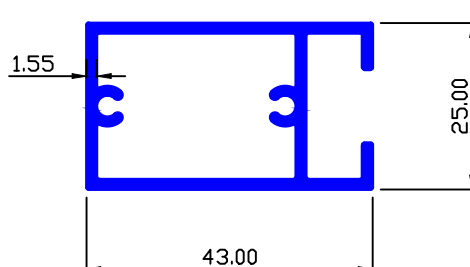

MAAN SEC.-6762

1.366 Kg/Mtr.

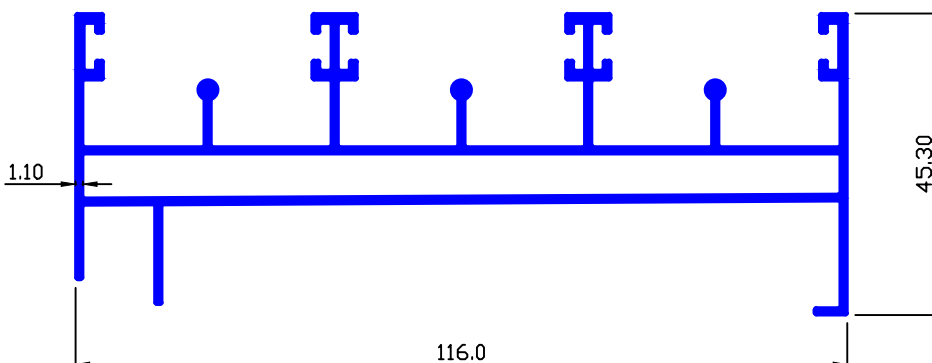

MAAN SEC.-7670

0.502 Kg/Mtr.

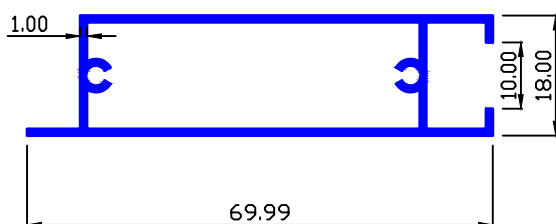

MAAN SEC.-6799

0.873 Kg/Mtr.

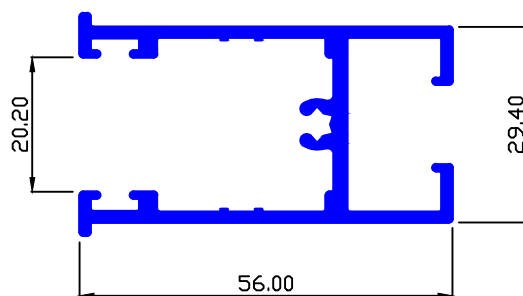

MAAN SEC.-6764

0.642 Kg/Mtr.

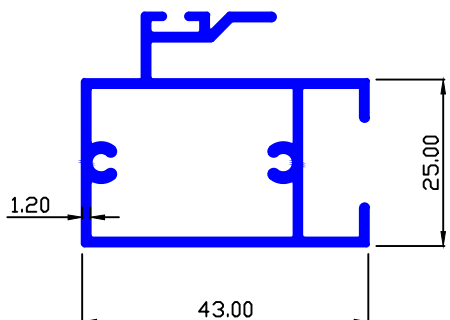

MAAN SEC.-6765

0.670 Kg/Mtr.

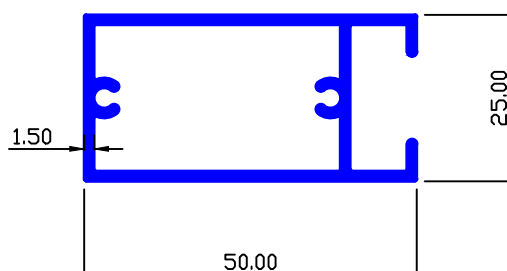



SLIDING WINDOW

MAAN SEC.-7659

0.374 Kg/Mtr.

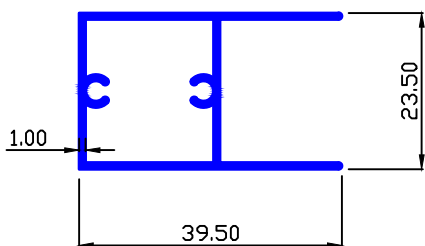

MAAN SEC.-6775

1.060 Kg/Mtr.

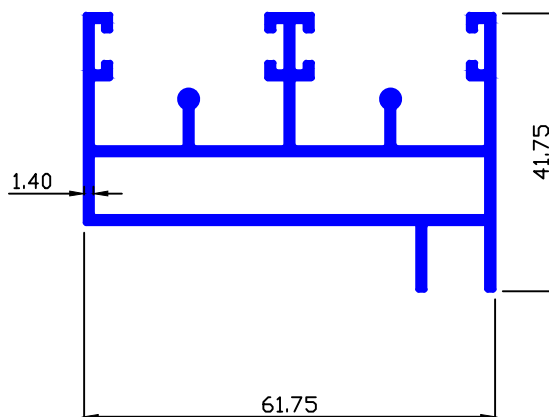

MAAN SEC.-6773

1.476 Kg/Mtr.

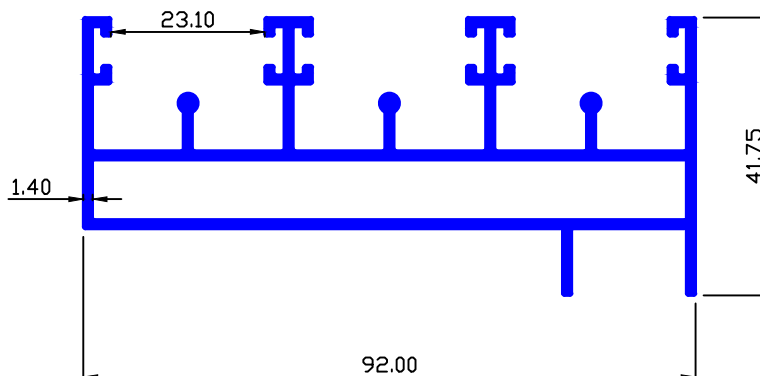

MAAN SEC.-6790

0.312 Kg/Mtr.

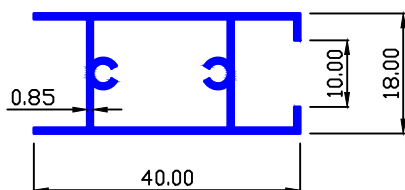

MAAN SEC.-6795

0.866 Kg/Mtr.

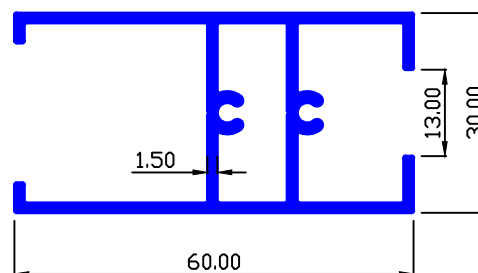



SLIDING WINDOW

MAAN SEC.-6776

0.780 Kg/Mtr.

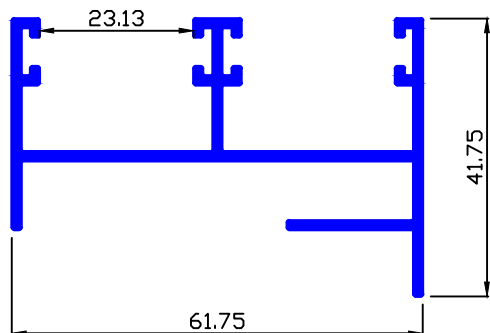

MAAN SEC.-6787

0.373 Kg/Mtr.

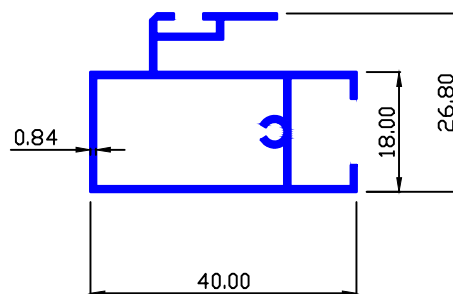

MAAN SEC.-6777

1.783 Kg/Mtr.

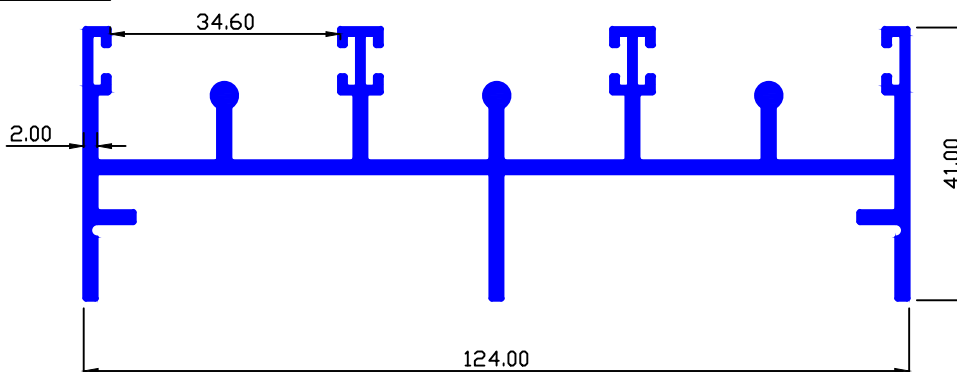

MAAN SEC.-8545

0.169 Kg/Mtr.

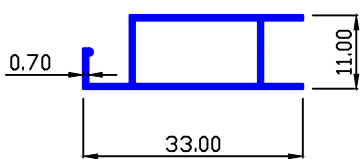

MAAN SEC.-8542

0.270 Kg/Mtr.

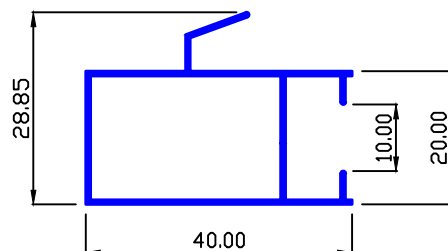

MAAN SEC.-6788

0.370 Kg/Mtr.

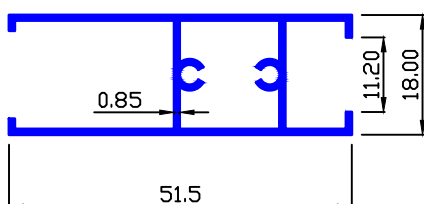

MAAN SEC.-6789

0.311 Kg/Mtr.

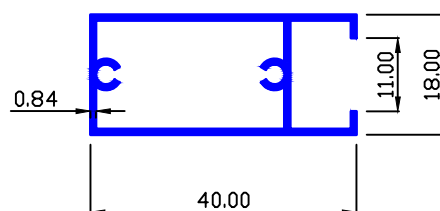



SLIDING WINDOW

MAAN SEC.-89052

1.343 Kg/Mtr.

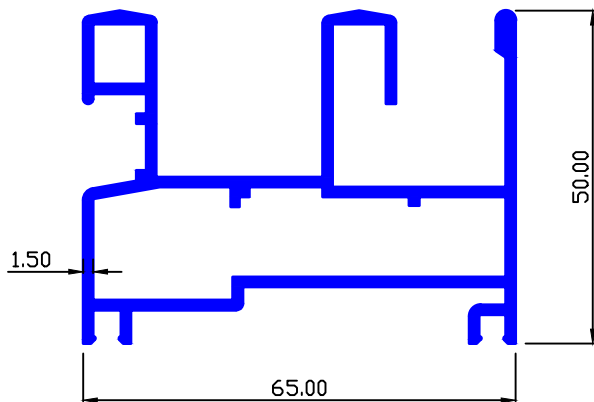

MAAN SEC.-89054

0.916 Kg/Mtr.

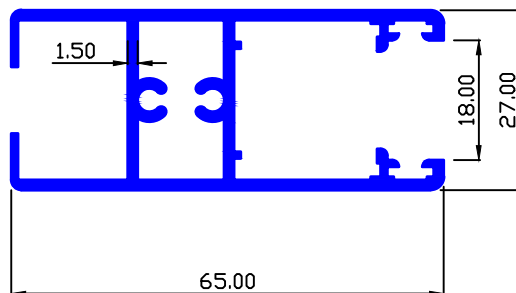

MAAN SEC.-89053

1.893 Kg/Mtr.

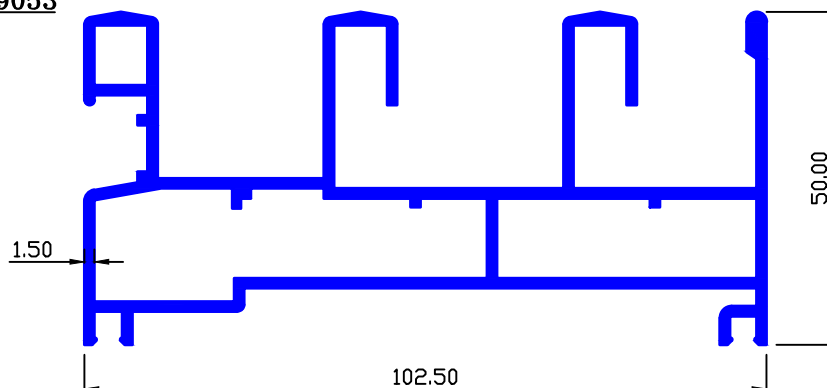

MAAN SEC.-89060

0.211 Kg/Mtr.

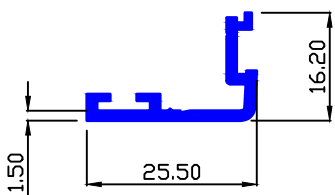

MAAN SEC.-89173

0.269 Kg/Mtr.

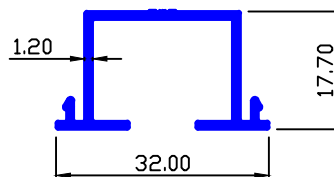

MAAN SEC.-89098

1.431 Kg/Mtr.

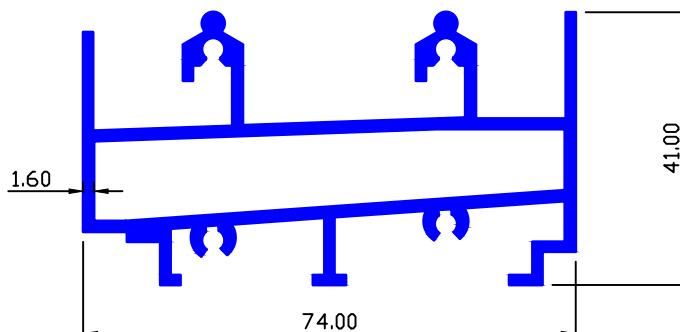



SLIDING WINDOW

MAAN SEC.-9297

0.948 Kg/Mtr.

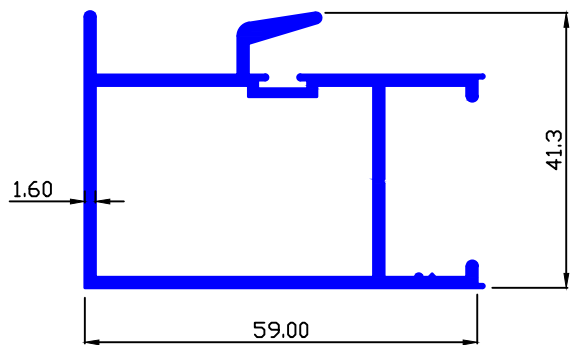

MAAN SEC.-9379

0.512 Kg/Mtr.

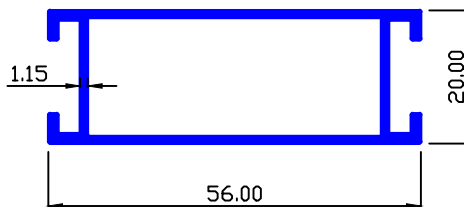

MAAN SEC.-89026

0.312 Kg/Mtr.

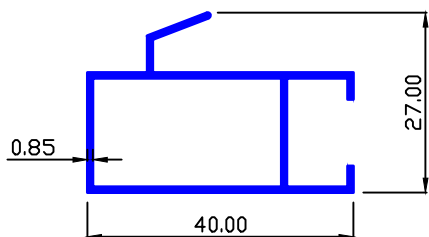

MAAN SEC.-89027

0.275 Kg/Mtr.

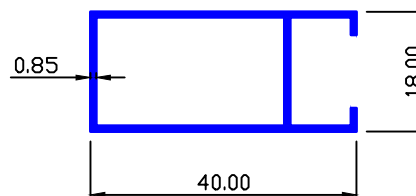

MAAN SEC.-89028

0.295 Kg/Mtr.

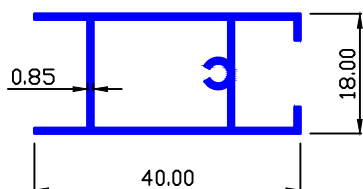

MAAN SEC.-89037

0.856 Kg/Mtr.

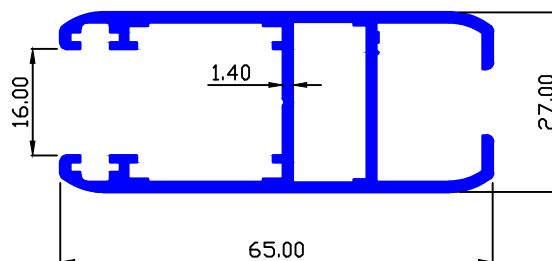

MAAN SEC.-89036

0.913 Kg/Mtr.

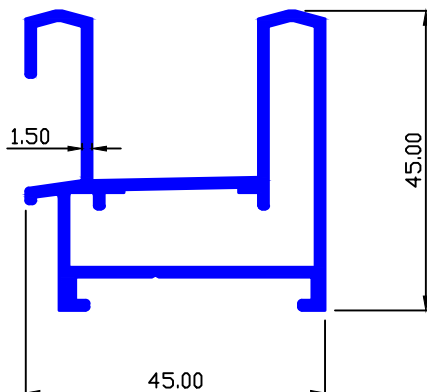

MAAN SEC.-89051

0.352 Kg/Mtr.

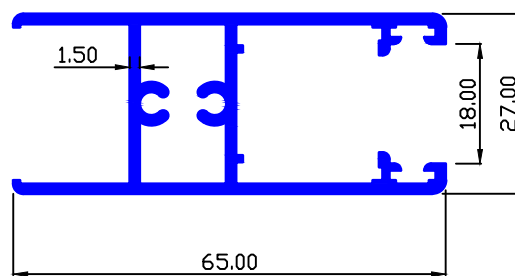



SLIDING WINDOW

MAAN SEC.-8531

0.432 Kg/Mtr.

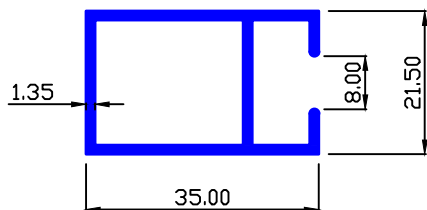

MAAN SEC.-8532

0.463 Kg/Mtr.

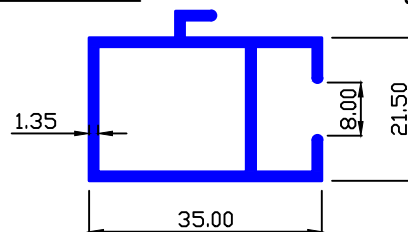

MAAN SEC.-8533

0.502 Kg/Mtr.

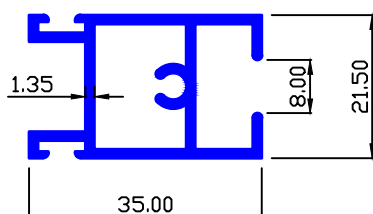

MAAN SEC.-8541

0.290 Kg/Mtr.

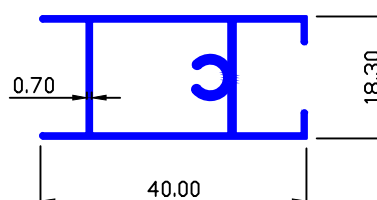

MAAN SEC.-8542

0.270 Kg/Mtr.

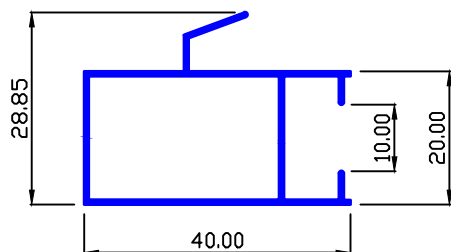

MAAN SEC.-8964

0.163 Kg/Mtr.

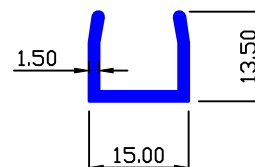

MAAN SEC.-9296

0.798 Kg/Mtr.

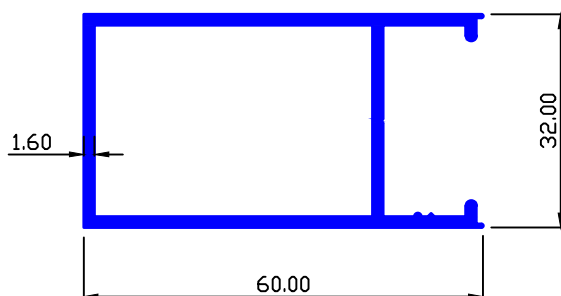

MAAN SEC.-8992

1.516 Kg/Mtr.

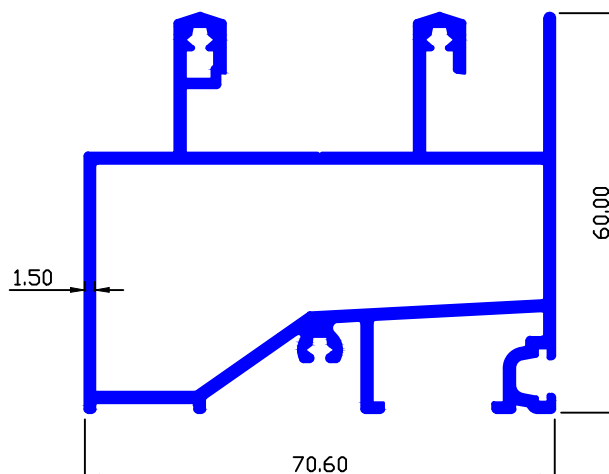



SLIDING WINDOW

MAAN SEC.-8546

0.239 Kg/Mtr.

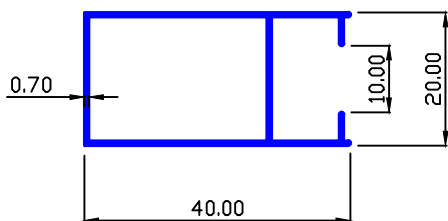

MAAN SEC.-8699

0.880 Kg/Mtr.

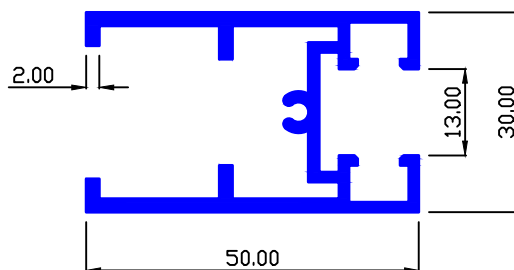

MAAN SEC.-8697

1.159 Kg/Mtr.

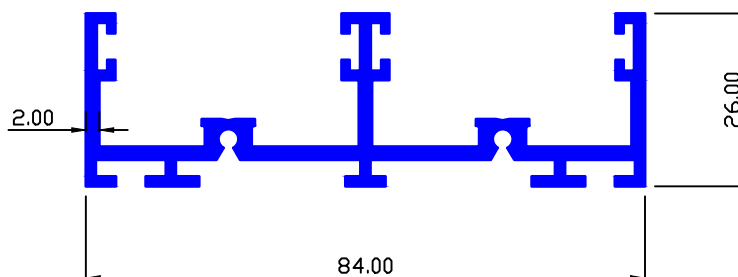

MAAN SEC.-8702

1.822 Kg/Mtr.

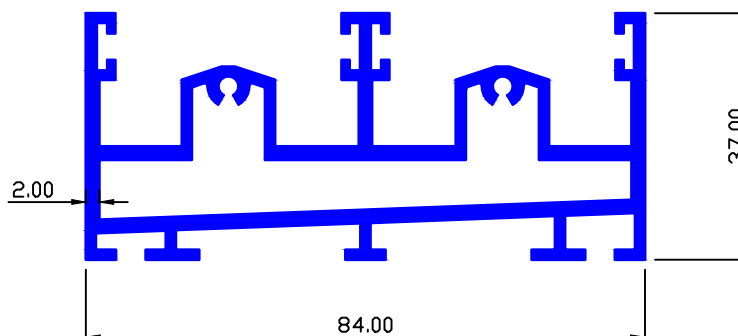

MAAN SEC.-8703

0.935 Kg/Mtr.

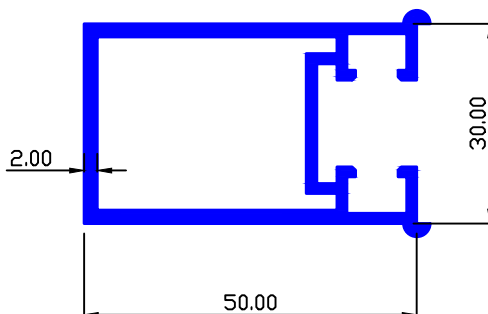

MAAN SEC.-8750

0.841 Kg/Mtr.

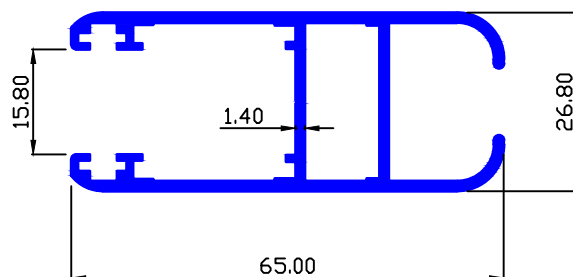



SLIDING WINDOW

MAAN SEC.-8704

1.672 Kg/Mtr.

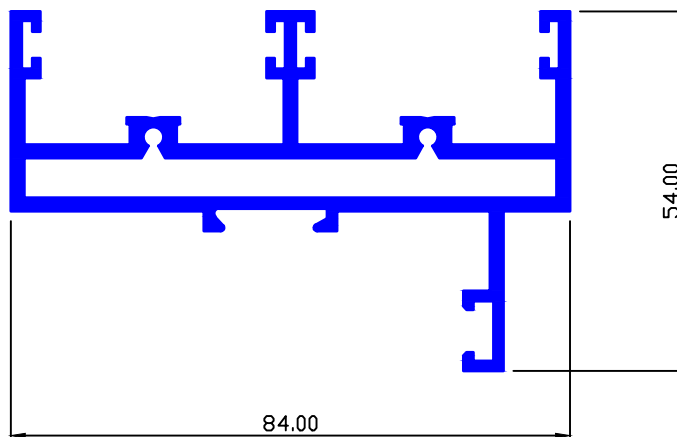

MAAN SEC.-8749

1.532 Kg/Mtr.

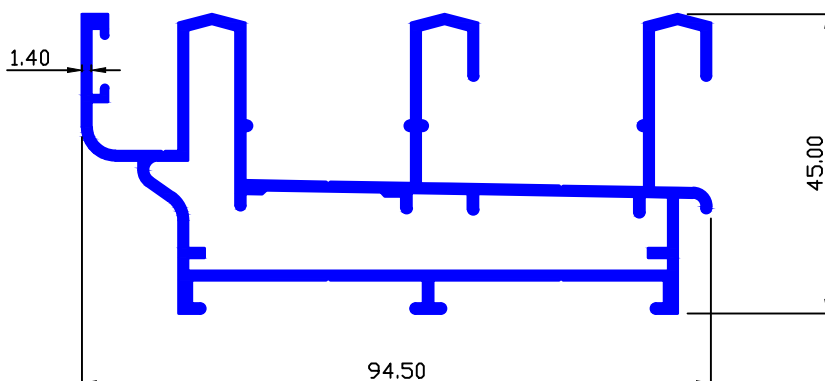

MAAN SEC.-8752

1.073 Kg/Mtr.

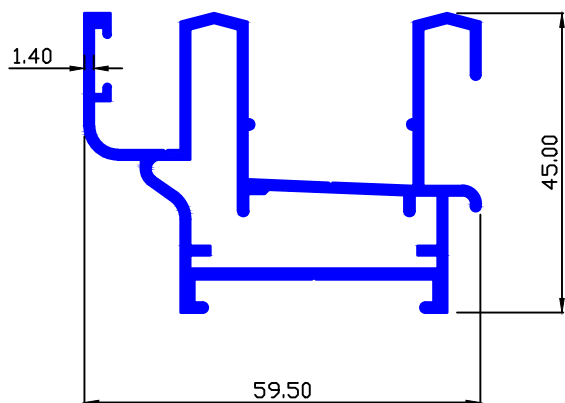

MAAN SEC.-8807

0.921 Kg/Mtr.

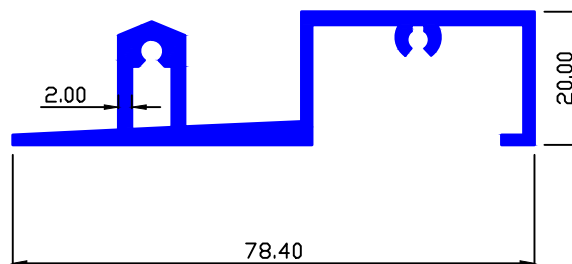



SLIDING WINDOW

MAAN SEC.-8811

1.395 Kg/Mtr.

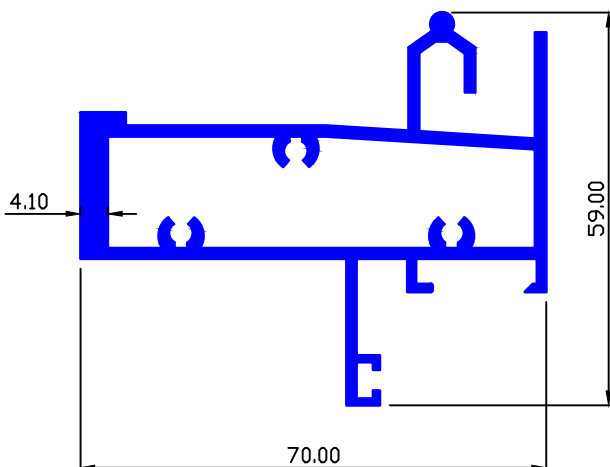

MAAN SEC.-8938

0.825 Kg/Mtr.

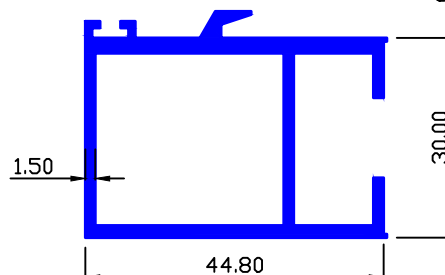

MAAN SEC.-8838

0.804 Kg/Mtr.

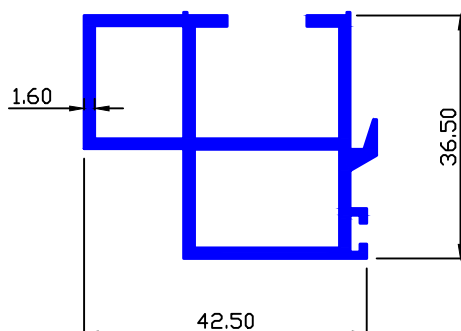

MAAN SEC.-8839

0.799 Kg/Mtr.

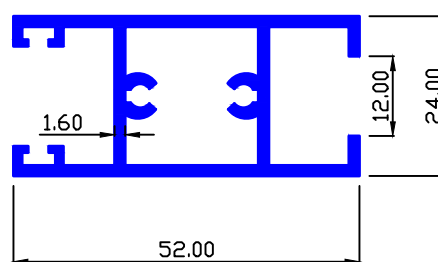

MAAN SEC.-8848

0.707 Kg/Mtr.

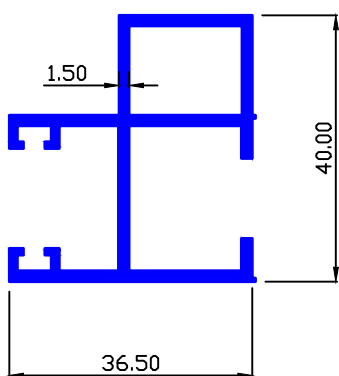

MAAN SEC.-8865

0.303 Kg/Mtr.

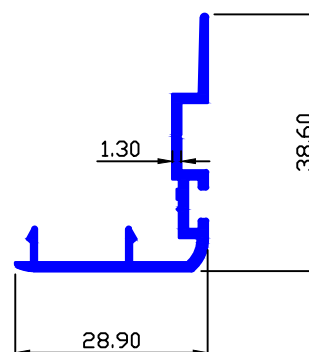



SLIDING WINDOW

MAAN SEC.-8907

0.994 Kg/Mtr.

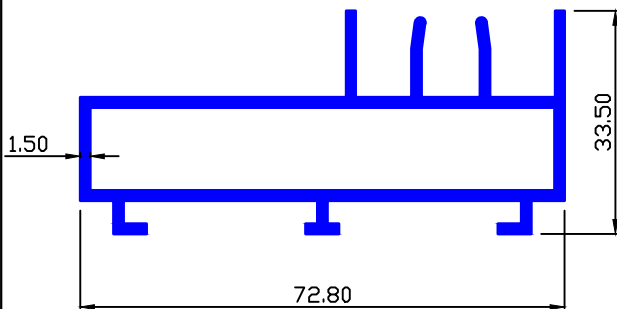

MAAN SEC.-8912

1.299 Kg/Mtr.

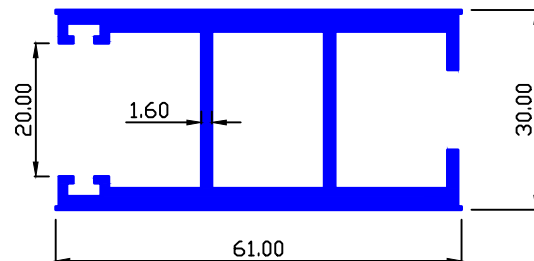

MAAN SEC.-8913

1.264 Kg/Mtr.

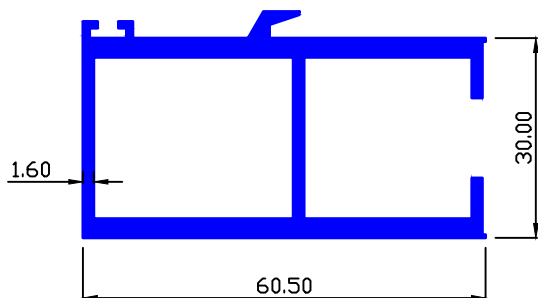

MAAN SEC.-8914

1.223 Kg/Mtr.

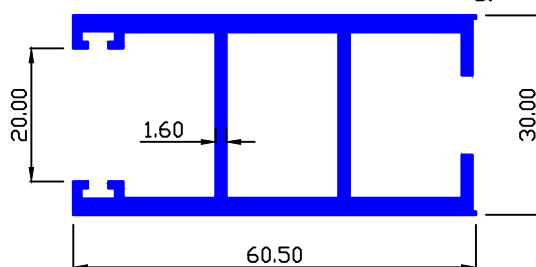

MAAN SEC.-8915

1.086 Kg/Mtr.

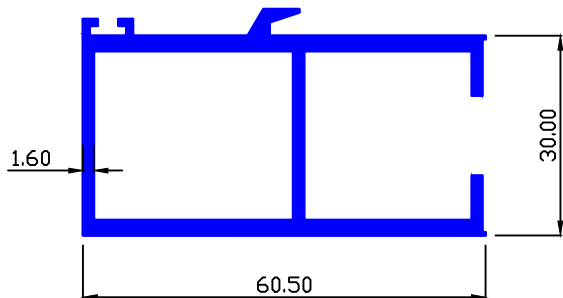

MAAN SEC.-8917

1.208 Kg/Mtr.

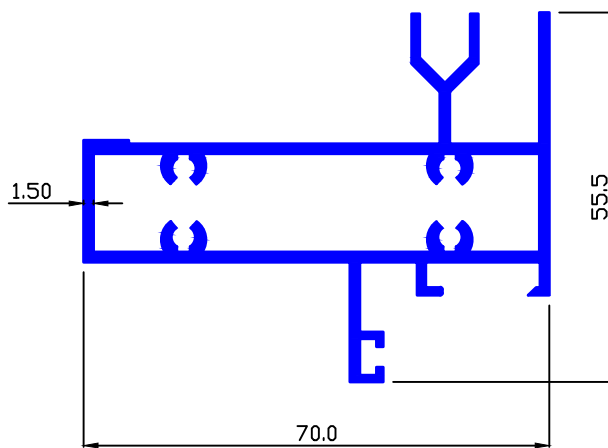

MAAN SEC.-8916

1.406 Kg/Mtr.

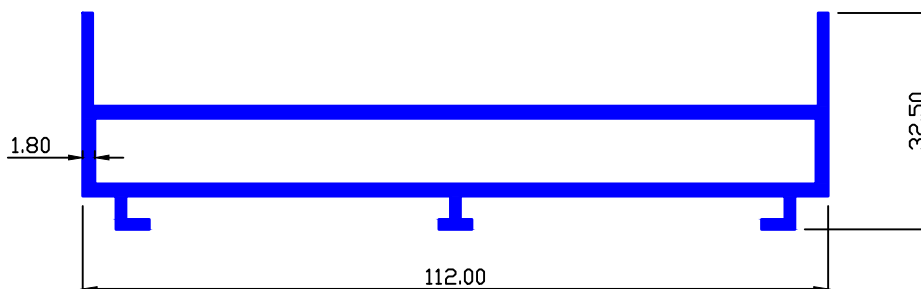



SLIDING WINDOW

MAAN SEC.-8918

2.036 Kg/Mtr.

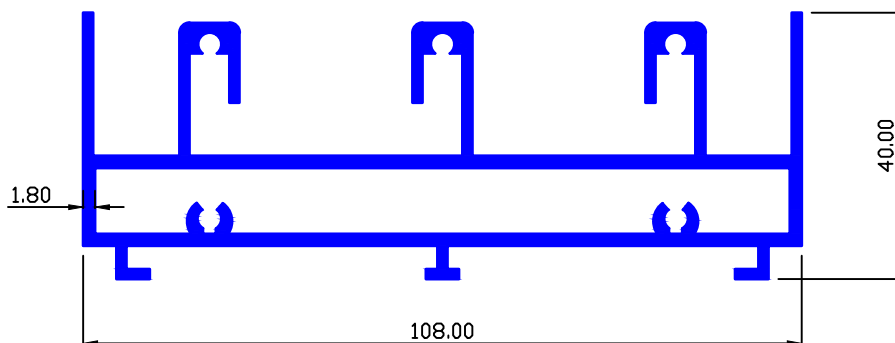

MAAN SEC.-8921

1.155 Kg/Mtr.

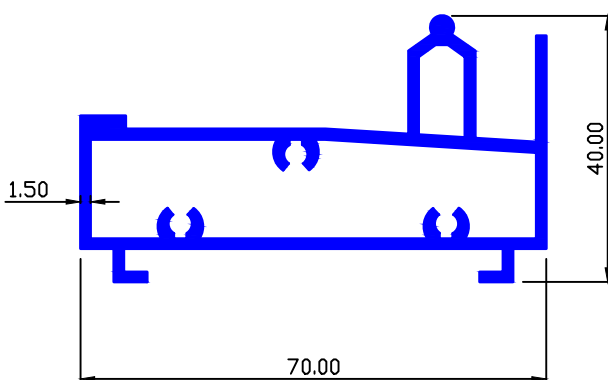

MAAN SEC.-8926

1.181 Kg/Mtr.

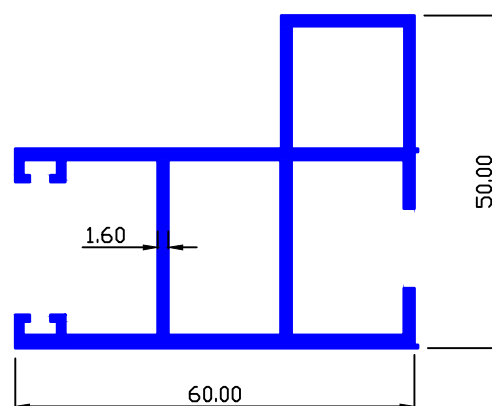

MAAN SEC.-8925

2.099 Kg/Mtr.

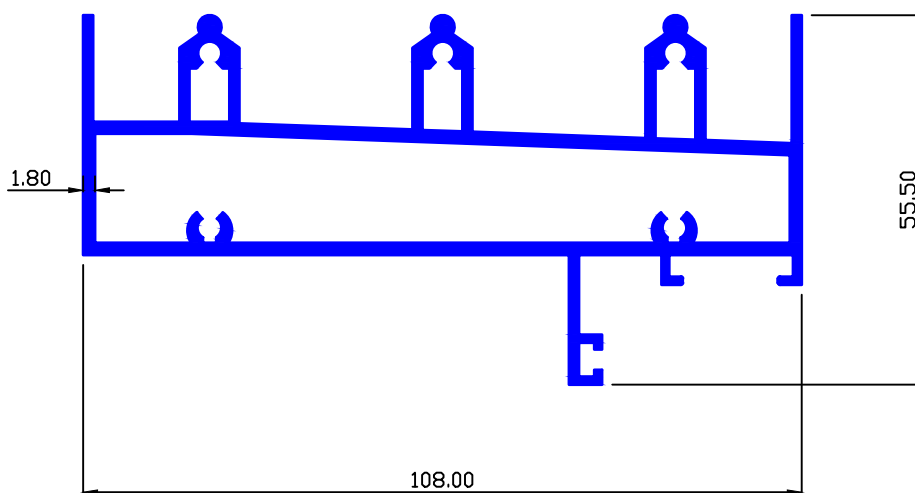



SLIDING WINDOW

MAAN SEC.-8927

1.172 Kg/Mtr.

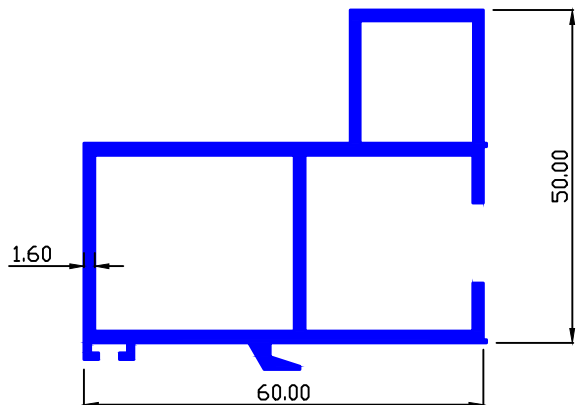

MAAN SEC.-8936

0.750 Kg/Mtr.

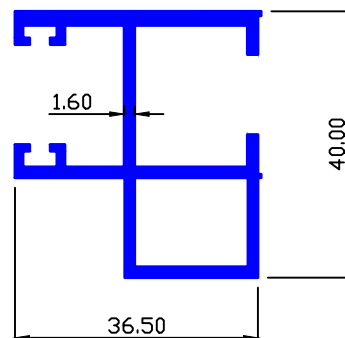

MAAN SEC.-8933

1.476 Kg/Mtr.

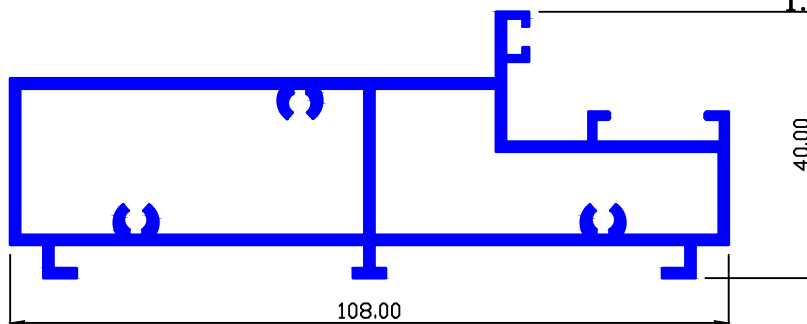

MAAN SEC.-89197

0.994 Kg/Mtr.

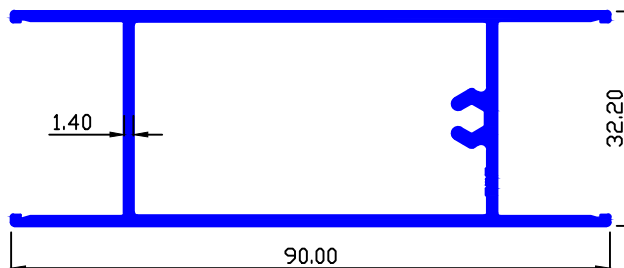

MAAN SEC.-8939

1.731 Kg/Mtr.

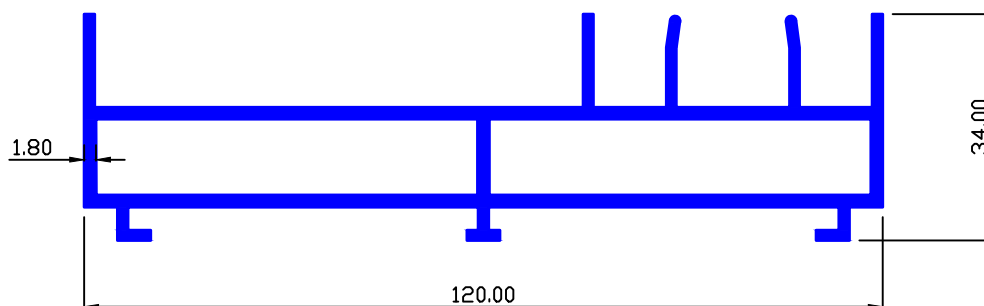



SLIDING WINDOW

MAAN SEC.-89258

0.180 Kg/Mtr.

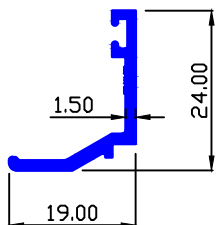

MAAN SEC.-89303

0.231 Kg/Mtr.

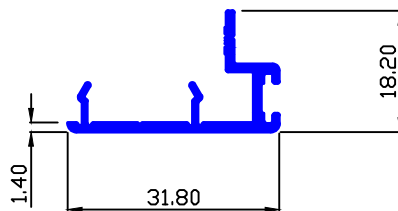

MAAN SEC.-89259

0.760 Kg/Mtr.

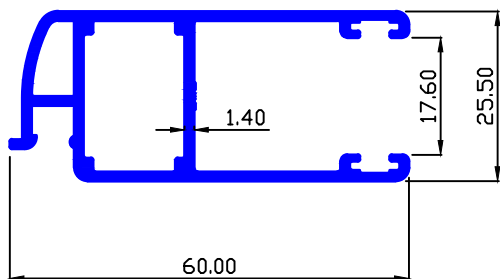

MAAN SEC.-89348

0.853 Kg/Mtr.

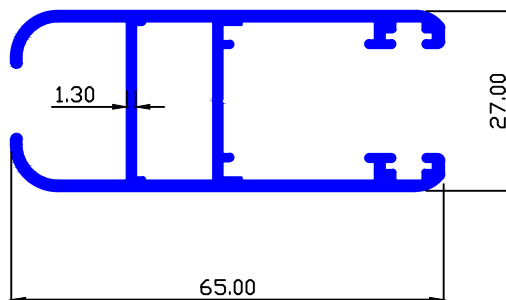

MAAN SEC.-8993

2.011 Kg/Mtr.

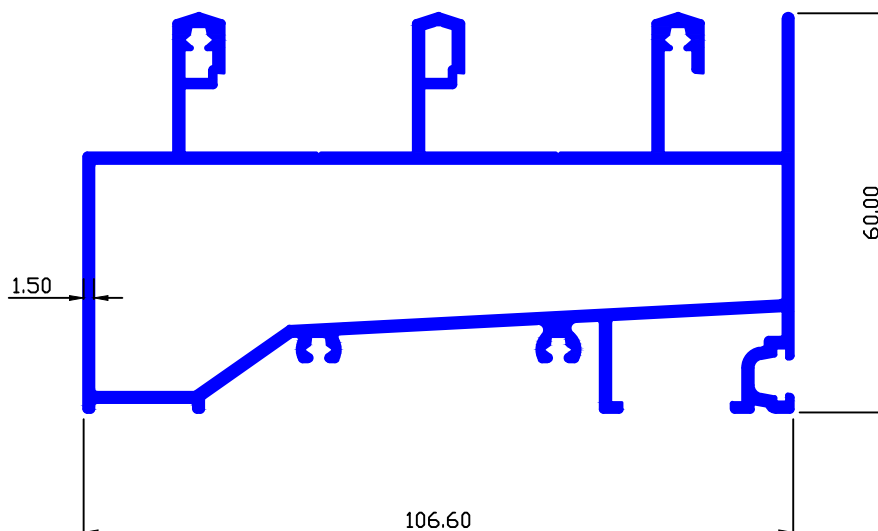



SLIDING WINDOW

MAAN SEC.-89164

0.752 Kg/Mtr.

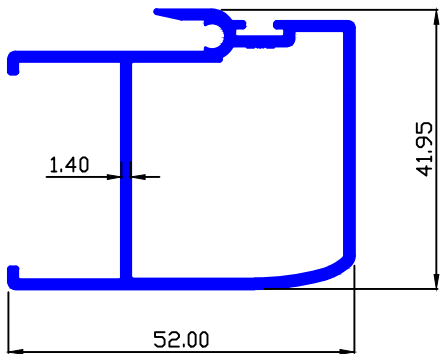

MAAN SEC.-89165

0.674 Kg/Mtr.

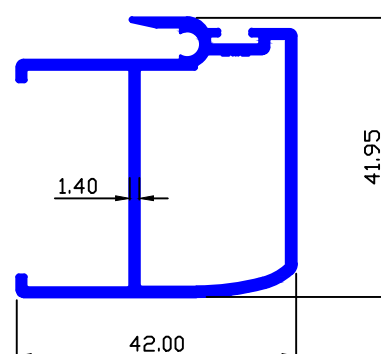

MAAN SEC.-89166

0.805 Kg/Mtr.

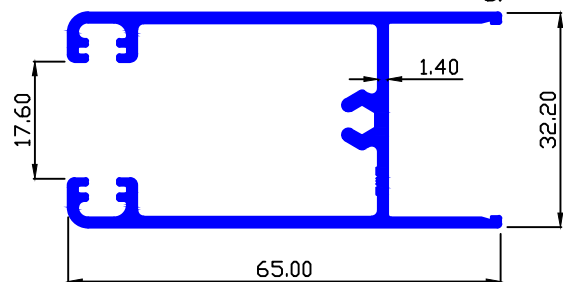

MAAN SEC.-89167

1.183 Kg/Mtr.

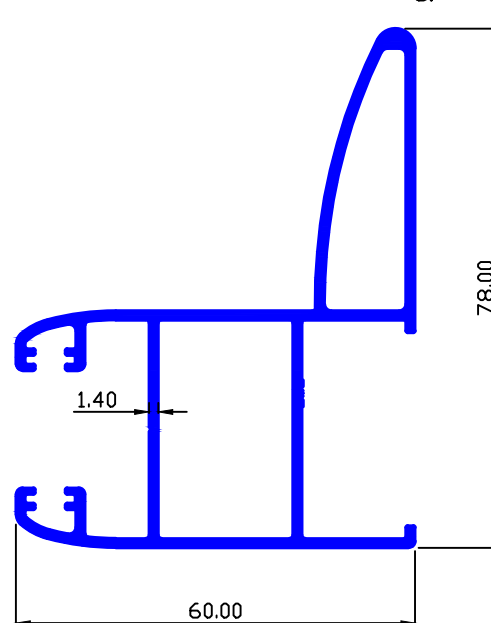

MAAN SEC.-89174

0.137 Kg/Mtr.

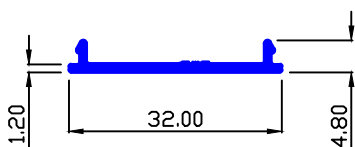

MAAN SEC.-89175

0.137 Kg/Mtr.

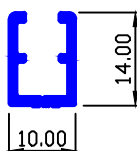

MAAN SEC.-89190

0.451 Kg/Mtr.

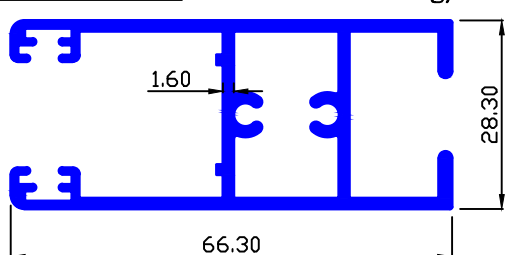

MAAN SEC.-89176

0.839 Kg/Mtr.

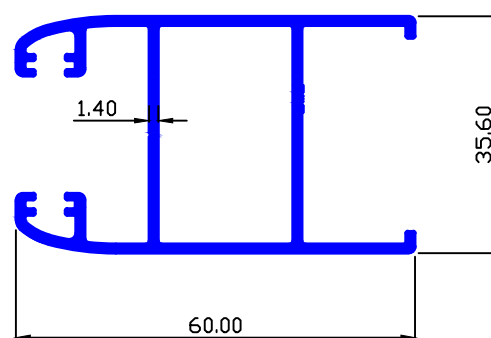



SLIDING WINDOW

MAAN SEC.-89349

0.337 Kg/Mtr.

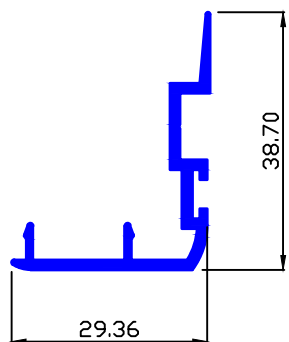

MAAN SEC.-89358

0.687 Kg/Mtr.

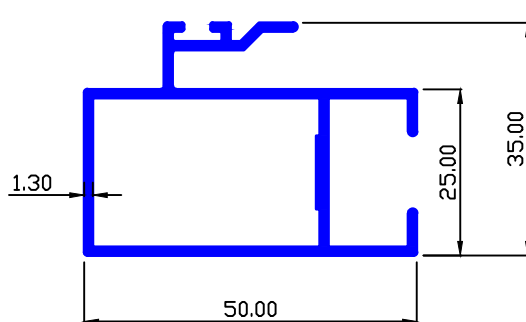

MAAN SEC.-89353

1.667 Kg/Mtr.

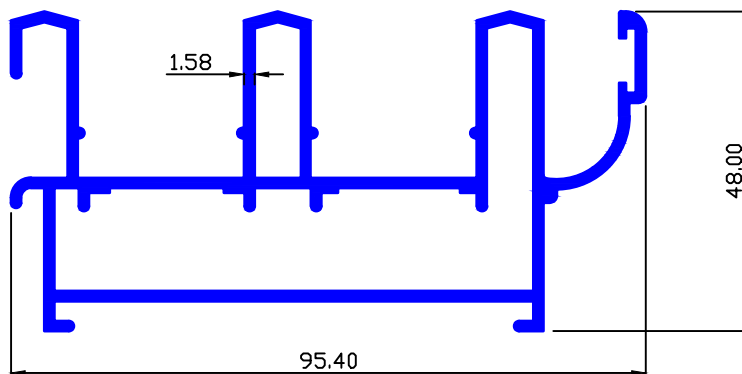

MAAN SEC.-89359

1.160 Kg/Mtr.

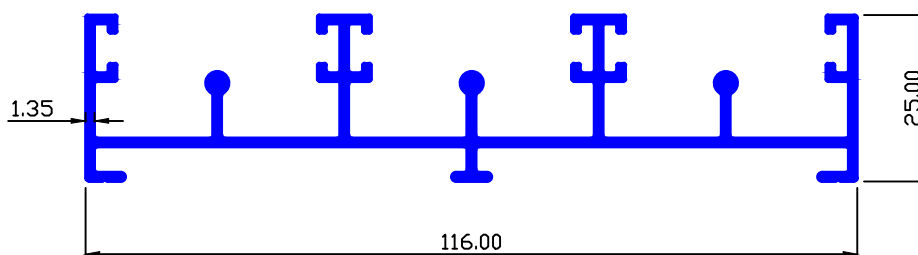

MAAN SEC.-89360

1.005 Kg/Mtr.

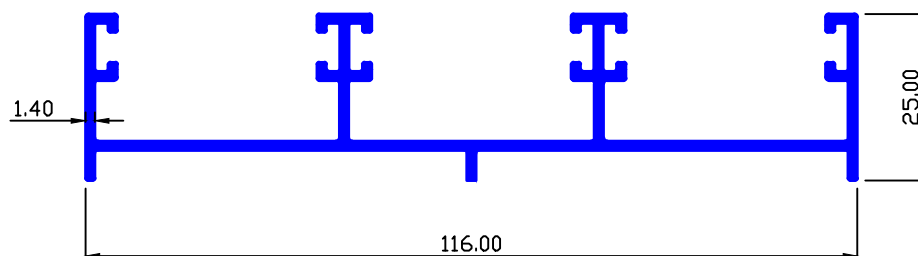



SLIDING WINDOW

MAAN SEC.-89386 0.593 Kg/Mtr.

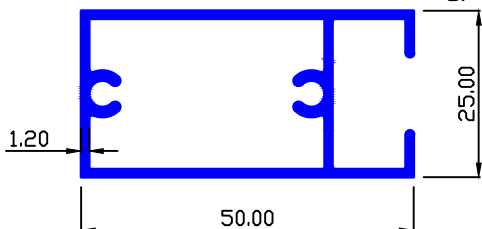

MAAN SEC.-89387 0.784 Kg/Mtr.

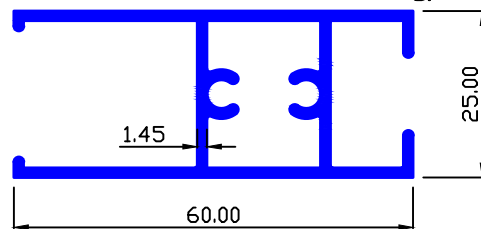

MAAN SEC.-89391 0.568 Kg/Mtr.

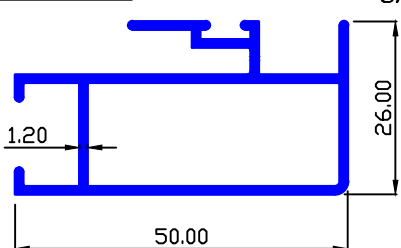

MAAN SEC.-89392 0.463 Kg/Mtr.

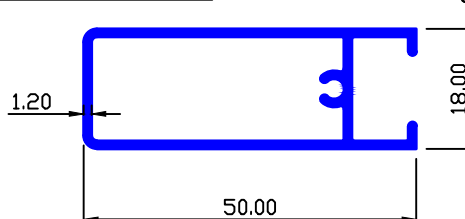

MAAN SEC.-89397 0.663 Kg/Mtr.

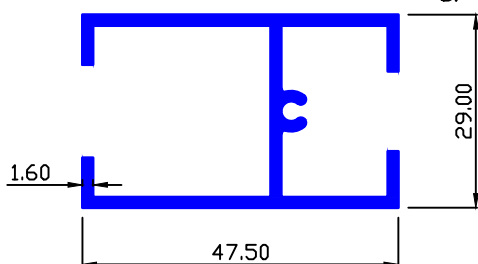

MAAN SEC.-89400 0.767 Kg/Mtr.

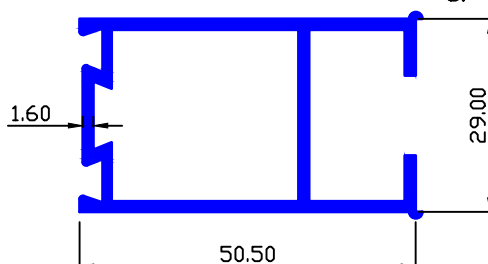

MAAN SEC.-89402 0.622 Kg/Mtr.

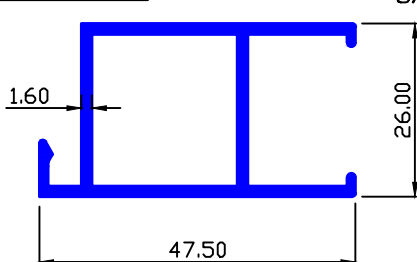

MAAN SEC.-89406 0.799 Kg/Mtr.

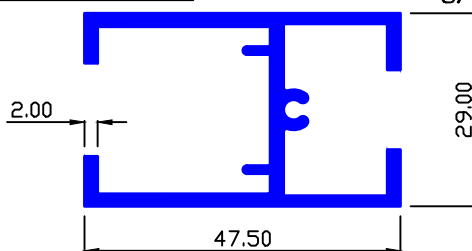

MAAN SEC.-89404

1.180 Kg/Mtr.

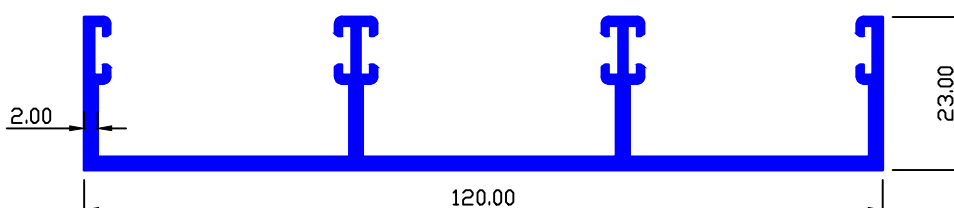



SLIDING WINDOW

MAAN SEC.-89412

0.937 Kg/Mtr.

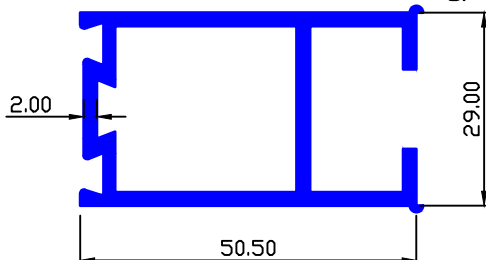

MAAN SEC.-89413

0.717 Kg/Mtr.

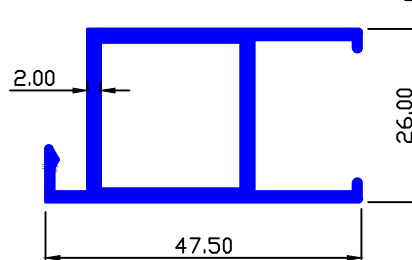

MAAN SEC.-89414

0.893 Kg/Mtr.

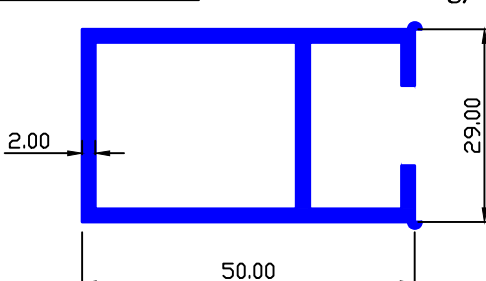

MAAN SEC.-89415

1.233 Kg/Mtr.

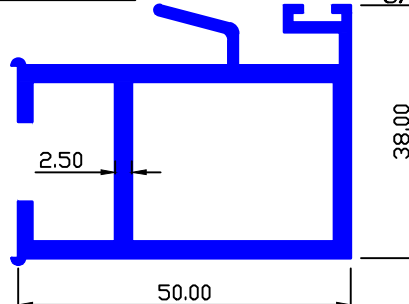

MAAN SEC.-89529

1.400 Kg/Mtr.

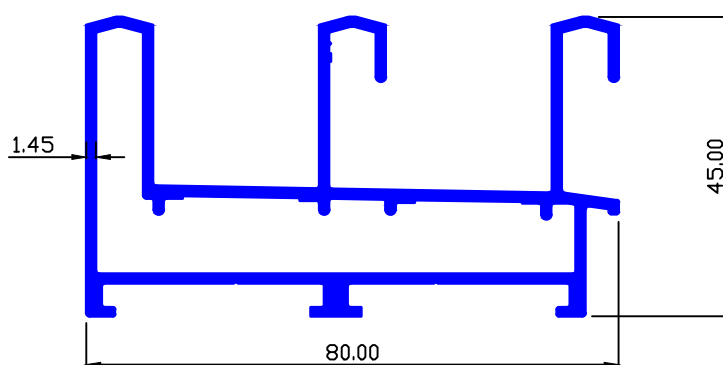

MAAN SEC.-89531

1.261 Kg/Mtr.

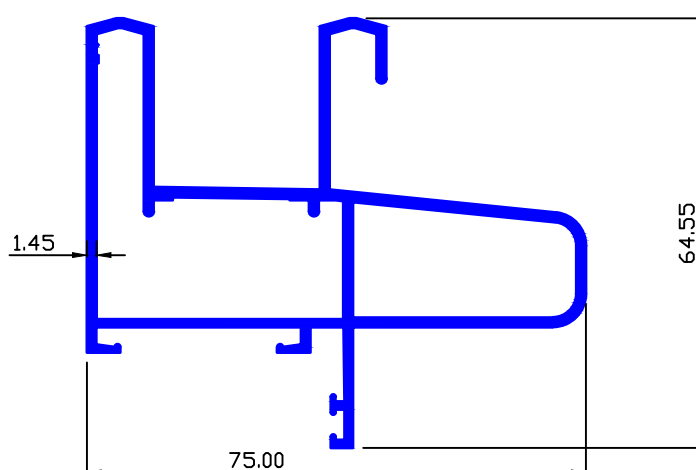



SLIDING WINDOW

MAAN SEC.-89530

1.985 Kg/Mtr.

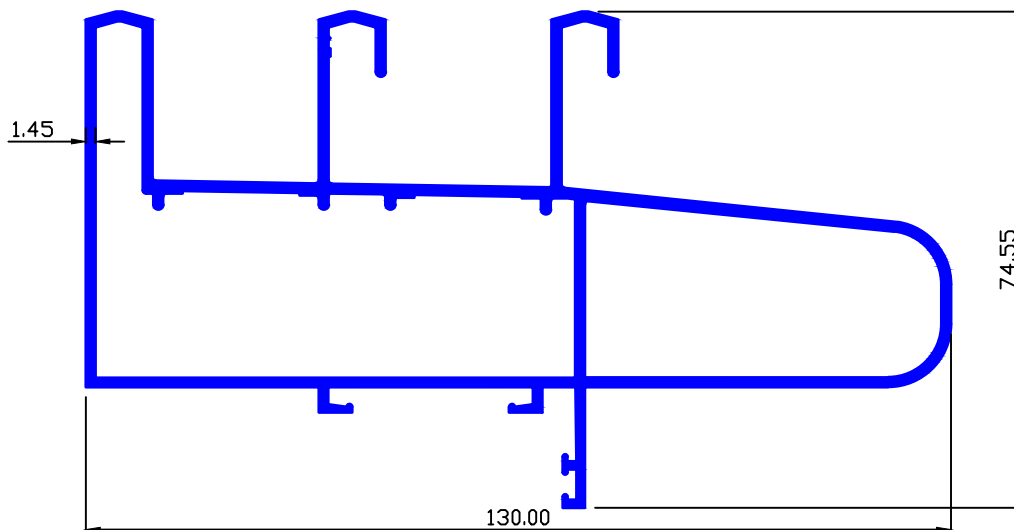

MAAN SEC.-89533

0.335 Kg/Mtr.

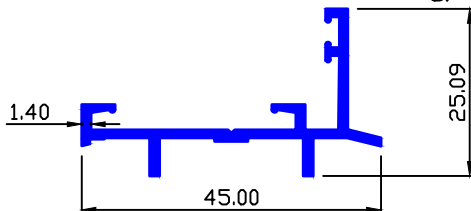

MAAN SEC.-89544

0.470 Kg/Mtr.

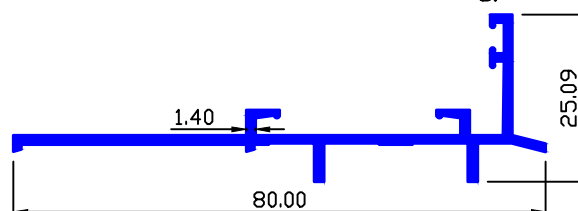

MAAN SEC.-89566

0.775 Kg/Mtr.

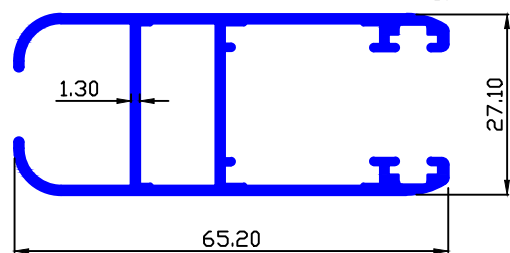

MAAN SEC.-89567

0.280 Kg/Mtr.

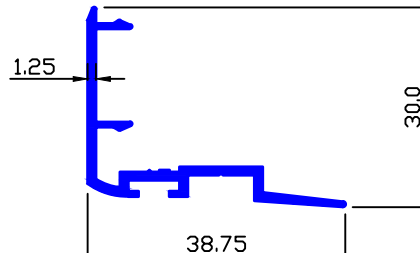

MAAN SEC.-89731

1.674 Kg/Mtr.

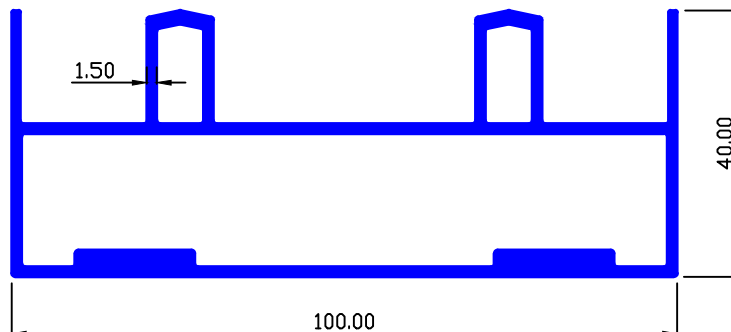



SLIDING WINDOW

MAAN SEC.-89732

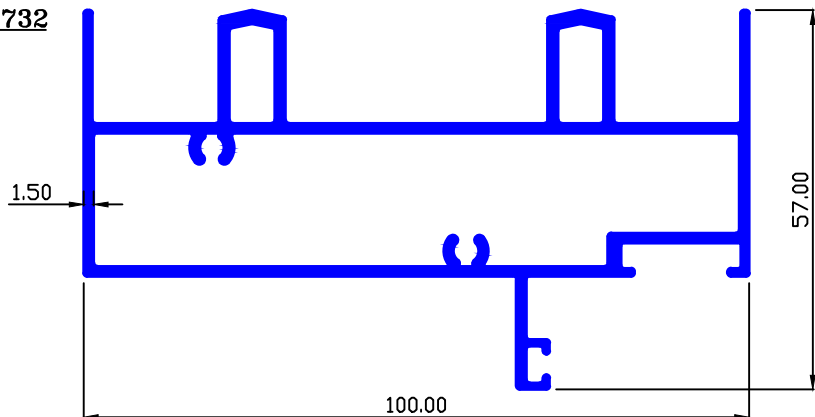

1.657 Kg/Mtr.

MAAN SEC.-89747

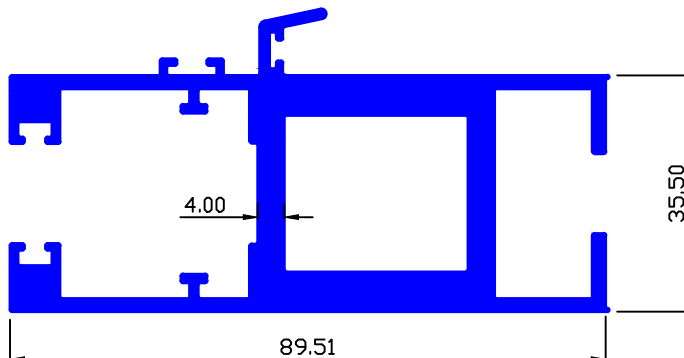

2.804 Kg/Mtr.

MAAN SEC.-89748

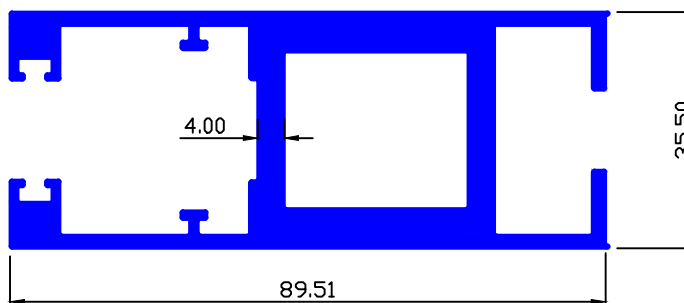

2.700 Kg/Mtr.

MAAN SEC.-89757

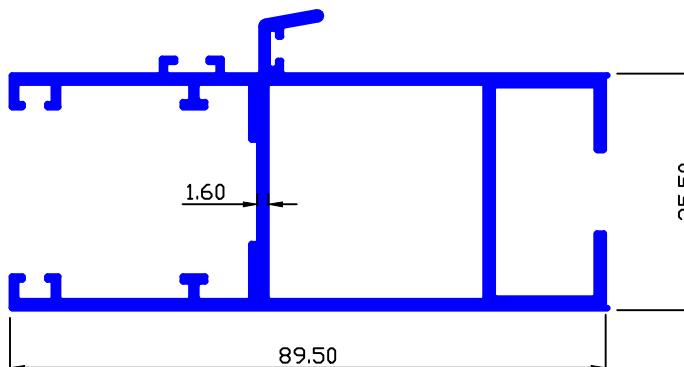

1.433 Kg/Mtr.



SLIDING WINDOW

MAAN SEC.-89758

1.332 Kg/Mtr.

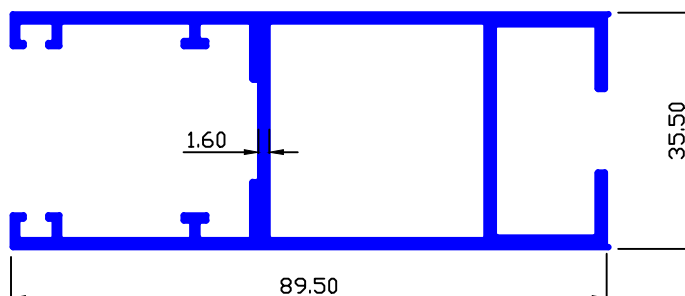

MAAN SEC.-89759

1.763 Kg/Mtr.

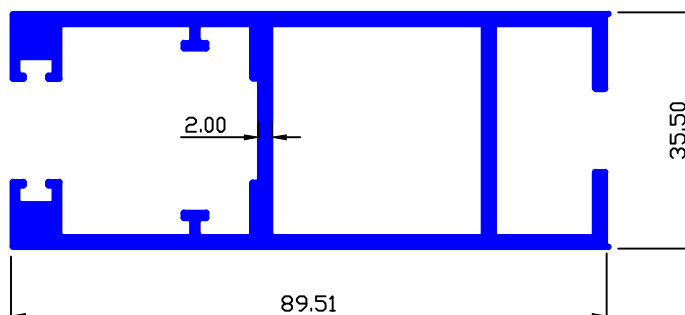

MAAN SEC.-89760

2.539 Kg/Mtr.

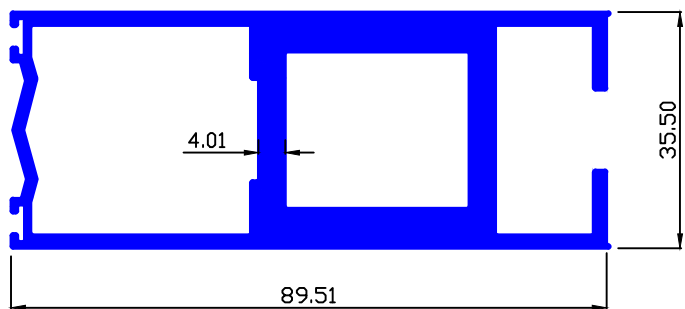

MAAN SEC.-89778

0.580 Kg/Mtr.

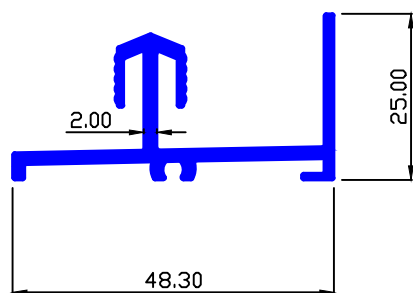

MAAN SEC.-89790

1.024 Kg/Mtr.

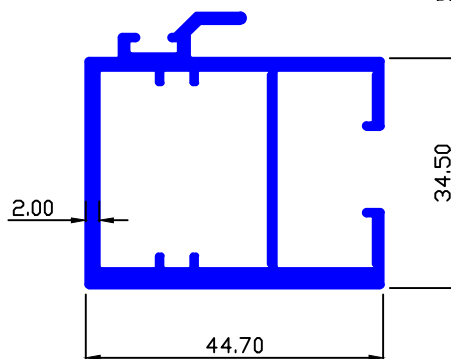



SLIDING WINDOW

MAAN SEC.-89793

1.014 Kg/Mtr.

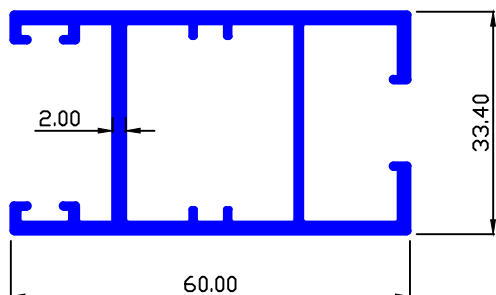

MAAN SEC.-89839

0.869 Kg/Mtr.

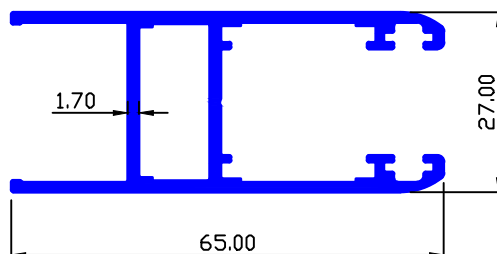

MAAN SEC.-89892

0.509 Kg/Mtr.

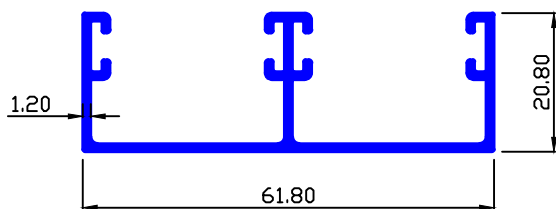

MAAN SEC.-89893

0.585 Kg/Mtr.

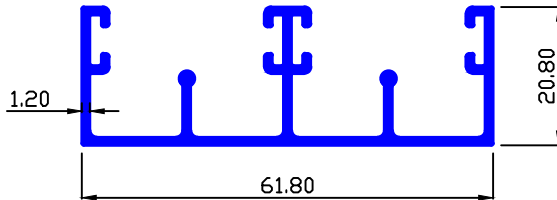

MAAN SEC.-89895

1.371 Kg/Mtr.

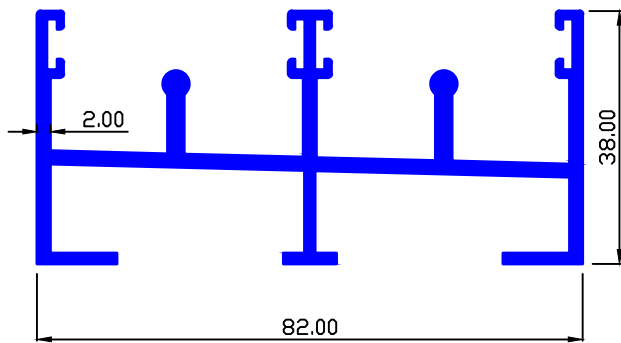

MAAN SEC.-89896

1.179 Kg/Mtr.

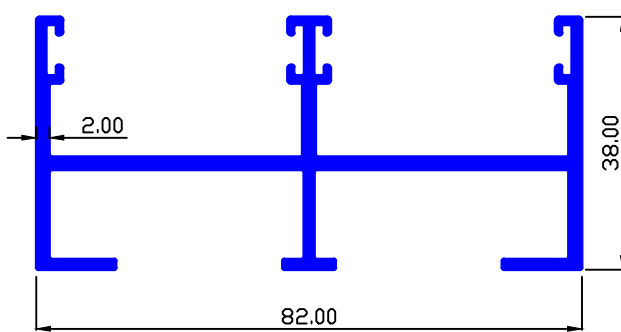

MAAN SEC.-89902

0.997 Kg/Mtr.

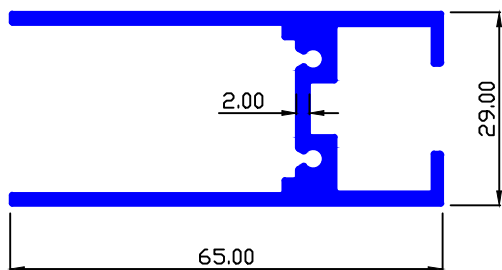

MAAN SEC.-89905

0.403 Kg/Mtr.

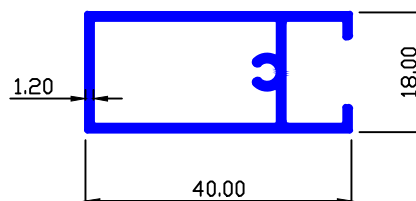



SLIDING WINDOW

MAAN SEC.-89906

0.508 Kg/Mtr.

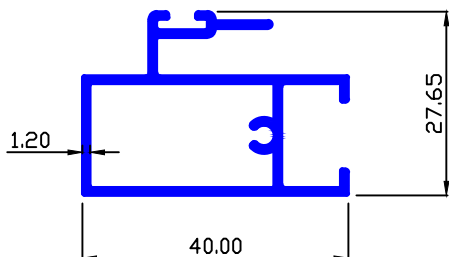

MAAN SEC.-89907

0.435 Kg/Mtr.

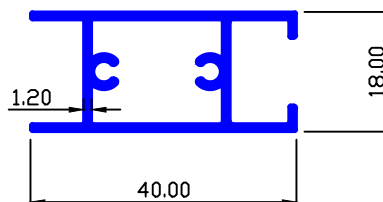

MAAN SEC.-89908

0.513 Kg/Mtr.

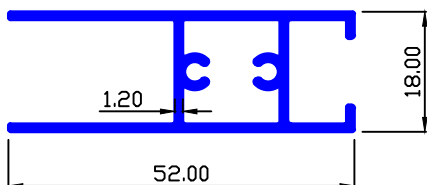

MAAN SEC.-89910

0.880 Kg/Mtr.

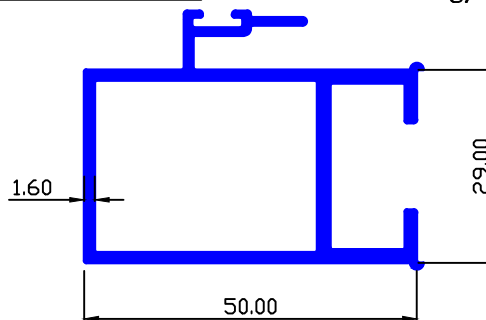

MAAN SEC.-89909

0.513 Kg/Mtr.

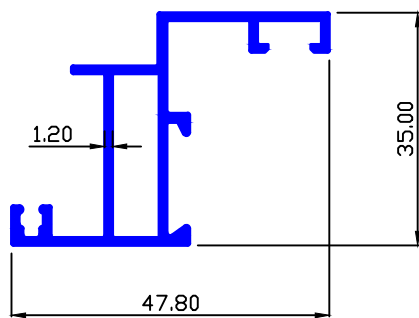

MAAN SEC.-89911

0.777 Kg/Mtr.

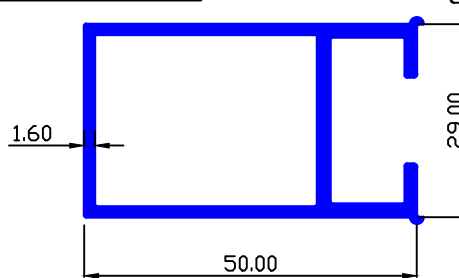

MAAN SEC.-89912

0.912 Kg/Mtr.

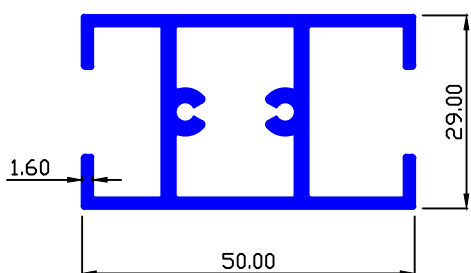

MAAN SEC.-89196

1.134 Kg/Mtr.

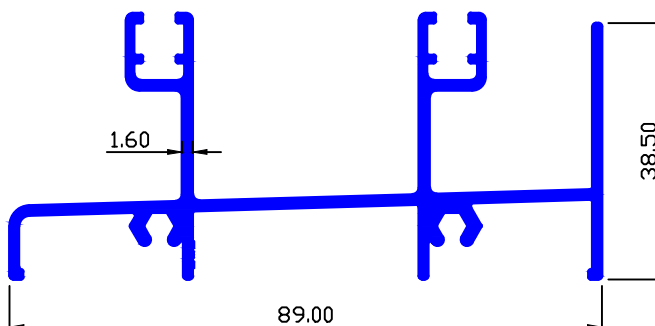



SLIDING WINDOW

MAAN SEC.-6779

0.933 Kg/Mtr.

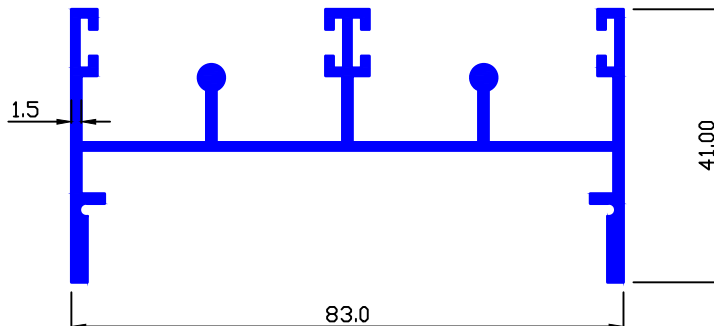

MAAN SEC.-6780

0.912 Kg/Mtr.

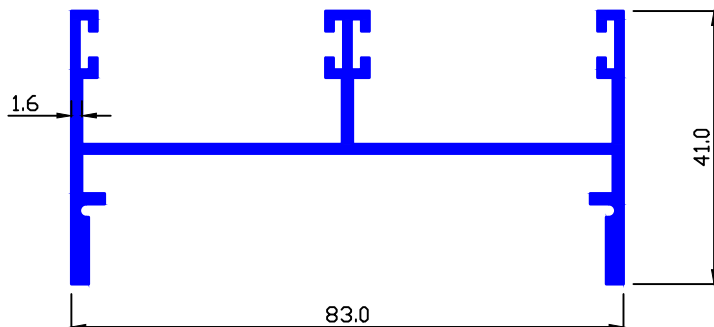

MAAN SEC.-6781

0.820 Kg/Mtr.

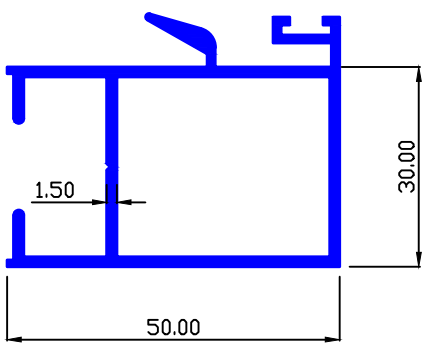

MAAN SEC.-6783

0.694 Kg/Mtr.

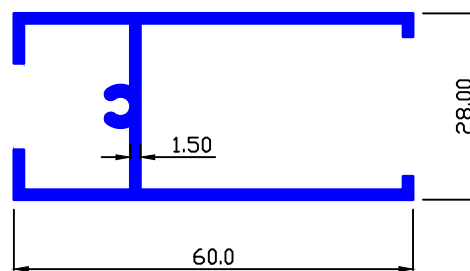

MAAN SEC.-6782

0.638 Kg/Mtr.

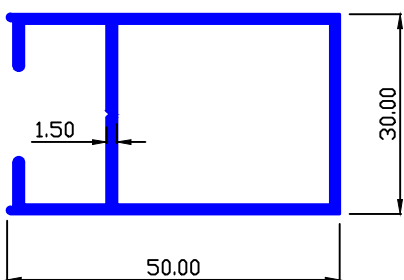

MAAN SEC.-6793

0.702 Kg/Mtr.

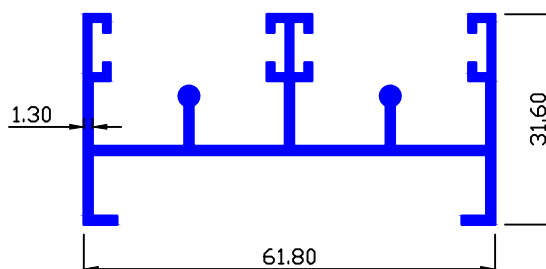



SLIDING WINDOW

MAAN SEC.-7023

1.670 Kg/Mtr.

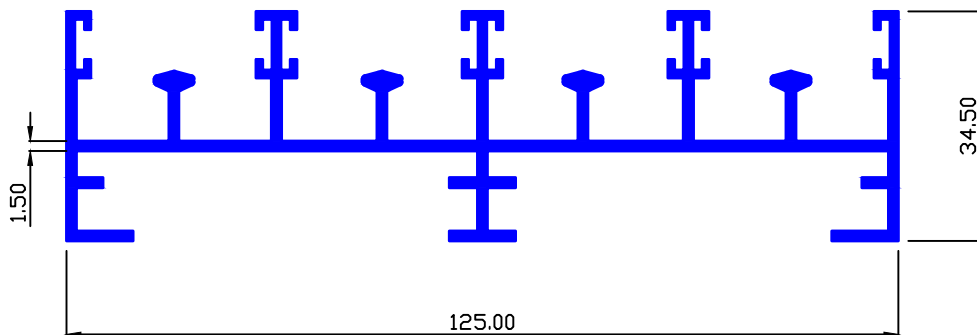

MAAN SEC.-7029

0.460 Kg/Mtr.

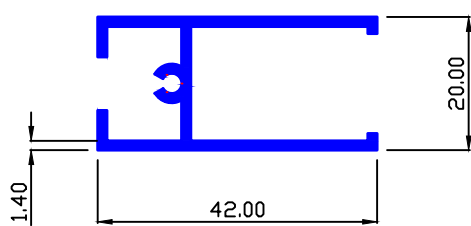

MAAN SEC.-7031

0.610 Kg/Mtr.

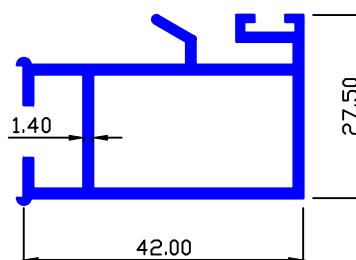

MAAN SEC.-7030

0.495 Kg/Mtr.

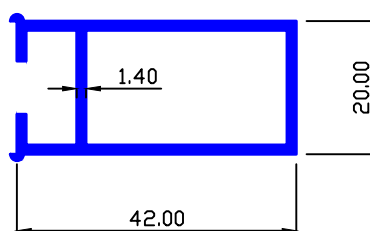

MAAN SEC.-7032

0.970 Kg/Mtr.

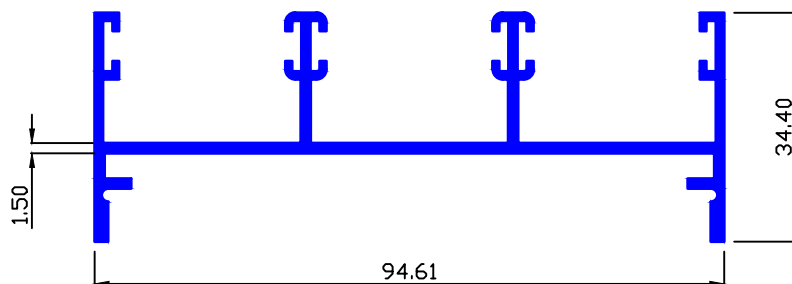



SLIDING WINDOW

MAAN SEC.-7033

1.130 Kg/Mtr.

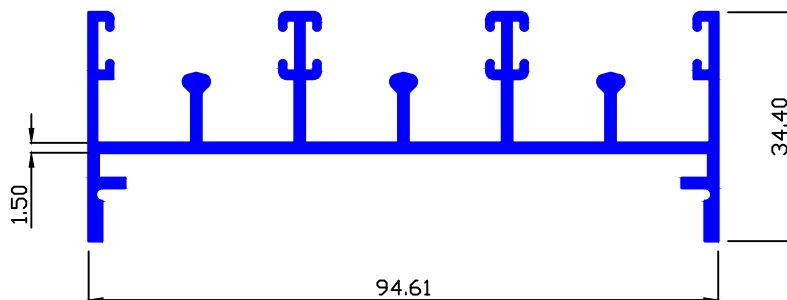

MAAN SEC.-7075

0.500 Kg/Mtr.

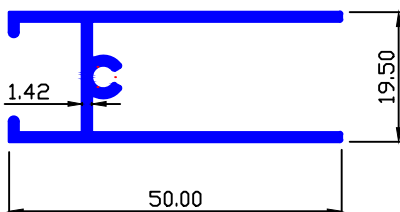

MAAN SEC.-7601

0.697 Kg/Mtr.

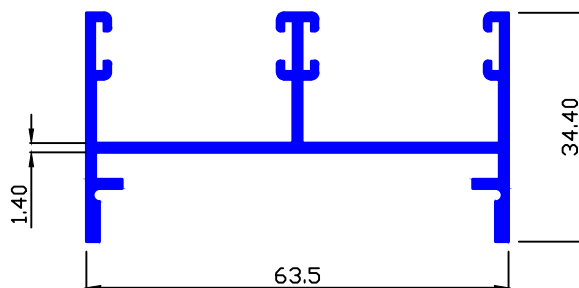

MAAN SEC.-7076

0.500 Kg/Mtr.

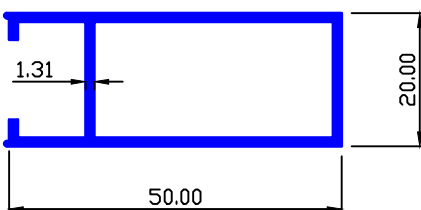

MAAN SEC.-7602

0.797 Kg/Mtr.

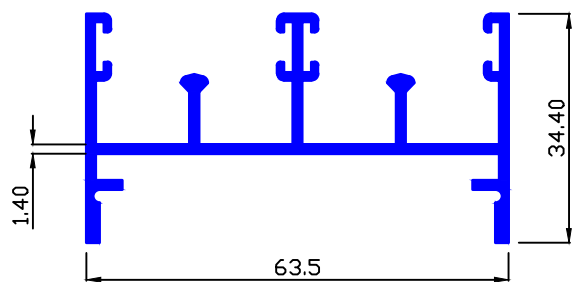

MAAN SEC.-7077

0.650 Kg/Mtr.

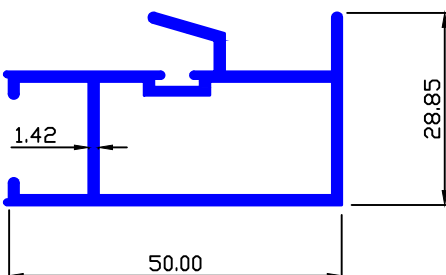

MAAN SEC.-8016

0.616 Kg/Mtr.

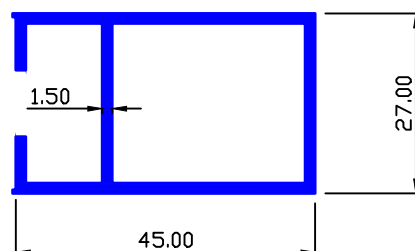



SLIDING WINDOW

MAAN SEC.-8019

0.816 Kg/Mtr.

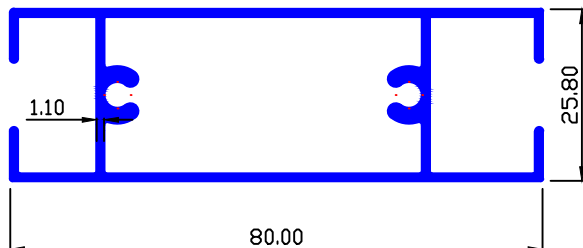

MAAN SEC.-8031

0.520 Kg/Mtr.

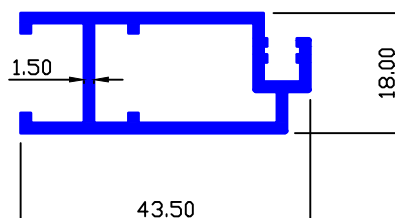

MAAN SEC.-8020

1.035 Kg/Mtr.

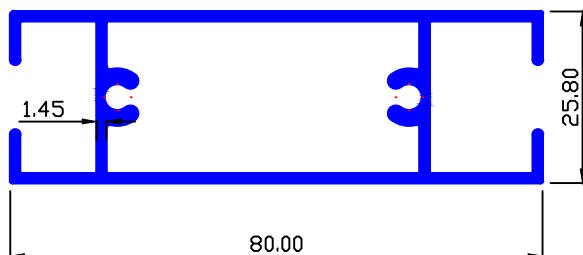

MAAN SEC.-8017

0.756 Kg/Mtr.

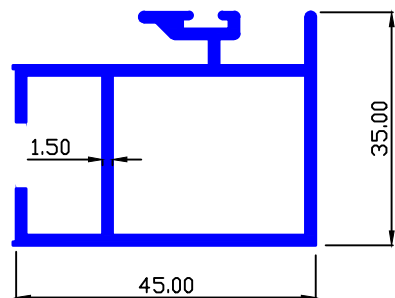

MAAN SEC.-8030

1.696 Kg/Mtr.

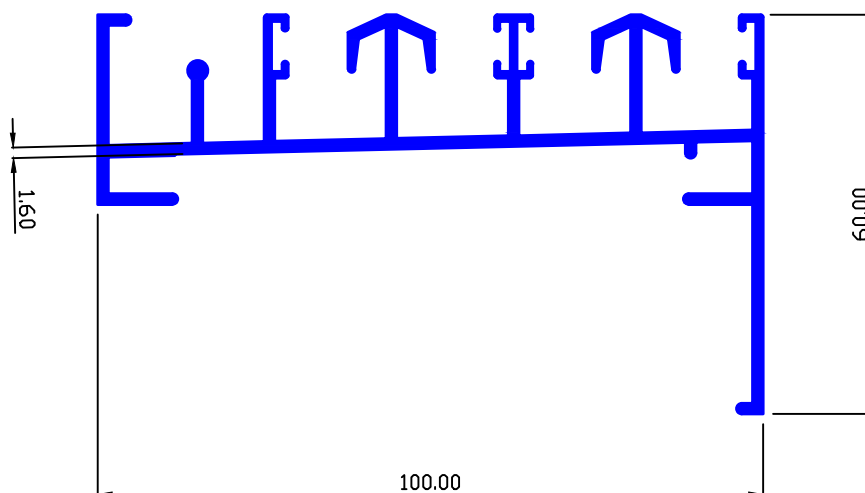



SLIDING WINDOW

MAAN SEC.-8018

0.620 Kg/Mtr.

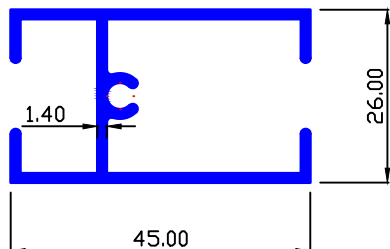

MAAN SEC.-8046

0.560 Kg/Mtr.

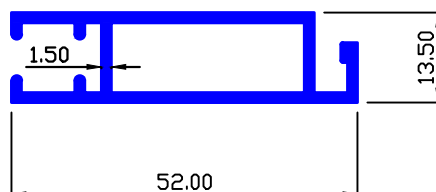

MAAN SEC.-8040

0.913 Kg/Mtr.

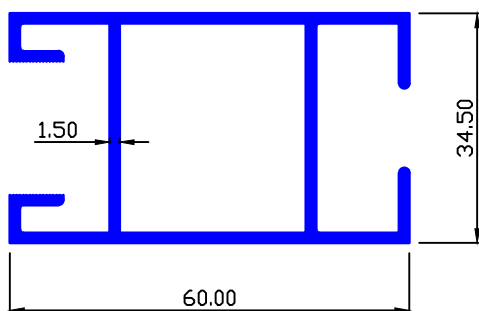

MAAN SEC.-8049

0.820 Kg/Mtr.

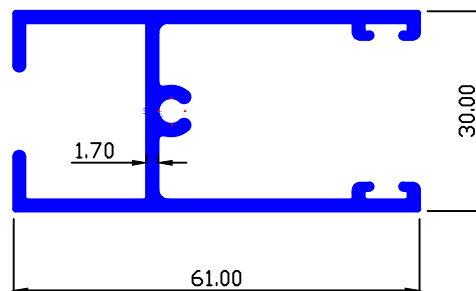

MAAN SEC.-8045

1.800 Kg/Mtr.

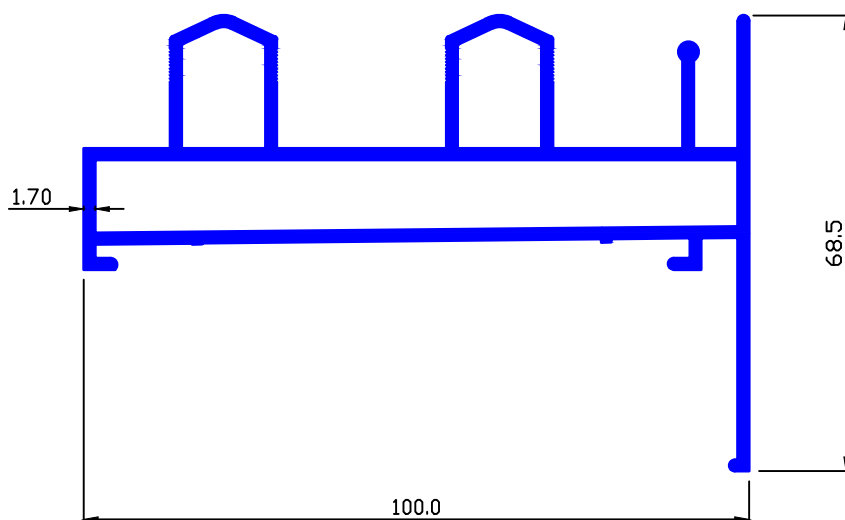



SLIDING WINDOW

MAAN SEC.-8050 0.972 Kg/Mtr.

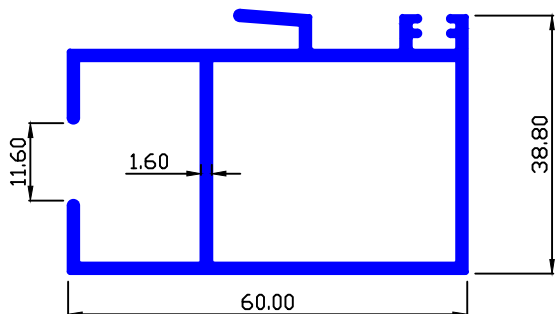

MAAN SEC.-8098 0.590 Kg/Mtr.

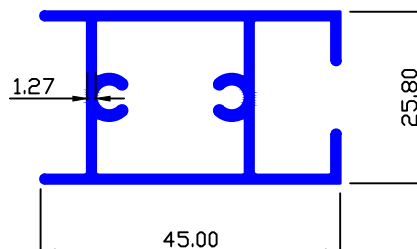

MAAN SEC.-8068

1.116 Kg/Mtr.

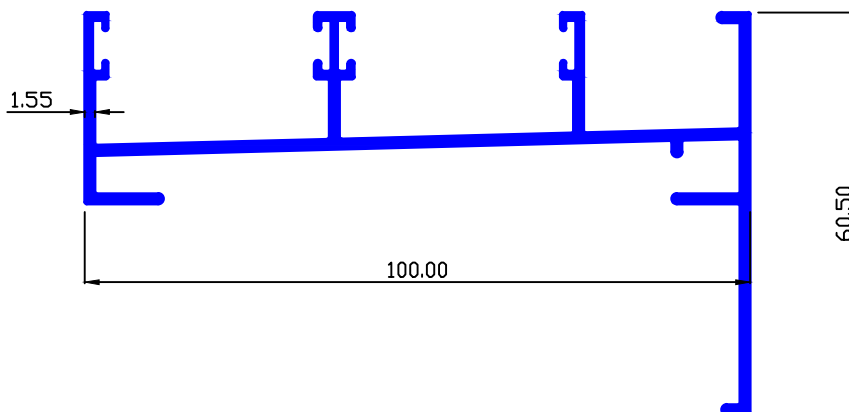

MAAN SEC.-8073

0.455 Kg/Mtr.

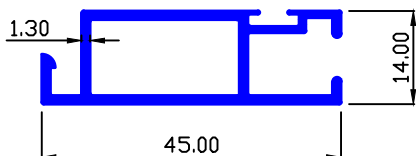

MAAN SEC.-8070

1.006 Kg/Mtr.

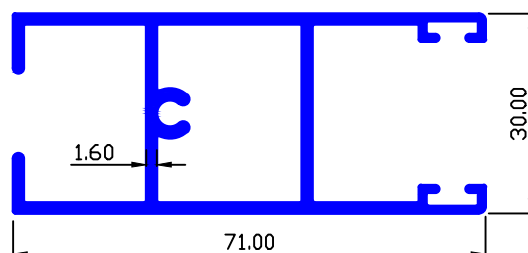

MAAN SEC.-8062

0.495 Kg/Mtr.

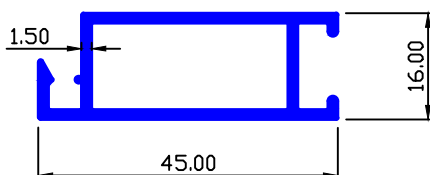

SEC. NO.-90372

WT.-0.071 Kg/Mtr.

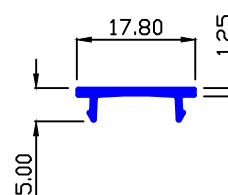



SLIDING WINDOW

MAAN SEC.-90213

1.342 Kg/Mtr.

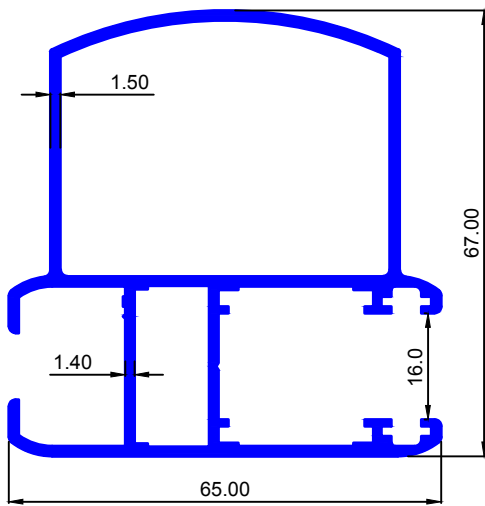

MAAN SEC.-90140

0.619 Kg/Mtr.

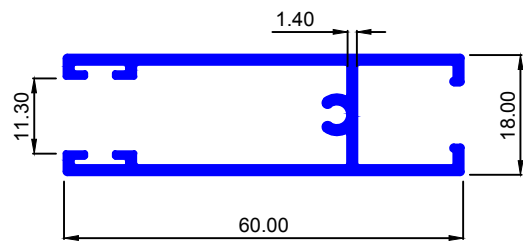

MAAN SEC.-90098

0.970 Kg/Mtr.

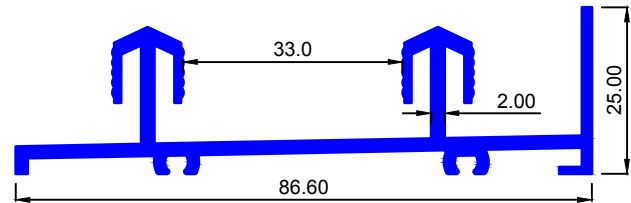

MAAN SEC.-90074

1.196 Kg/Mtr.

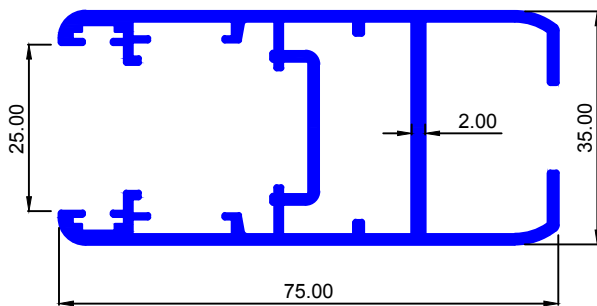

MAAN SEC.-90149

0.382 Kg/Mtr.

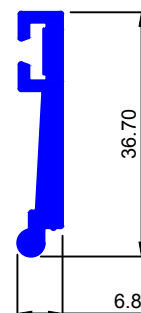

MAAN SEC.-90147

0.658 Kg/Mtr.

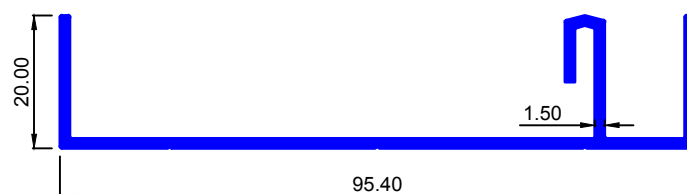



MAAN ALUMINIUM LTD.

SLWI-042

SLIDING WINDOW

MAAN SEC.-8526

0.491 Kg/Mtr.

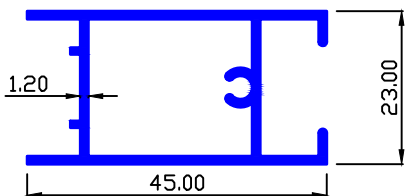

MAAN SEC.-8517/L

0.286 Kg/Mtr.

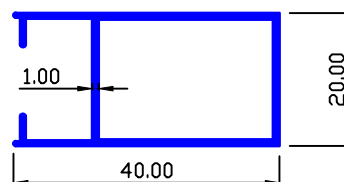

MAAN SEC.-8100

1.509 Kg/Mtr.

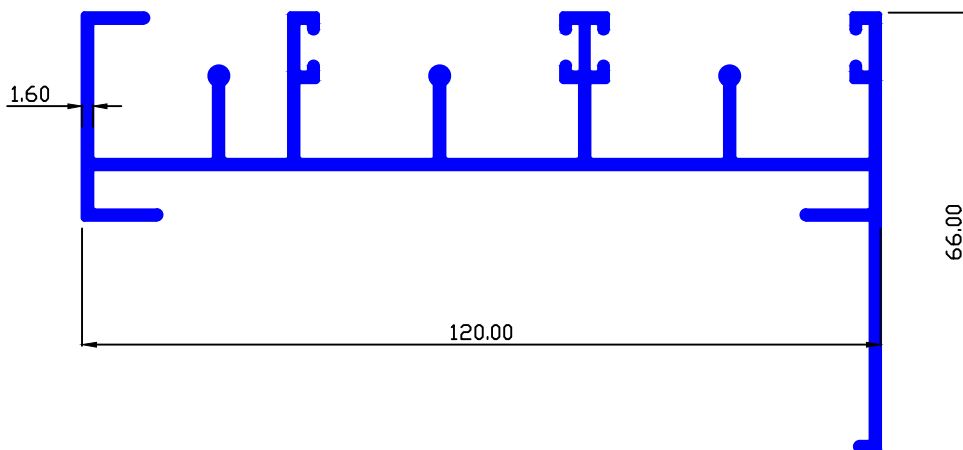

MAAN SEC.-8514/L

0.680 Kg/Mtr.

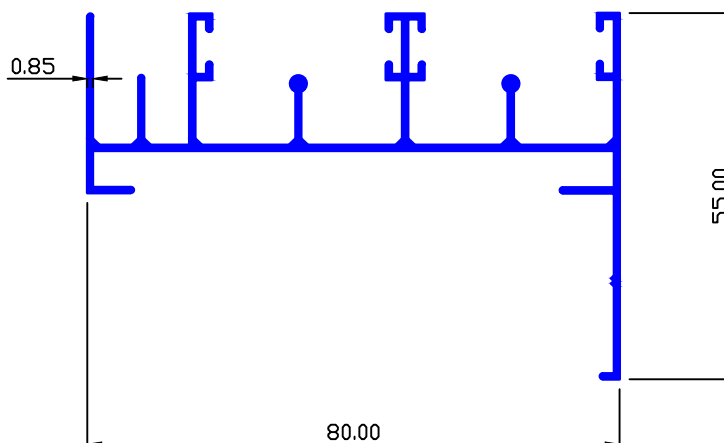



SLIDING WINDOW

MAAN SEC.-8515/L

0.577 Kg/Mtr.

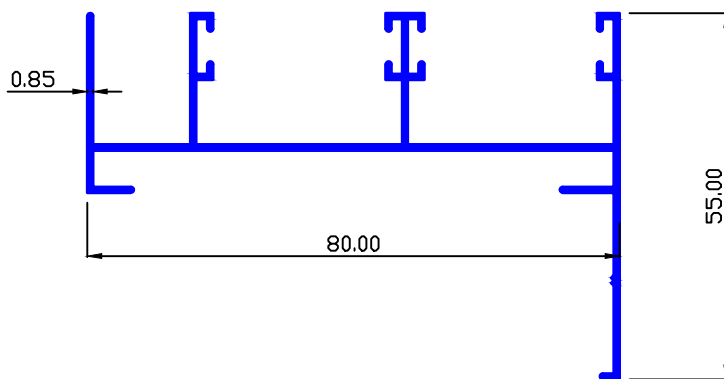

MAAN SEC.-8516

0.578 Kg/Mtr.

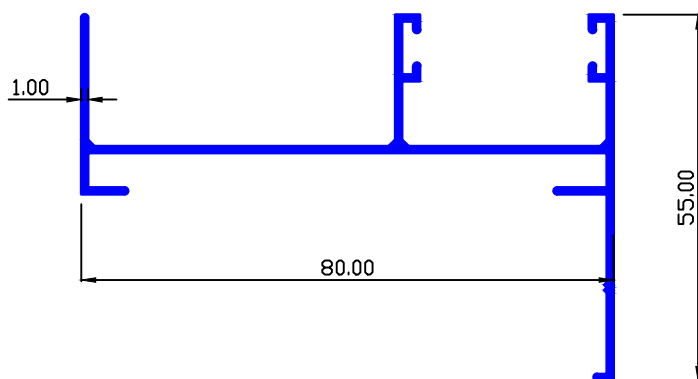

MAAN SEC.-8518/L

0.336 Kg/Mtr.

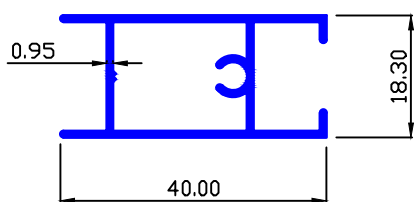

MAAN SEC.-8520/L

0.194 Kg/Mtr.

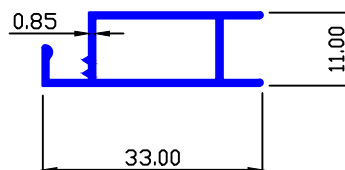

MAAN SEC.-8519/L

0.320 Kg/Mtr.

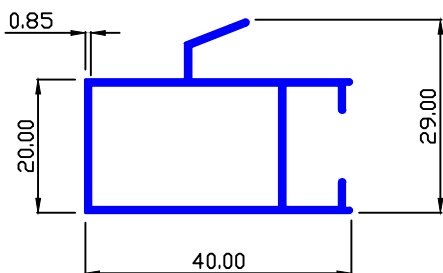

MAAN SEC.-8525

0.330 Kg/Mtr.

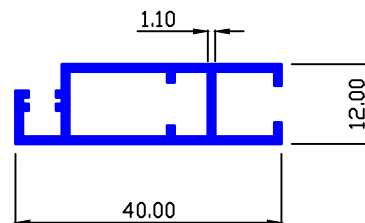



SLIDING WINDOW

MAAN SEC.-90370

1.691 Kg/Mtr.

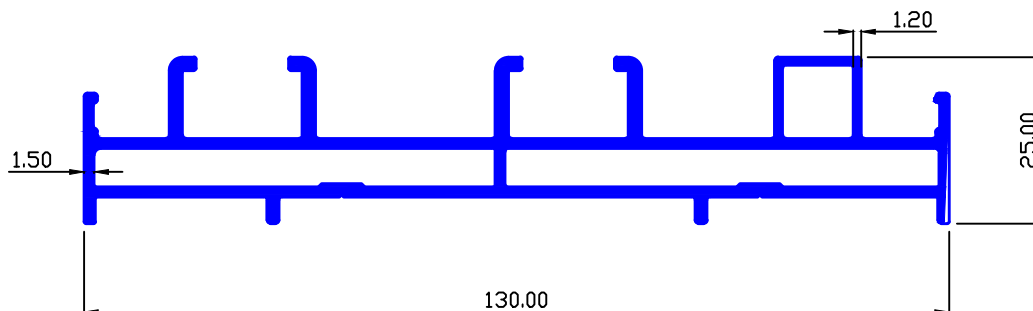

MAAN SEC.-90369

2.046 Kg/Mtr.

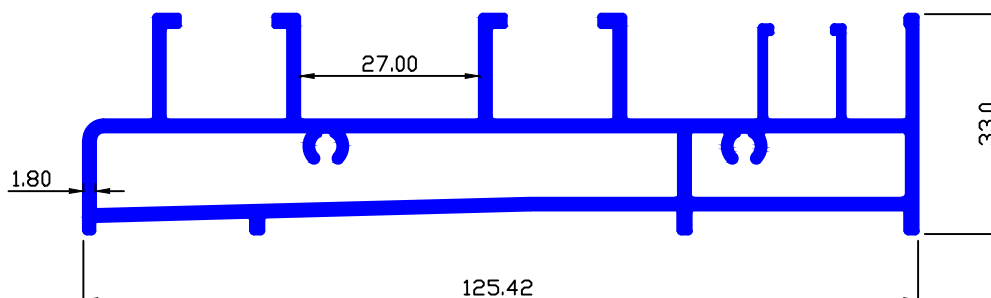

MAAN SEC.-90367

0.633 Kg/Mtr.

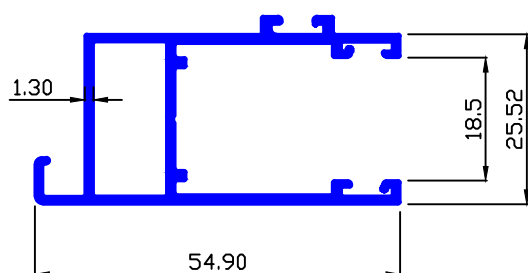

MAAN SEC.-8527

0.560 Kg/Mtr.

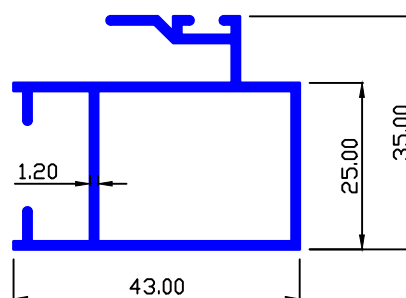

MAAN SEC.-8529

0.518 Kg/Mtr.

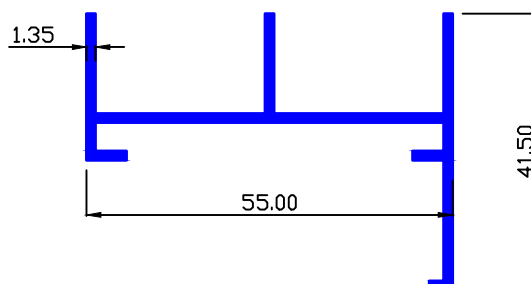



SLIDING WINDOW

MAAN SEC.-90371

0.484 Kg/Mtr.

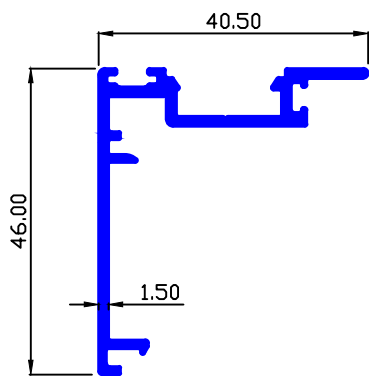

MAAN SEC.-90210

0.986 Kg/Mtr.

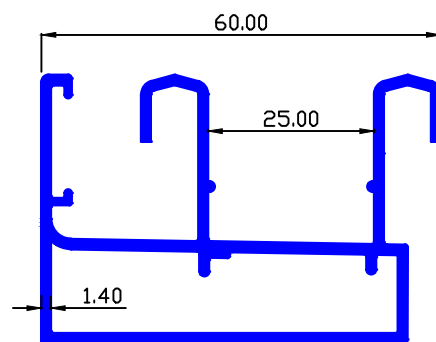

MAAN SEC.-90212

1.453 Kg/Mtr.

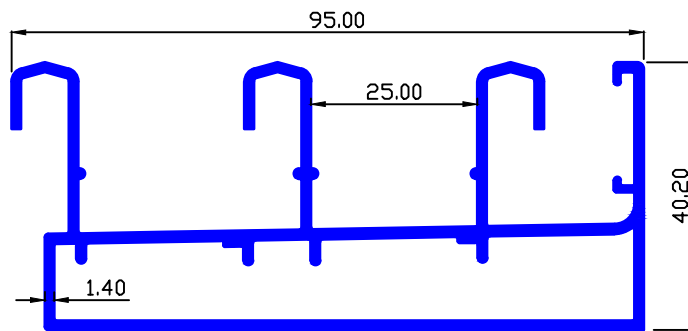

MAAN SEC.-90368

1.488 Kg/Mtr.

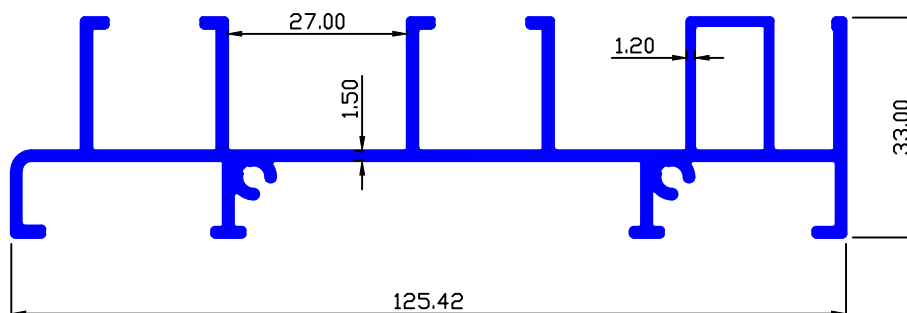



SLIDING WINDOW

MAAN SEC.-90156 **0.529 Kg/Mtr.**

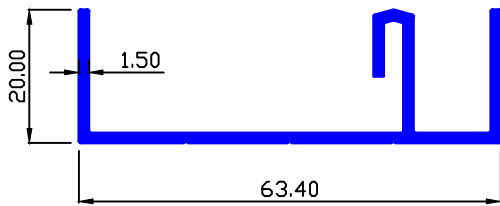

MAAN SEC.-90143 **0.769 Kg/Mtr.**

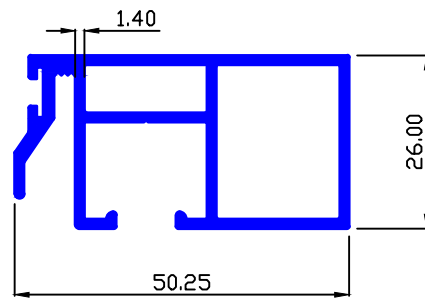

MAAN SEC.-90155 **0.723 Kg/Mtr.**

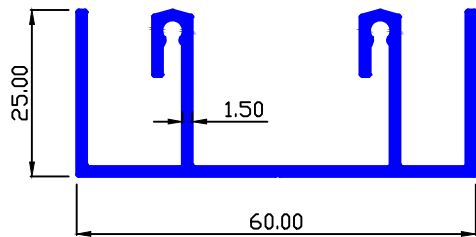

MAAN SEC.-90141 **0.590 Kg/Mtr.**

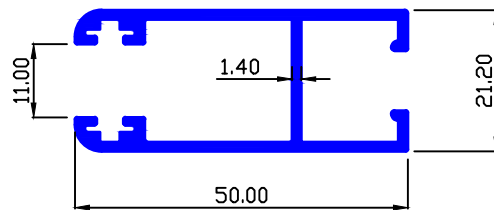

MAAN SEC.-90145 **1.005 Kg/Mtr.**

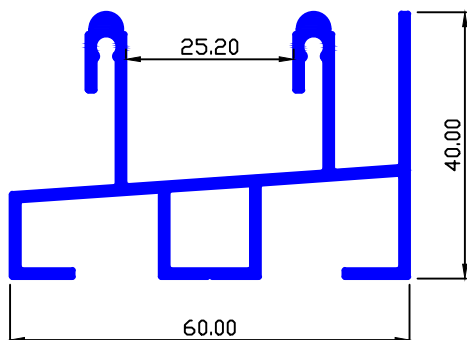

MAAN SEC.-90148 **0.861 Kg/Mtr.**

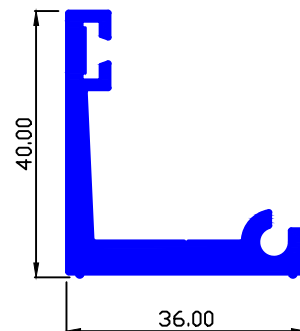



SLIDING WINDOW

MAAN SEC.-90099

1.195 Kg/Mtr.

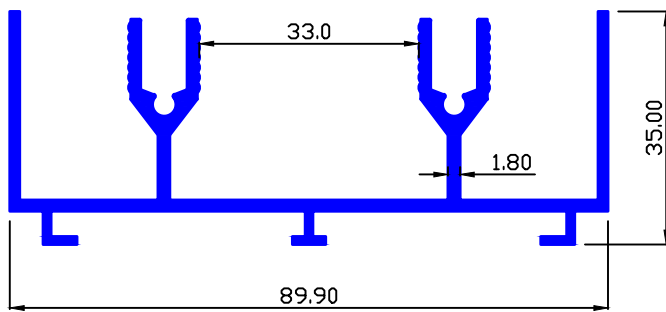

MAAN SEC.-90076

0.427 Kg/Mtr.

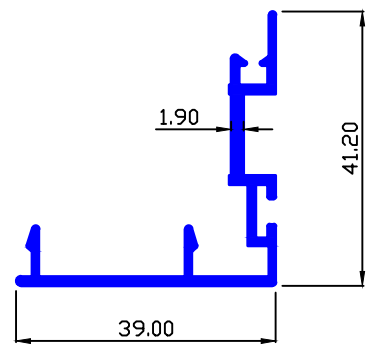

MAAN SEC.-90139

0.993 Kg/Mtr.

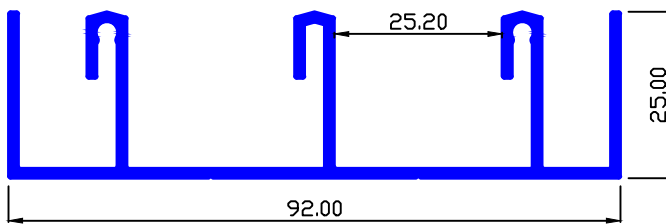

MAAN SEC.-90209

1.016 Kg/Mtr.

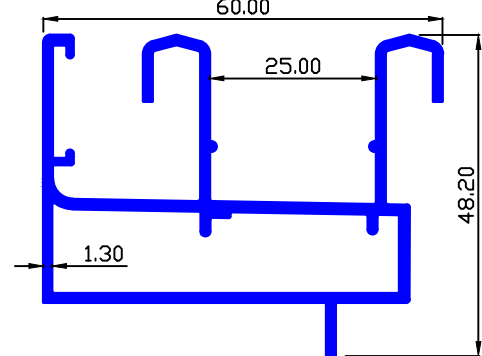

MAAN SEC.-90075

2.634 Kg/Mtr.

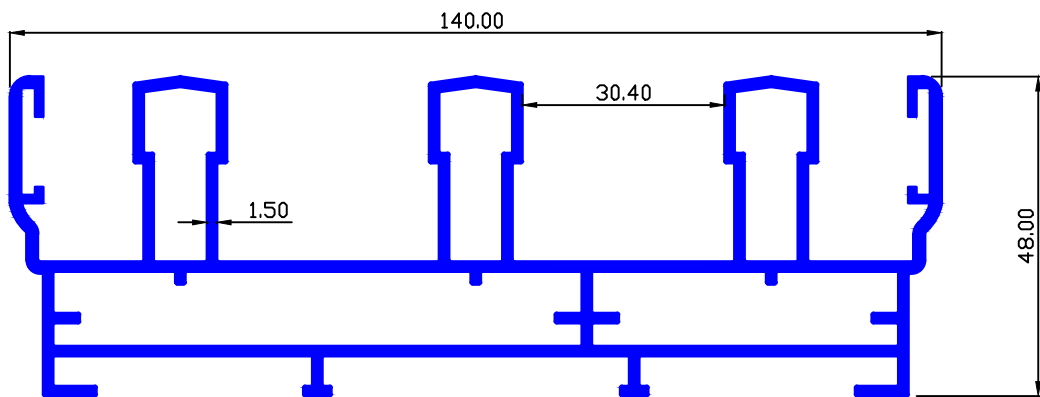



SLIDING WINDOW

MAAN SEC.-90090

0.994 Kg/Mtr.

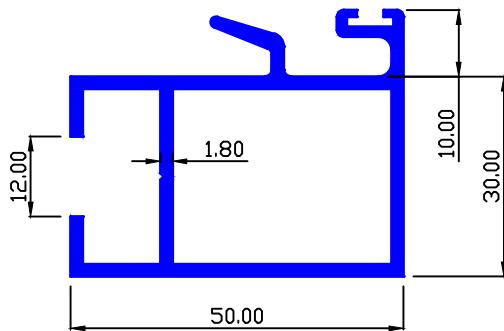

WEIGHT RANGE:- 3.400 TO 4.000 Kg/12'

MAAN SEC.-90087

0.807 Kg/Mtr.

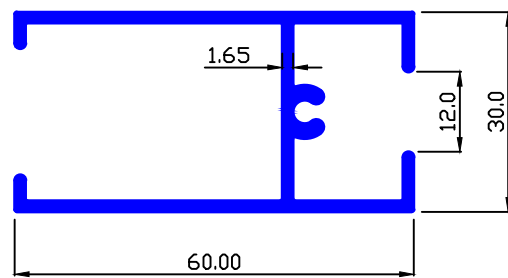

MAAN SEC.-90089

0.811 Kg/Mtr.

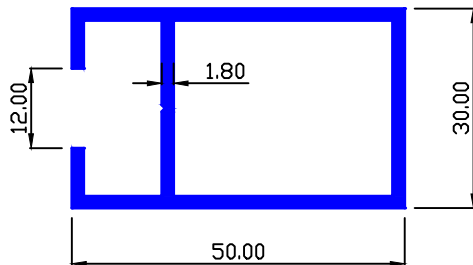

WEIGHT RANGE:- 2.700 TO 3.200 Kg/12'

MAAN SEC.-90149

0.382 Kg/Mtr.

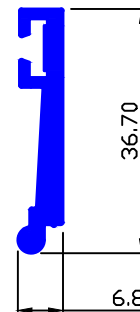

MAAN SEC.-90088

1.566 Kg/Mtr.

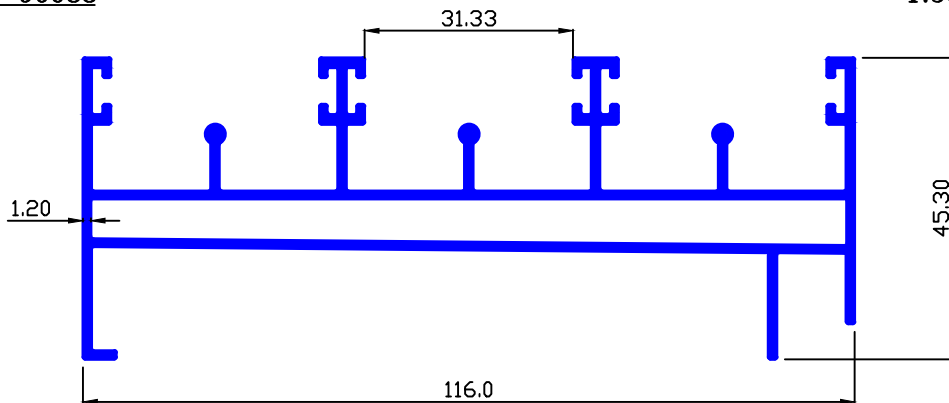

WEIGHT RANGE : 5.300 TO 6.200 Kg/12'



SLIDING WINDOW

MAAN SEC.-90086

1.193 Kg/Mtr.

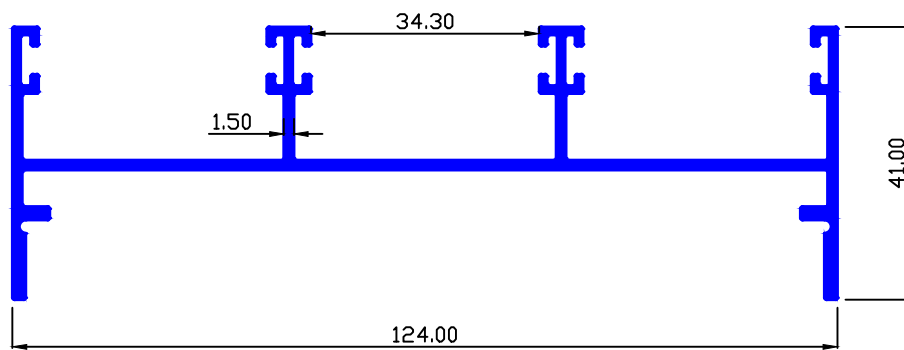

WEIGHT RANGE : 4.000 TO 4.800 Kg/12'

MAAN SEC.-90085

1.542 Kg/Mtr.

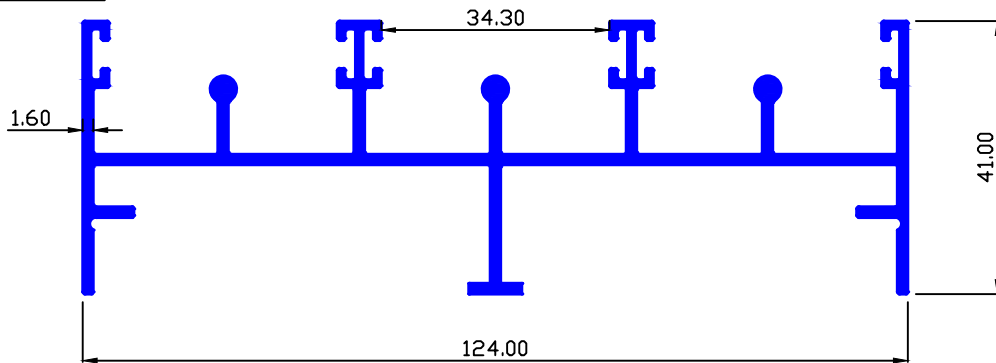

WEIGHT RANGE : 5.300 TO 6.100 Kg/12'

MAAN SEC.-89924

0.429 Kg/Mtr.

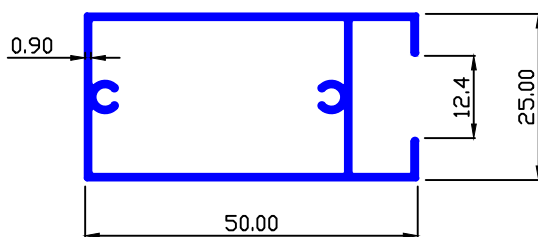

WEIGHT RANGE 1.480 TO 1.680 Kg/12'

MAAN SEC.-89923

0.437 Kg/Mtr.

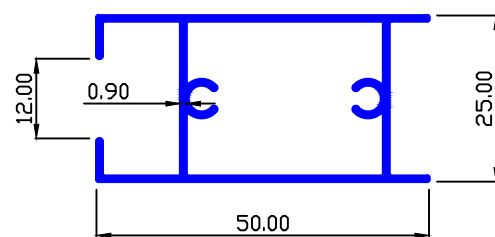



SLIDING

MAAN SEC.-89984

1.647 Kg/Mtr.

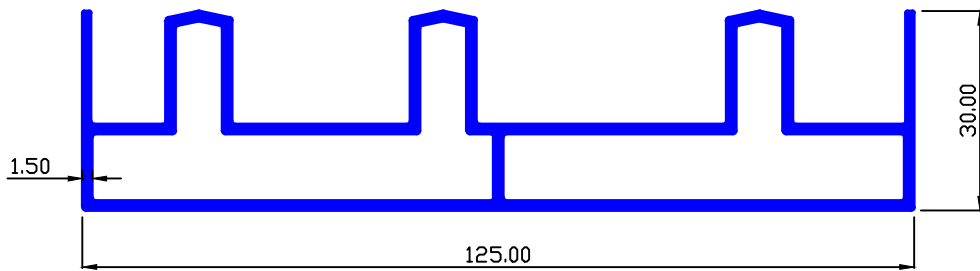

MAAN SEC.-89922

0.464 Kg/Mtr.

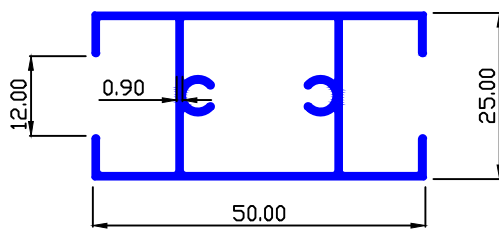

WEIGHT RANGE 1.580 TO 1.780 Kg/12'

MAAN SEC.-89917

0.808 Kg/Mtr.

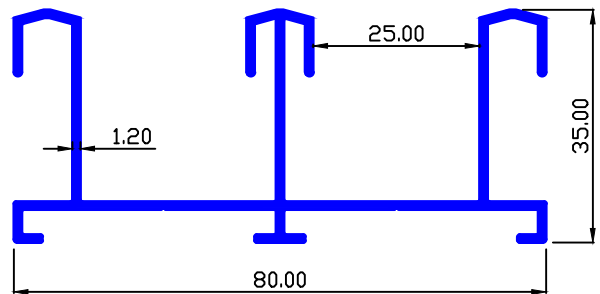

MAAN SEC.-89916

0.725 Kg/Mtr.

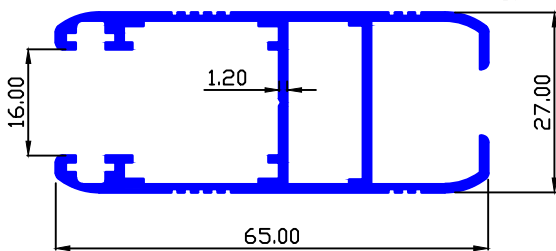

MAAN SEC.-89912

0.912 Kg/Mtr.

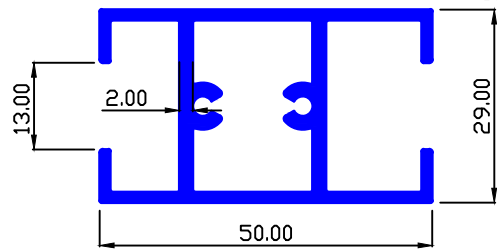

MAAN SEC.-90420

0.218 Kg/Mtr.

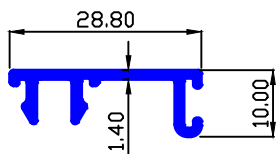

MAAN SEC.-90421

0.246 Kg/Mtr.

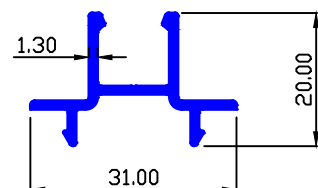



SLIDING

MAAN SEC.-90426

2.955 Kg/Mtr.

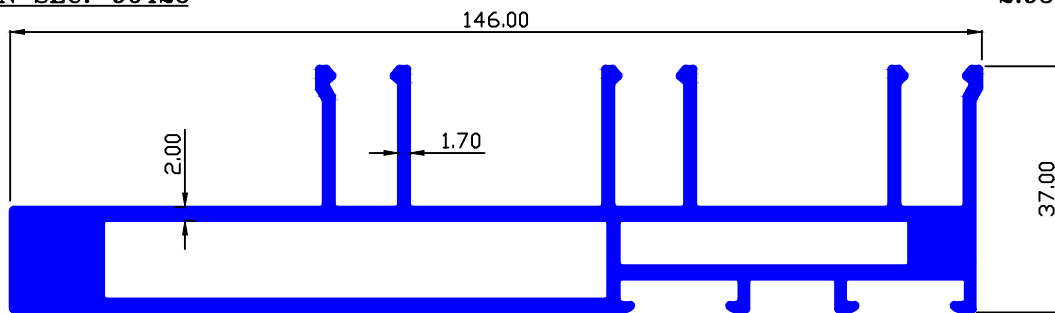

MAAN SEC.-90438

2.373 Kg/Mtr.

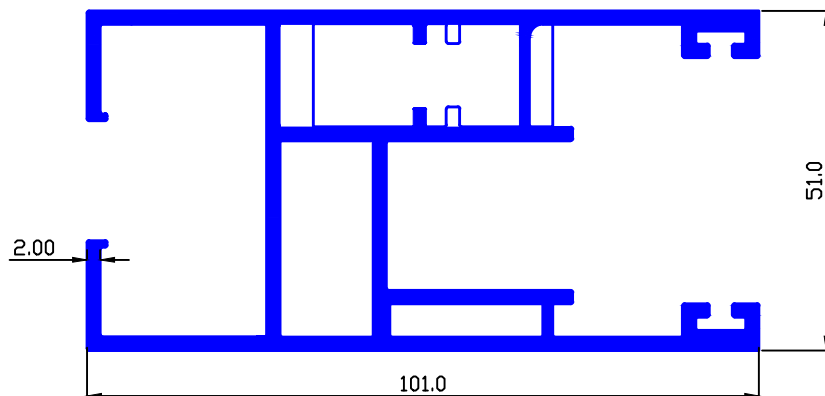

MAAN SEC.-90440

3.548 Kg/Mtr.

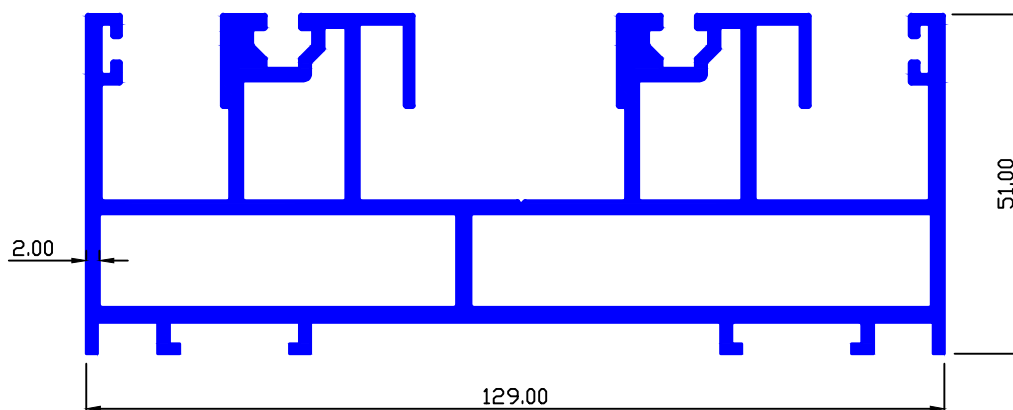



SLIDING

MAAN SEC.-90441

0.554 Kg/Mtr.

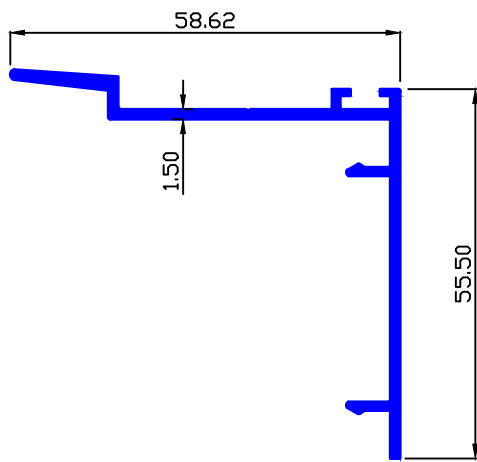

MAAN SEC.-90442

0.155 Kg/Mtr.

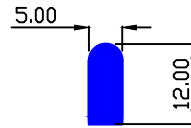

MAAN SEC.-90443

0.347 Kg/Mtr.

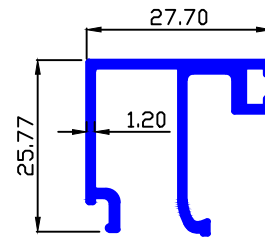

MAAN SEC.-90444

1.118 Kg/Mtr.

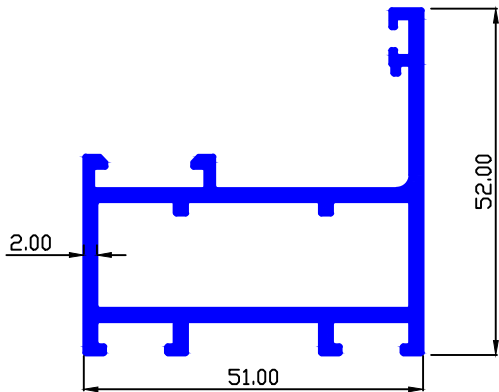

MAAN SEC.-90453

1.403 Kg/Mtr.

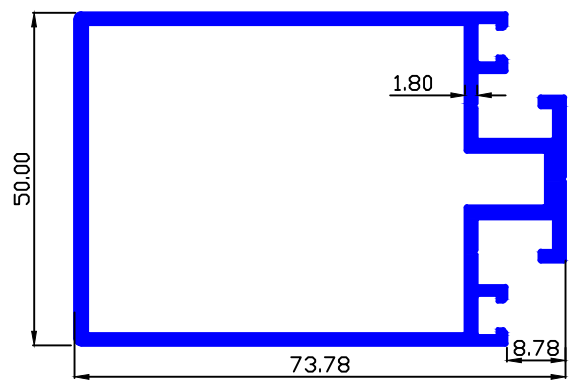

MAAN SEC.-90454

0.444 Kg/Mtr.

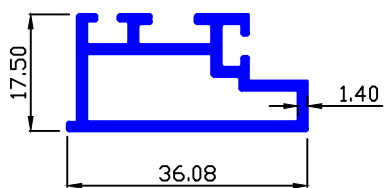

MAAN SEC.-90458

0.583 Kg/Mtr.

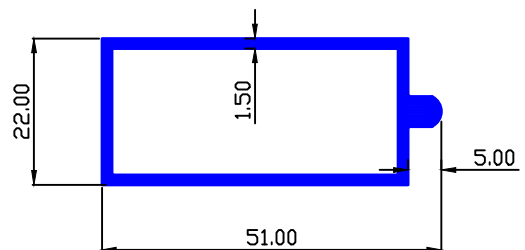



SLIDING

MAAN SEC.-90455

1.082 Kg/Mtr.

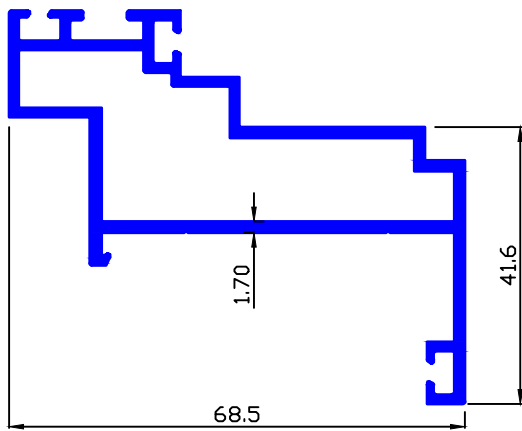

MAAN SEC.-90456

1.262 Kg/Mtr.

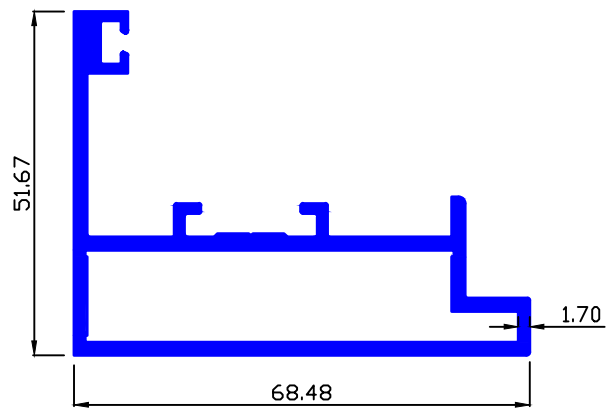

MAAN SEC.-90463

1.220 Kg/Mtr.

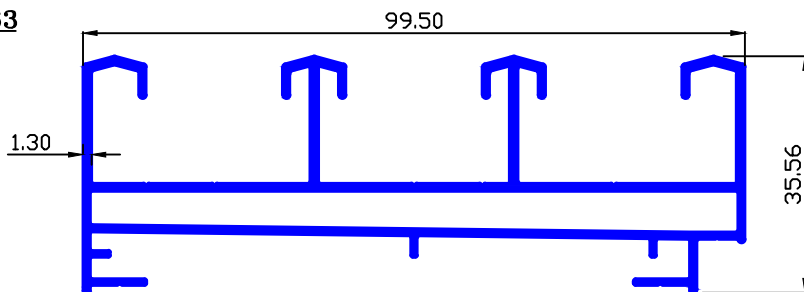

MAAN SEC.-90464

0.909 Kg/Mtr.

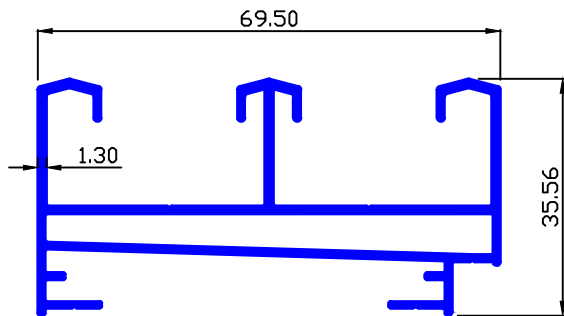

MAAN SEC.-90465

0.600 Kg/Mtr.

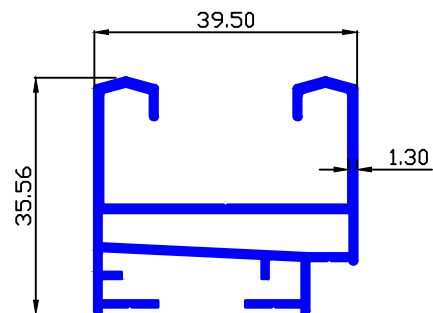



SLIDING

MAAN SEC.-90466

0.516 Kg/Mtr.

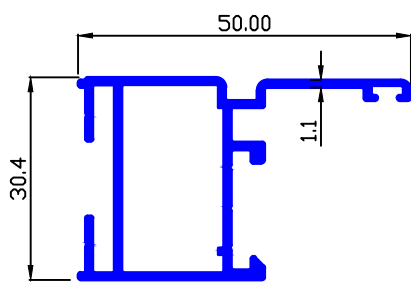

MAAN SEC.-90467

0.676 Kg/Mtr.

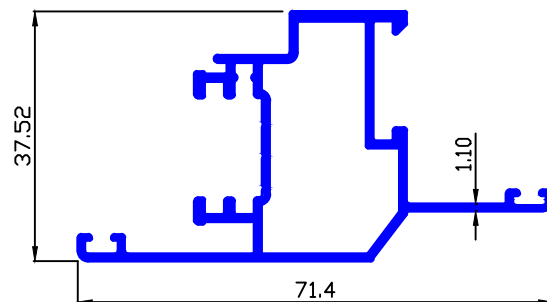

MAAN SEC.-90468

0.613 Kg/Mtr.

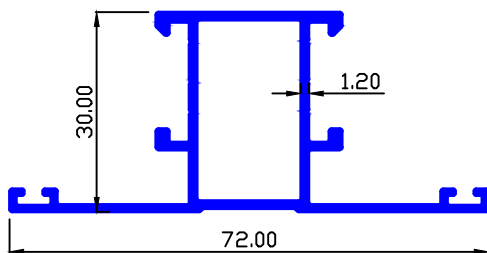

MAAN SEC.-90471

0.473 Kg/Mtr.

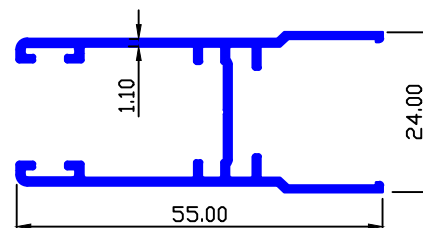

MAAN SEC.-90557

0.084 Kg/Mtr.

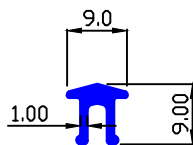

MAAN SEC.-90472

0.204 Kg/Mtr.

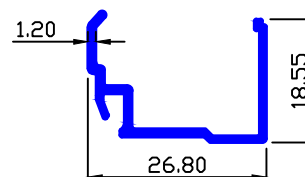

MAAN SEC.-90470

0.211 Kg/Mtr.

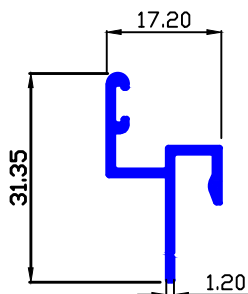

MAAN SEC.-90473

0.202 Kg/Mtr.

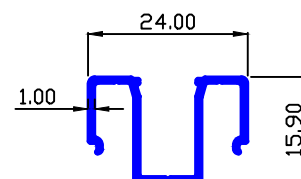



SLIDING

MAAN SEC.-90487

1.429 Kg/Mtr.

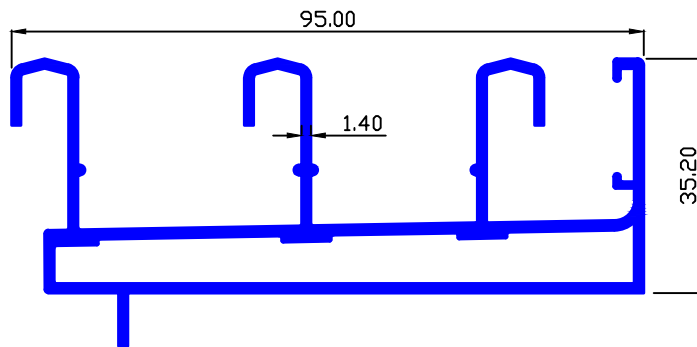

MAAN SEC.-90488

1.398 Kg/Mtr.

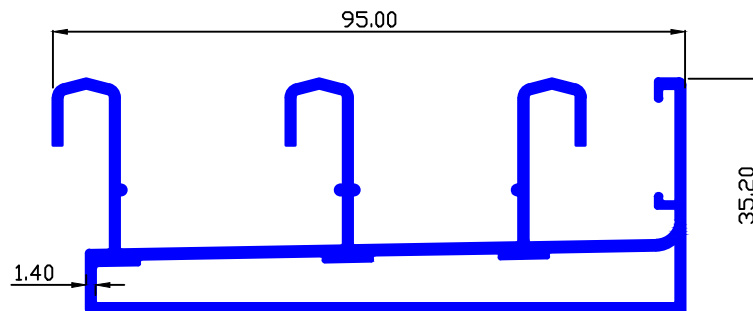

MAAN SEC.-90504

0.627 Kg/Mtr.

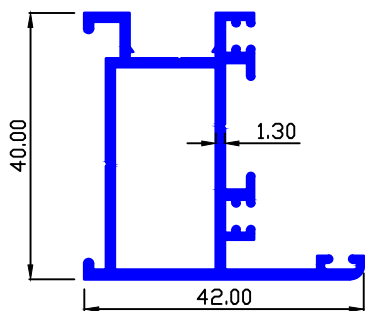

MAAN SEC.-90544

0.842 Kg/Mtr.

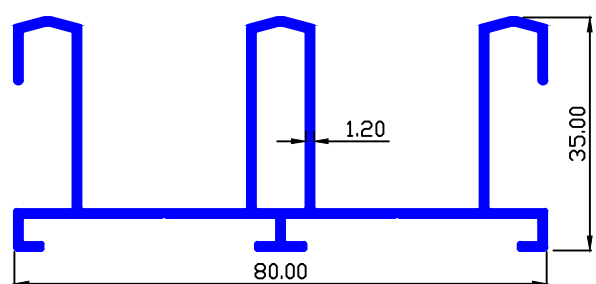

MAAN SEC.-90474

0.224 Kg/Mtr.

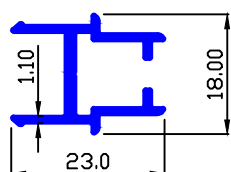

MAAN SEC.-90547

0.545 Kg/Mtr.

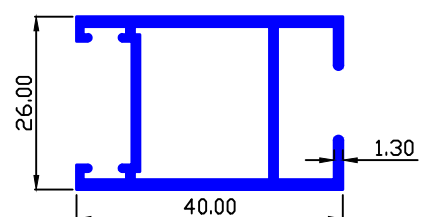



SLIDING

MAAN SEC.-90545

1.035 Kg/Mtr.

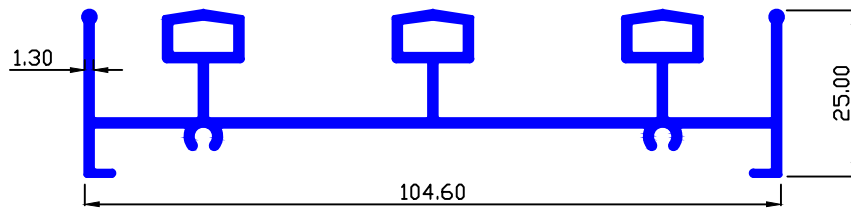

MAAN SEC.-90550

0.673 Kg/Mtr.

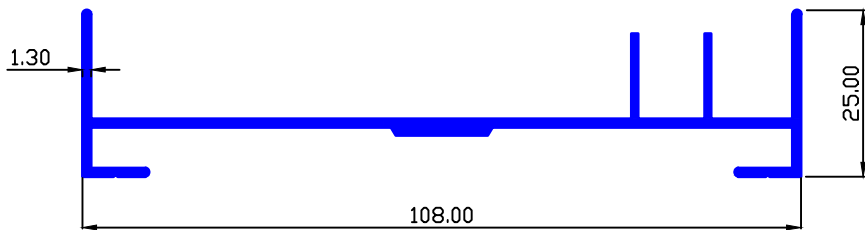

MAAN SEC.-90546

0.770 Kg/Mtr.

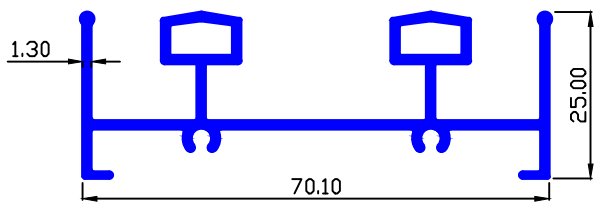

MAAN SEC.-90549

0.552 Kg/Mtr.

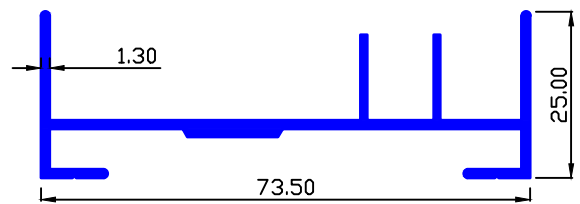

MAAN SEC.-90548

0.635 Kg/Mtr.

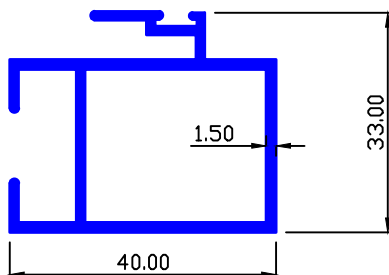

MAAN SEC.-90551

0.518 Kg/Mtr.

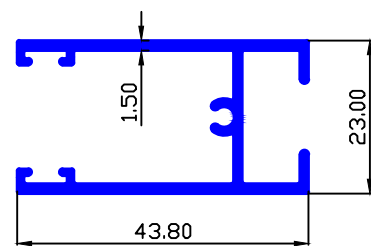



SLIDING

MAAN SEC.-90552

1.147 Kg/Mtr.

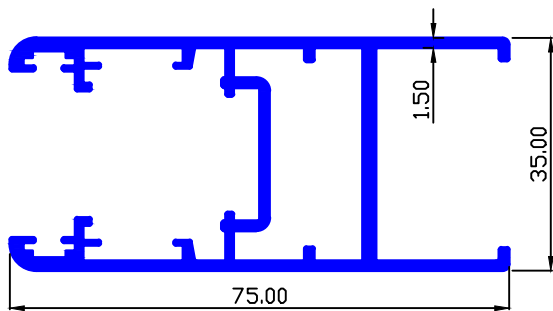

MAAN SEC.-90553

1.111 Kg/Mtr.

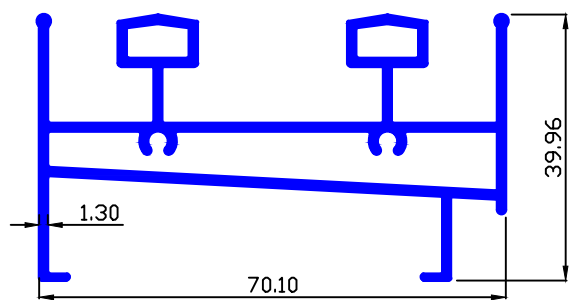

MAAN SEC.-90554

1.504 Kg/Mtr.

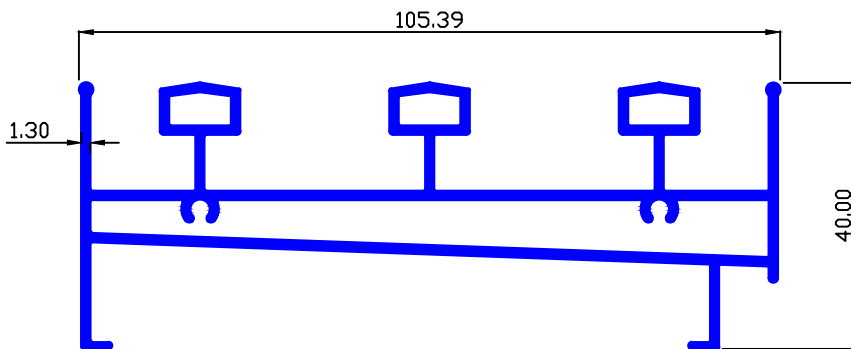

MAAN SEC.-90556

1.392 Kg/Mtr.

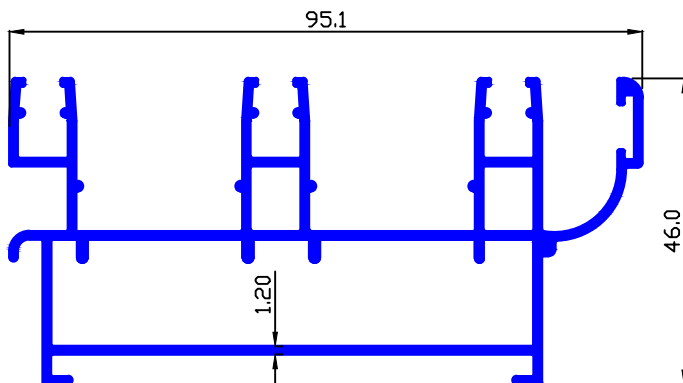



SLIDING

MAAN SEC.-90561

0.345 Kg/Mtr.

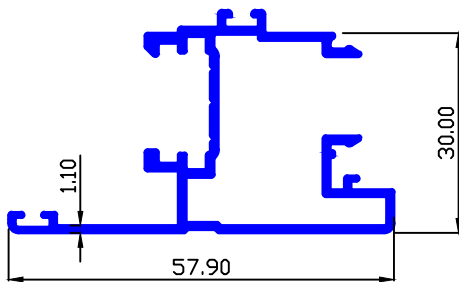

MAAN SEC.-90562

0.169 Kg/Mtr.

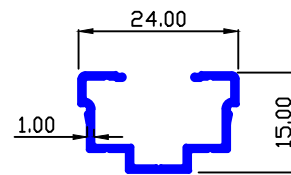

MAAN SEC.-90563

0.238 Kg/Mtr.

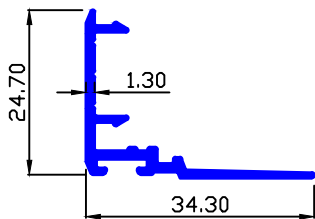

MAAN SEC.-90566

0.039 Kg/Mtr.

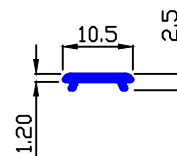

MAAN SEC.-90564

0.937 Kg/Mtr.

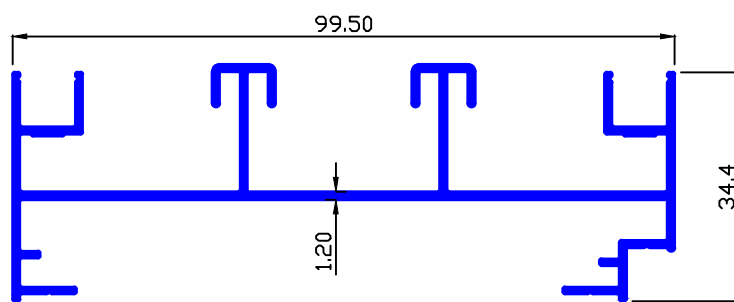

MAAN SEC.-90565

0.728 Kg/Mtr.

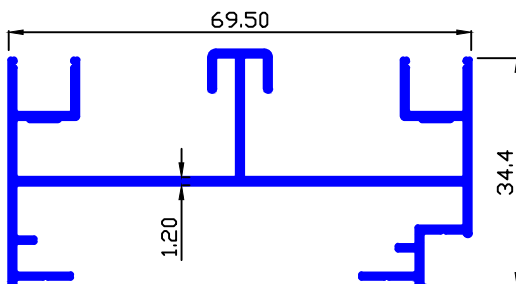

MAAN SEC.-90567

0.520 Kg/Mtr.

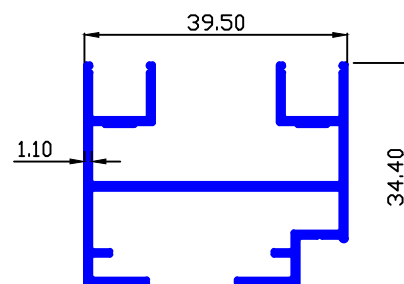



SLIDING

MAAN SEC.-90624

1.949 Kg/Mtr.

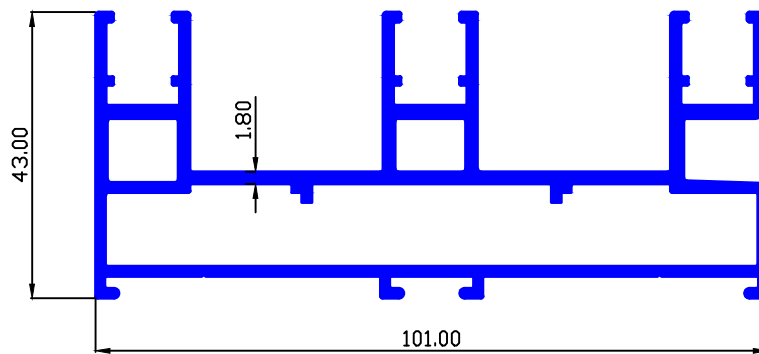

MAAN SEC.-90625

1.506 Kg/Mtr.

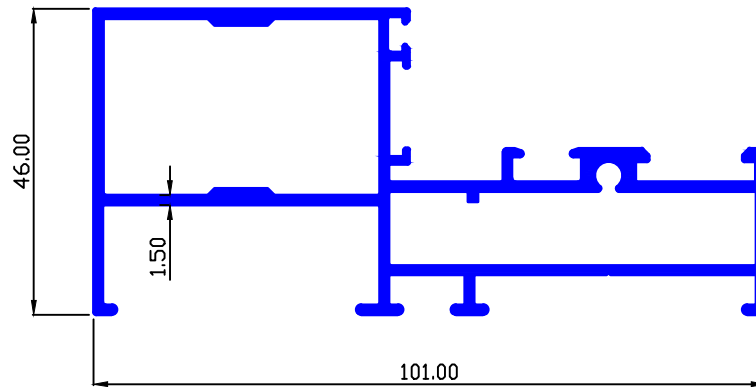

MAAN SEC.-90623

1.208 Kg/Mtr.

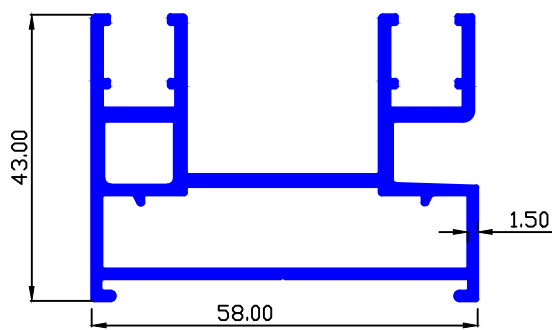

MAAN SEC.-90666

0.909 Kg/Mtr.

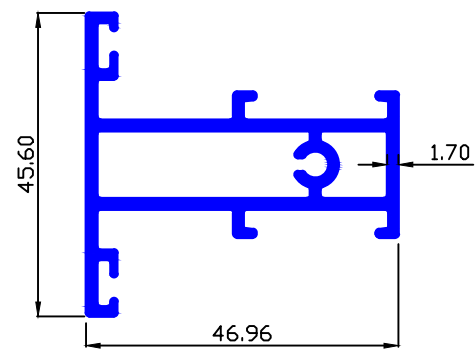



SLIDING

MAAN SEC.-90667

1.408 Kg/Mtr.

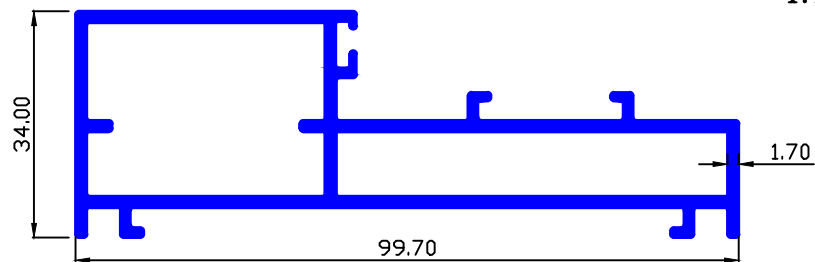

MAAN SEC.-90668

1.332 Kg/Mtr.

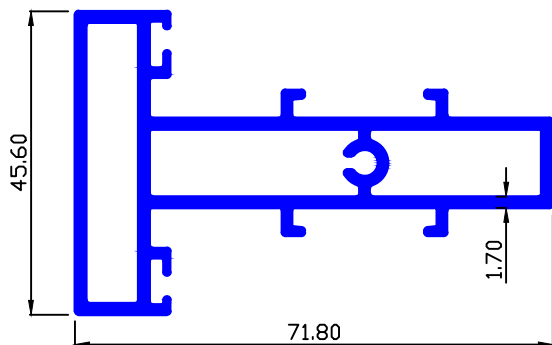

MAAN SEC.-90669

1.026 Kg/Mtr.

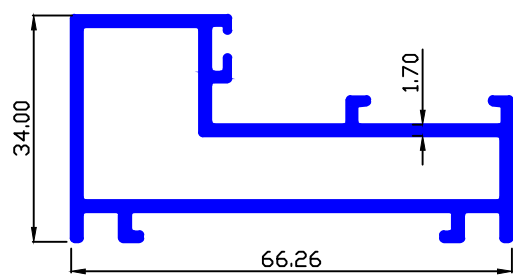

MAAN SEC.-90670

0.244 Kg/Mtr.

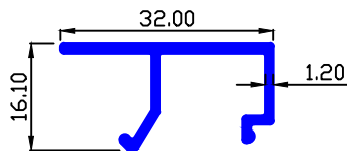

MAAN SEC.-90675

0.762 Kg/Mtr.

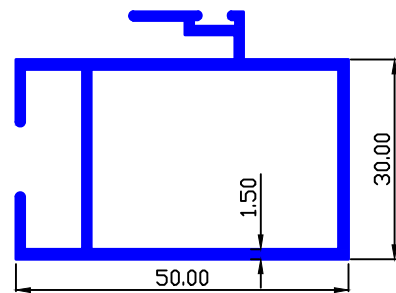

MAAN SEC.-90674

0.688 Kg/Mtr.

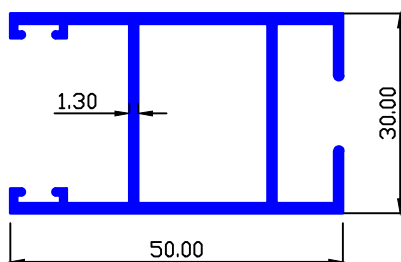

MAAN SEC.-90676

0.754 Kg/Mtr.

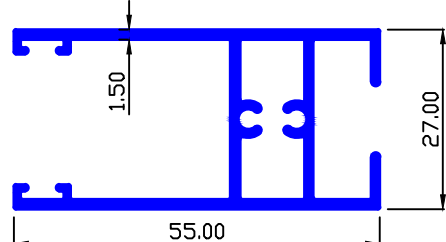



SLIDING

MAAN SEC.-90671

0.862 Kg/Mtr.

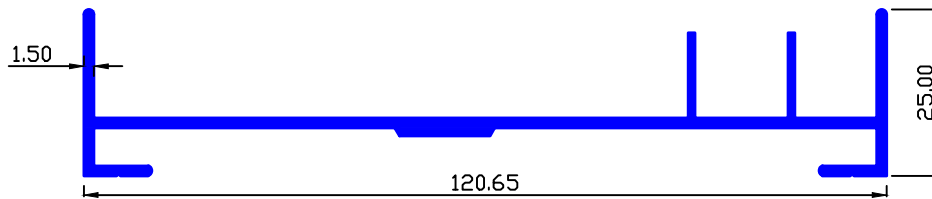

MAAN SEC.-90672

1.270 Kg/Mtr.

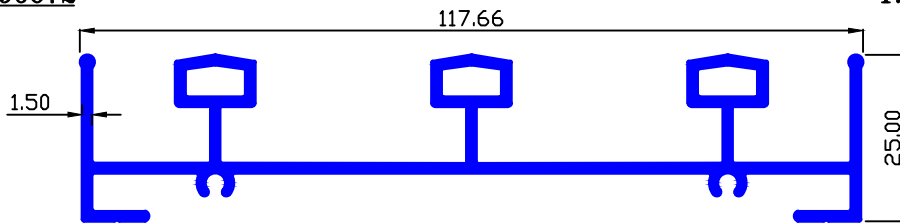

MAAN SEC.-90673

1.805 Kg/Mtr.

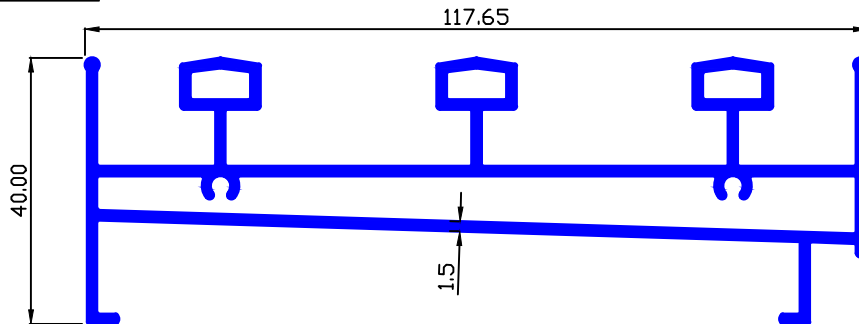

MAAN SEC.-90677

0.587 Kg/Mtr.

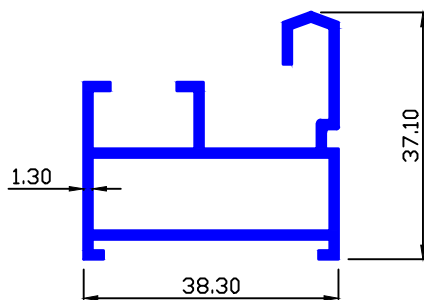

MAAN SEC.-90678

0.574 Kg/Mtr.

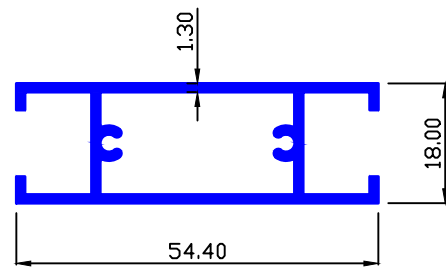



SLIDING

MAAN SEC.-90691

0.706 Kg/Mtr.

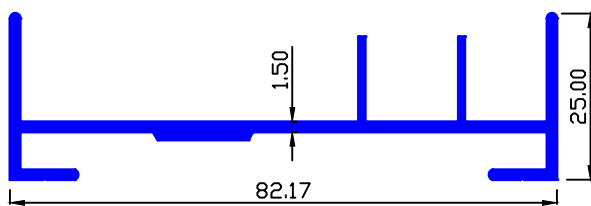

MAAN SEC.-90693

0.952 Kg/Mtr.

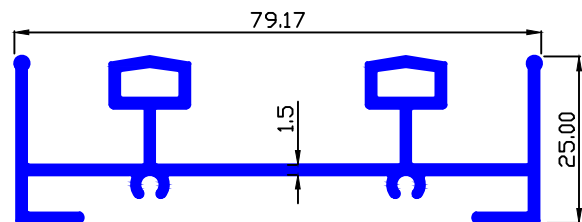

MAAN SEC.-90692

1.332 Kg/Mtr.

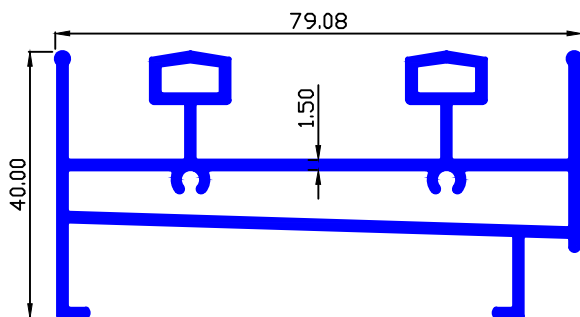

MAAN SEC.-90700

1.029 Kg/Mtr.

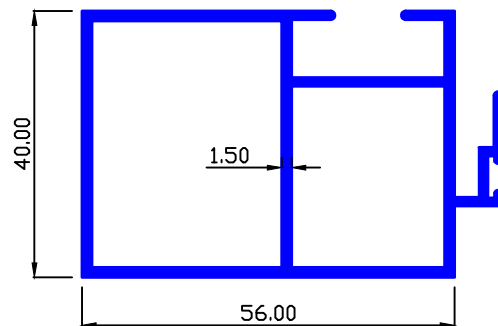

MAAN SEC.-90142

1.290 Kg/Mtr.

