

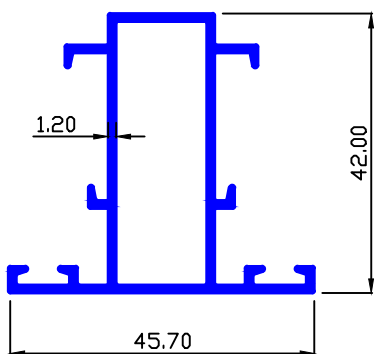

CASEMENT WINDOW

MAAN SEC.-6740

0.618 Kg/Mtr.



MAAN SEC.-6753

0.227 Kg/Mtr.

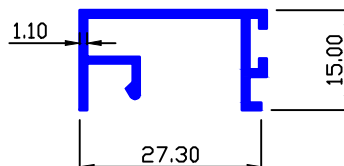

MAAN SEC.-6754

0.452 Kg/Mtr.

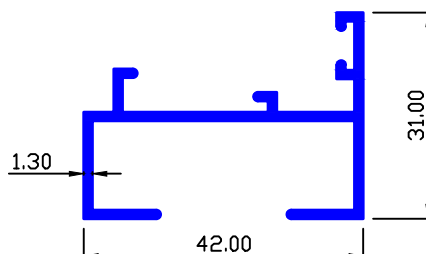

MAAN SEC.-6755

0.650 Kg/Mtr.

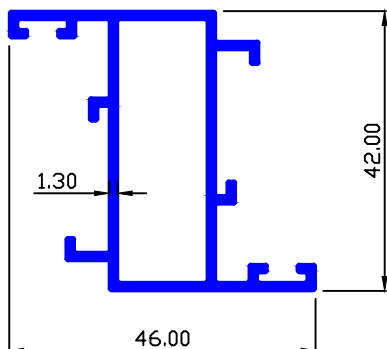

MAAN SEC.-7605

1.114 Kg/Mtr.

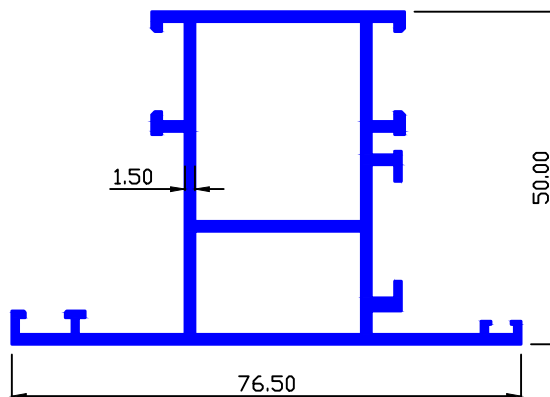

MAAN SEC.-7606

0.878 Kg/Mtr.

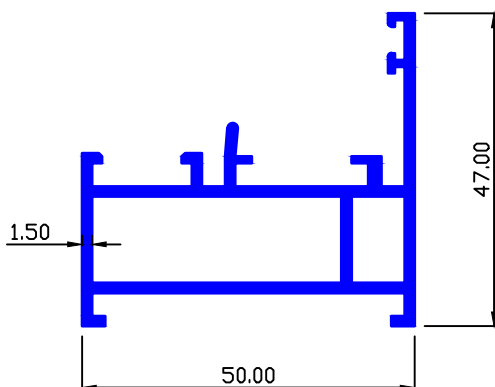

MAAN SEC.-7607

0.363 Kg/Mtr.

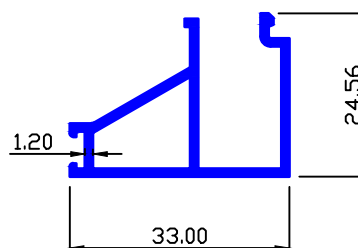



CASEMENT WINDOW

MAAN SEC.-7608

0.514 Kg/Mtr.

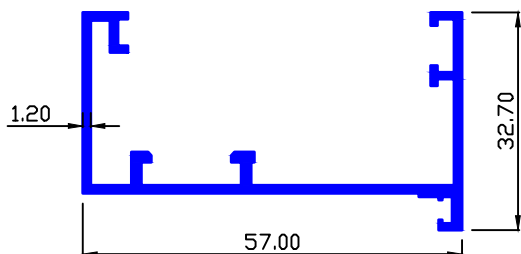

MAAN SEC.-7881

0.682 Kg/Mtr.

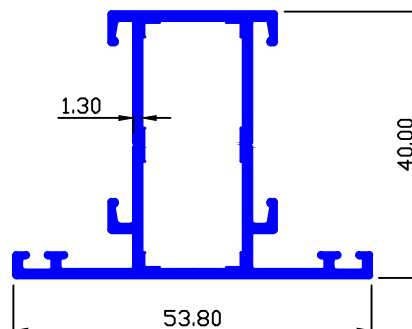

MAAN SEC.-7879

0.791 Kg/Mtr.

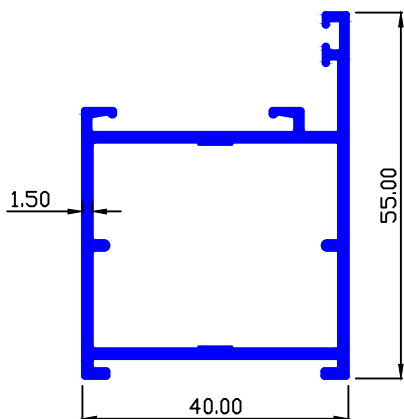

MAAN SEC.-7882

0.887 Kg/Mtr.

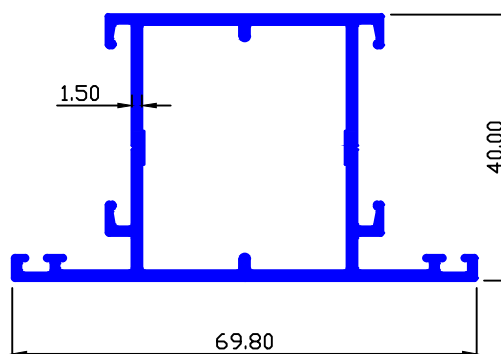

MAAN SEC.-7883

0.366 Kg/Mtr.

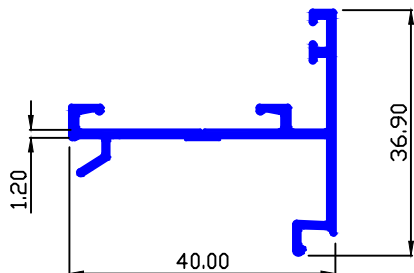

MAAN SEC.-7904

0.934 Kg/Mtr.

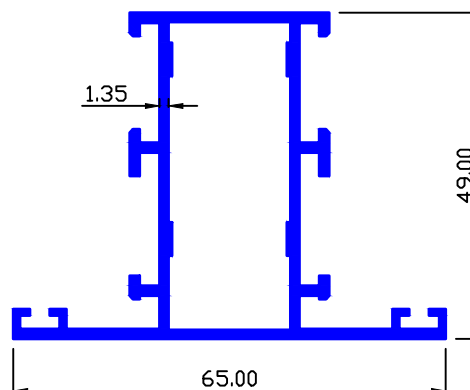



CASEMENT WINDOW

MAAN SEC.-7907

0.804 Kg/Mtr.

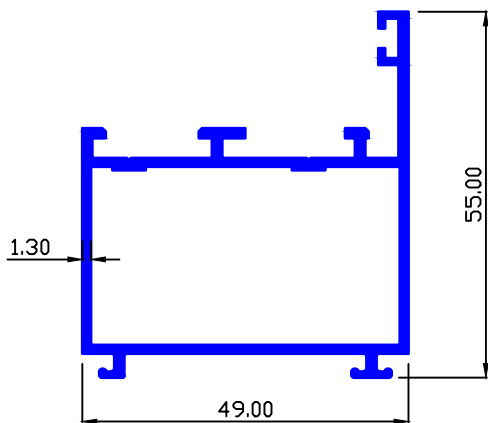

MAAN SEC.-7919

0.300 Kg/Mtr.

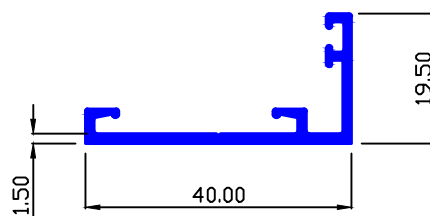

MAAN SEC.-7951

1.034 Kg/Mtr.

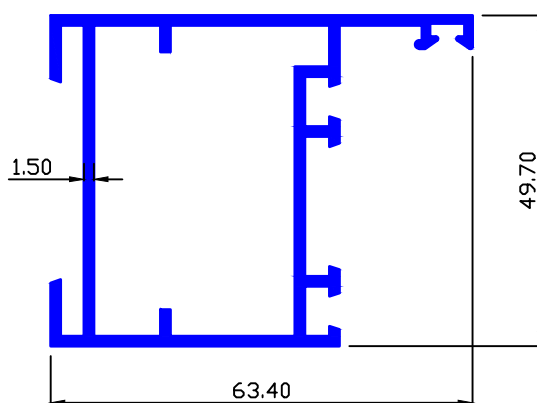

MAAN SEC.-7952

0.936 Kg/Mtr.

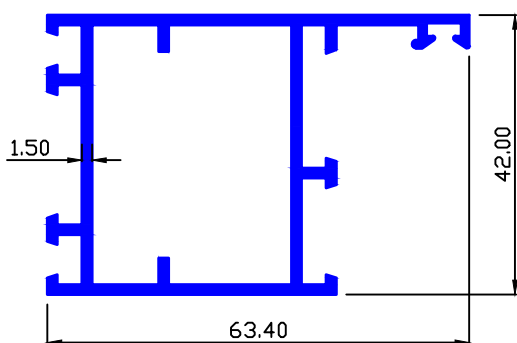

MAAN SEC.-7956

1.497 Kg/Mtr.

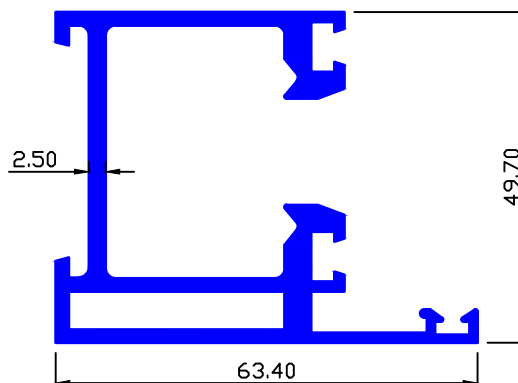

MAAN SEC.-7953

0.203 Kg/Mtr.

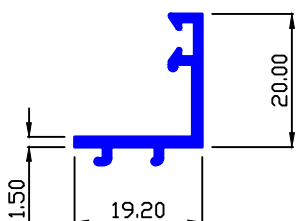

MAAN SEC.-7918

0.456 Kg/Mtr.

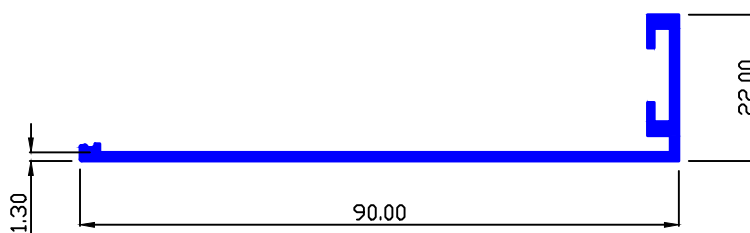



CASEMENT WINDOW

MAAN SEC.-7957

1.123 Kg/Mtr.

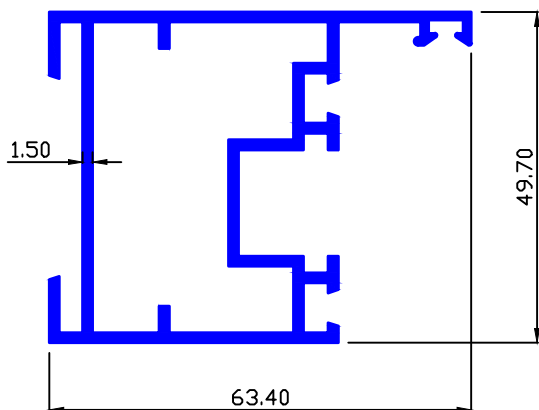

MAAN SEC.-8611

0.916 Kg/Mtr.

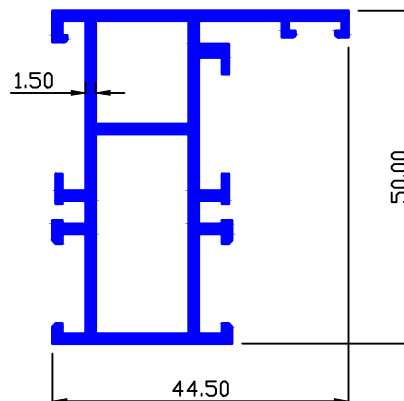

MAAN SEC.-8010

0.855 Kg/Mtr.

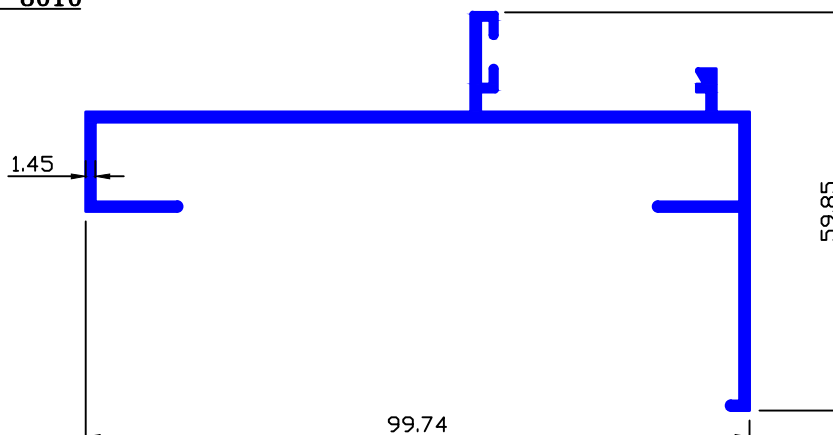

MAAN SEC.-8627

0.169 Kg/Mtr.

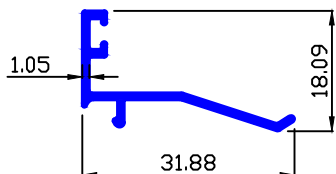

MAAN SEC.-8705

0.861 Kg/Mtr.

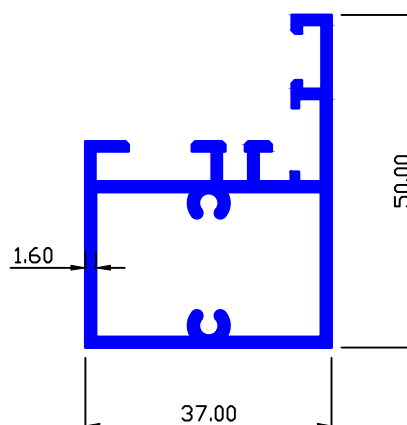

MAAN SEC.-8023

0.225 Kg/Mtr.

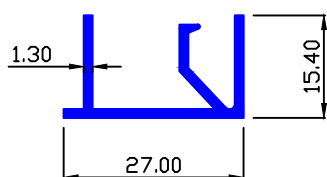



CASEMENT WINDOW

MAAN SEC.-8708

1.298 Kg/Mtr.

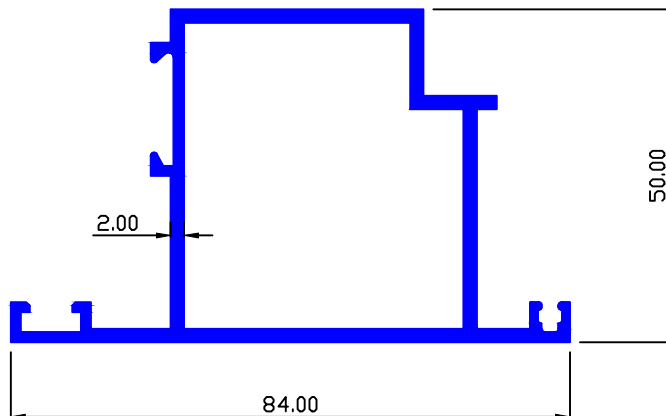

MAAN SEC.-8709

0.840 Kg/Mtr.

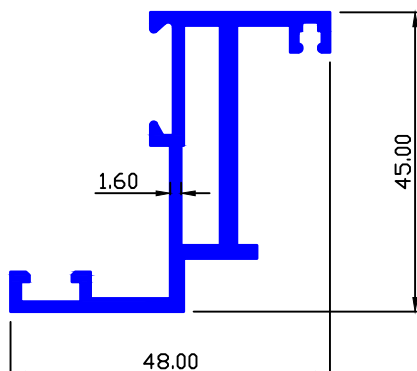

MAAN SEC.-8751

0.586 Kg/Mtr.

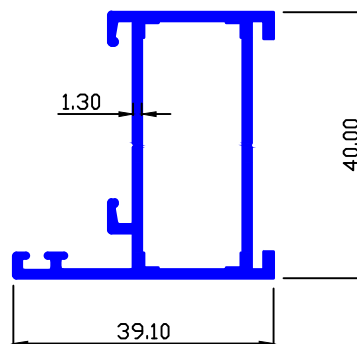

MAAN SEC.-8802

0.568 Kg/Mtr.

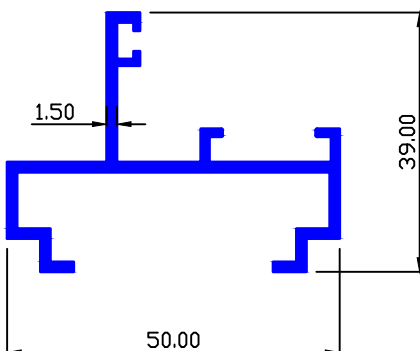

MAAN SEC.-8803

0.646 Kg/Mtr.

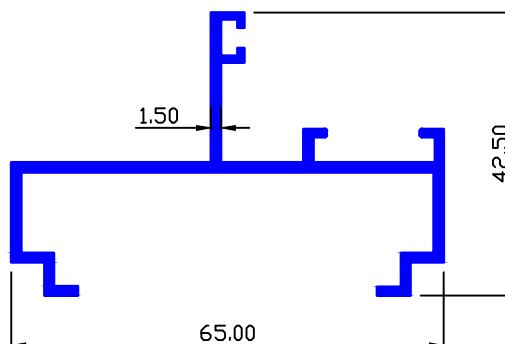



CASEMENT WINDOW

MAAN SEC.-8804

0.738 Kg/Mtr.

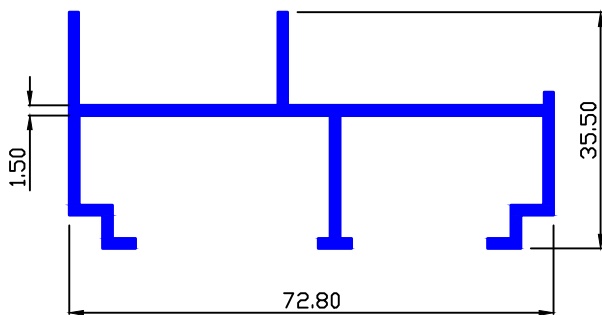

MAAN SEC.-8805

0.801 Kg/Mtr.

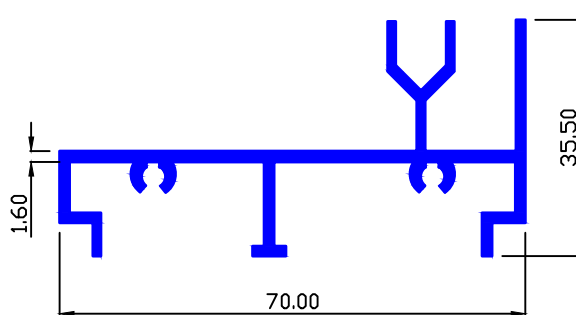

MAAN SEC.-8806

0.463 Kg/Mtr.

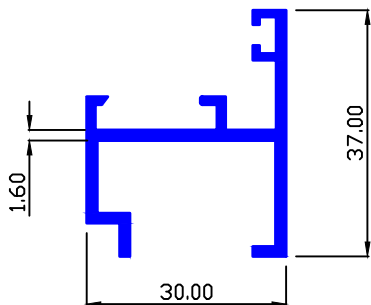

MAAN SEC.-8815

0.731 Kg/Mtr.

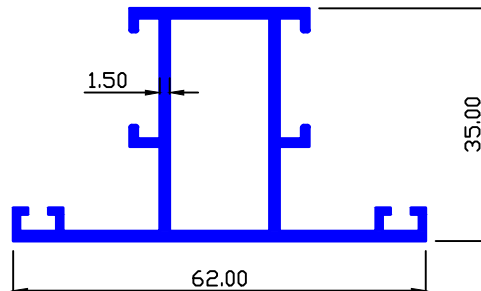

MAAN SEC.-8818

0.637 Kg/Mtr.

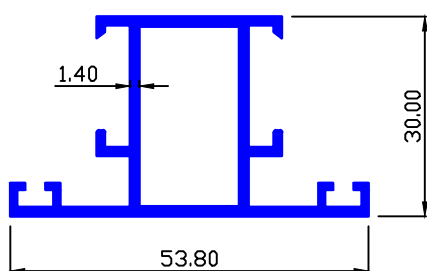

MAAN SEC.-8840

0.731 Kg/Mtr.

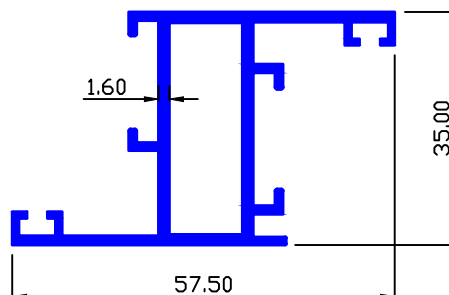

MAAN SEC.-8841

0.609 Kg/Mtr.

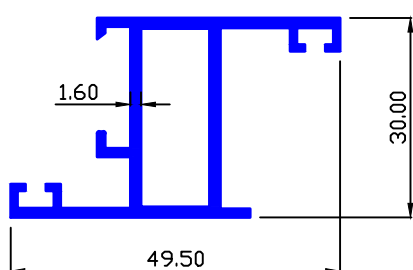

MAAN SEC.-8887

0.826 Kg/Mtr.

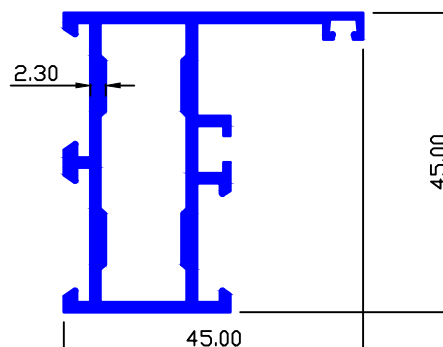



CASEMENT WINDOW

MAAN SEC.-8888

1.357 Kg/Mtr.

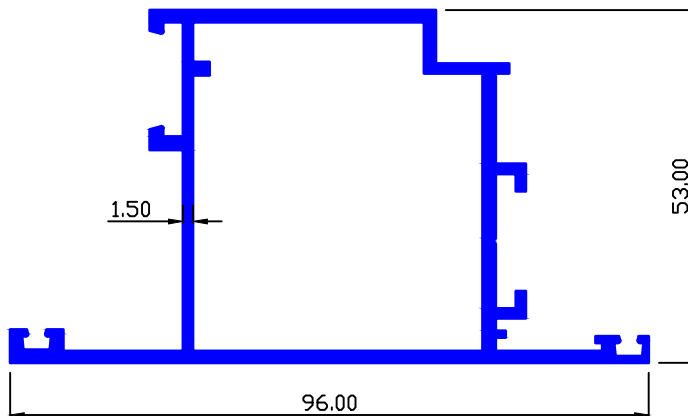

MAAN SEC.-8930

1.044 Kg/Mtr.

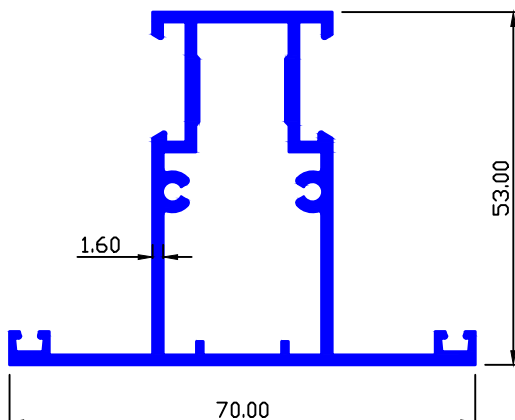

MAAN SEC.-8931

0.837 Kg/Mtr.

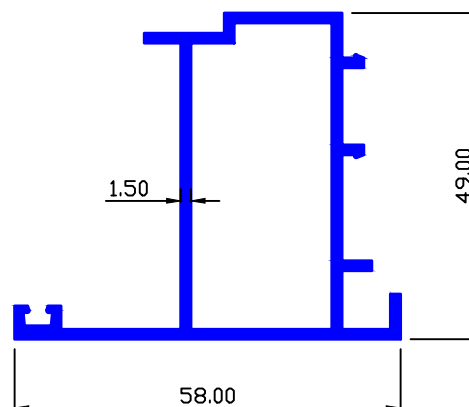

MAAN SEC.-8979

1.941 Kg/Mtr.

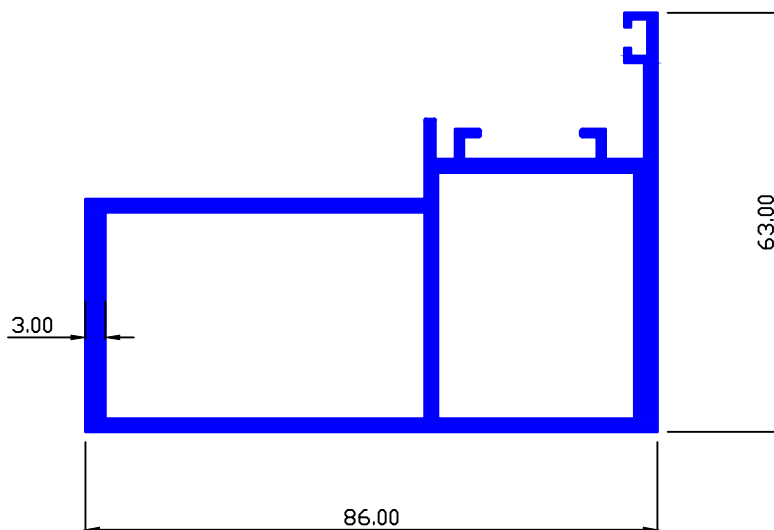



CASEMENT WINDOW

MAAN SEC.-8980

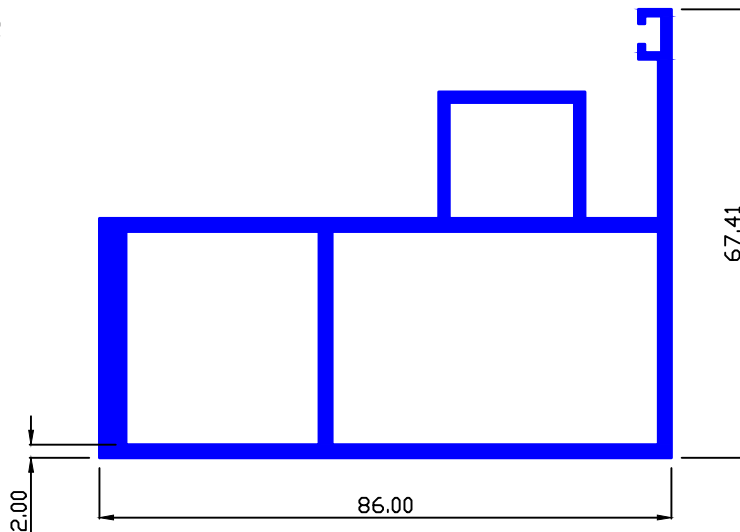

2.055 Kg/Mtr.

MAAN SEC.-89077

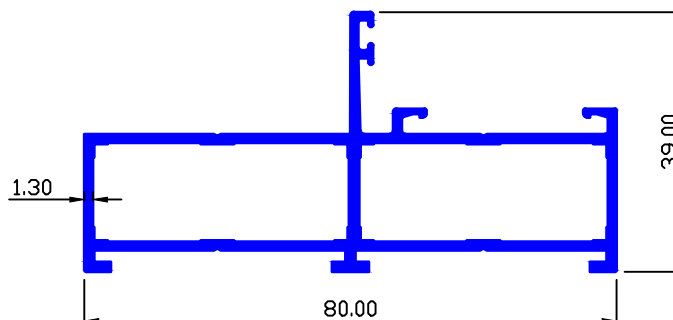

0.961 Kg/Mtr.

MAAN SEC.-89123

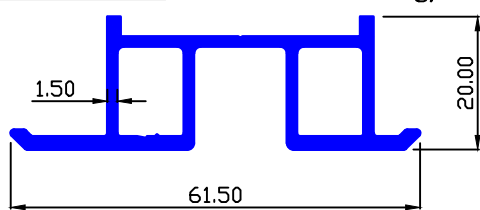

0.672 Kg/Mtr.

MAAN SEC.-89124

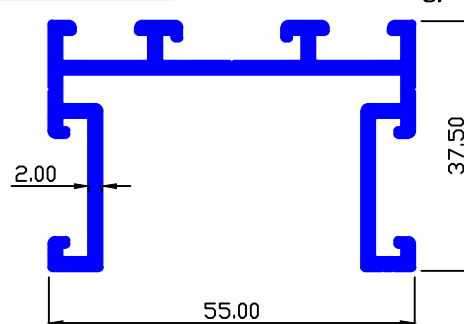

1.029 Kg/Mtr.

MAAN SEC.-89141

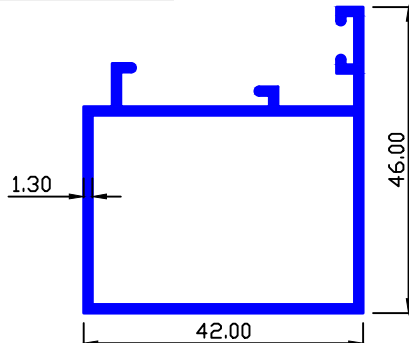

0.627 Kg/Mtr.

MAAN SEC.-89142

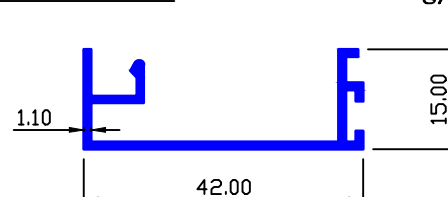

0.274 Kg/Mtr.



CASEMENT WINDOW

MAAN SEC.-89144

0.473 Kg/Mtr.

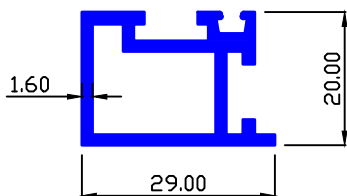

MAAN SEC.-8025

0.520 Kg/Mtr.

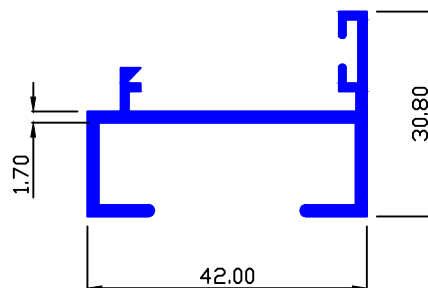

MAAN SEC.-89201

0.766 Kg/Mtr.

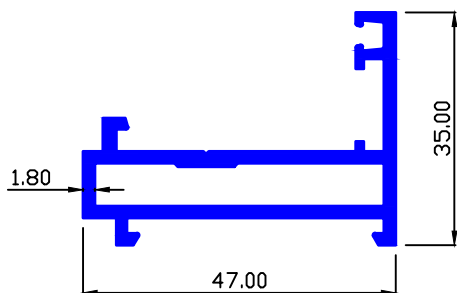

MAAN SEC.-89242

1.275 Kg/Mtr.

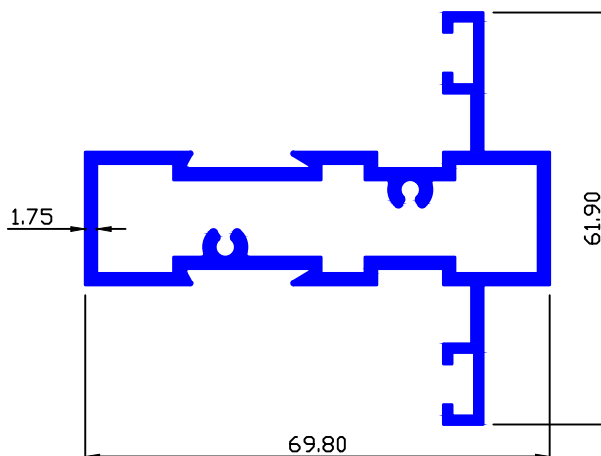

MAAN SEC.-89243

0.750 Kg/Mtr.

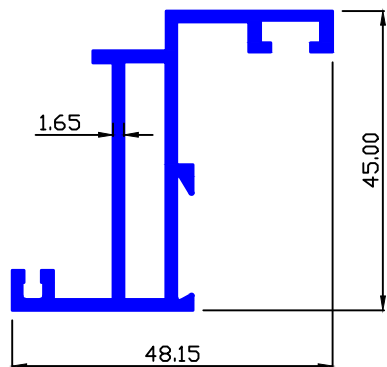

MAAN SEC.-89260

0.850 Kg/Mtr.

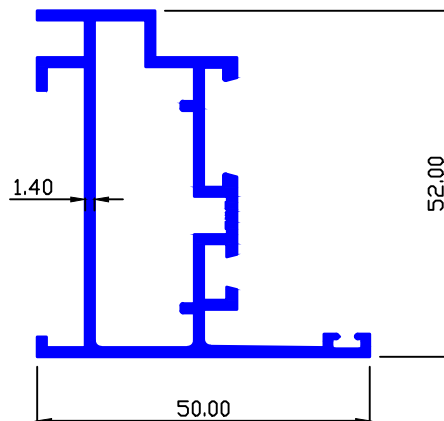

MAAN SEC.-89249

0.950 Kg/Mtr.

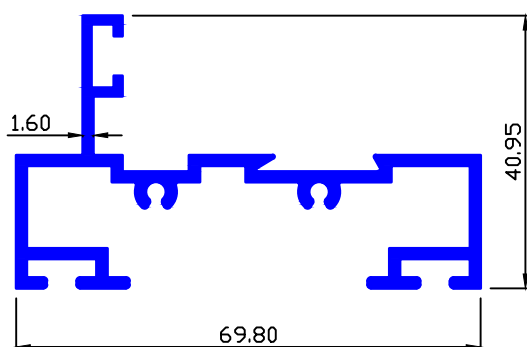



CASEMENT WINDOW

MAAN SEC.-89272

0.820 Kg/Mtr.

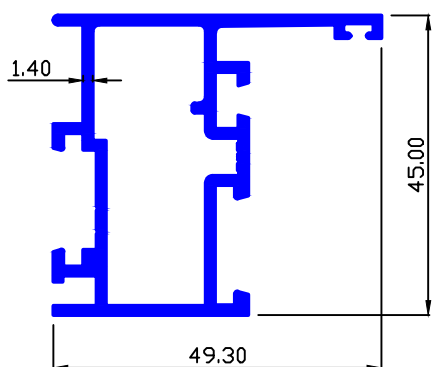

MAAN SEC.-89284

0.648 Kg/Mtr.

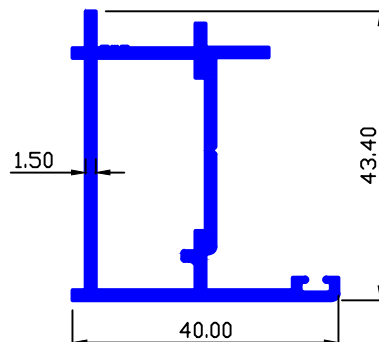

MAAN SEC.-89273

0.906 Kg/Mtr.

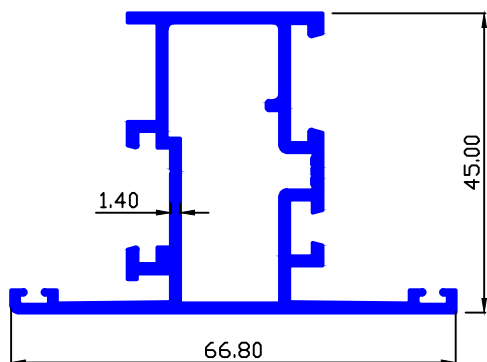

MAAN SEC.-89283

1.120 Kg/Mtr.

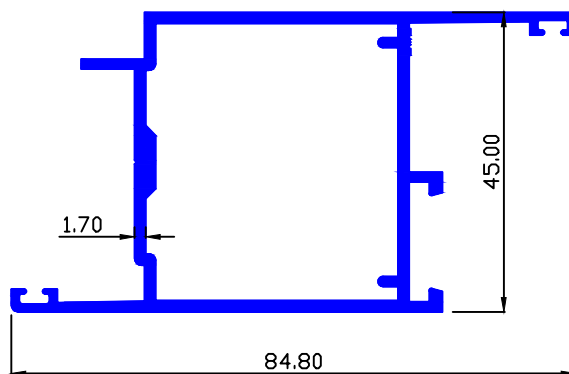

MAAN SEC.-89276

1.275 Kg/Mtr.

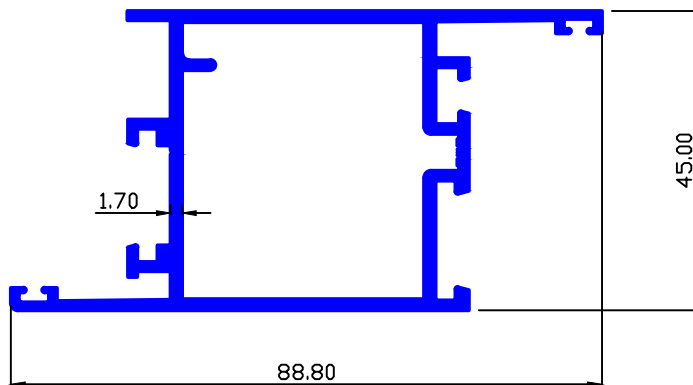



CASEMENT WINDOW

MAAN SEC.-89285

0.507 Kg/Mtr.

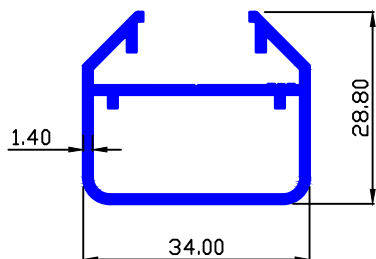

MAAN SEC.-89287

0.194 Kg/Mtr.

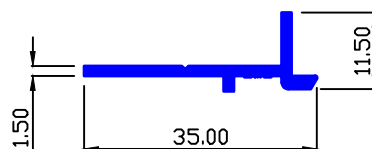

MAAN SEC.-89286

0.613 Kg/Mtr.

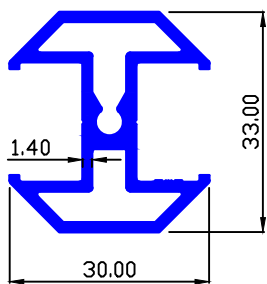

MAAN SEC.-89288

0.379 Kg/Mtr.

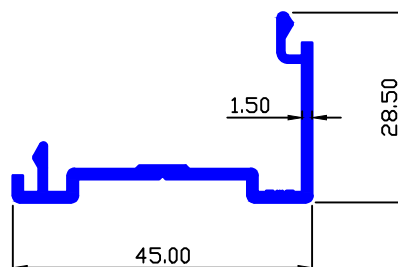

MAAN SEC.-89374

0.662 Kg/Mtr.

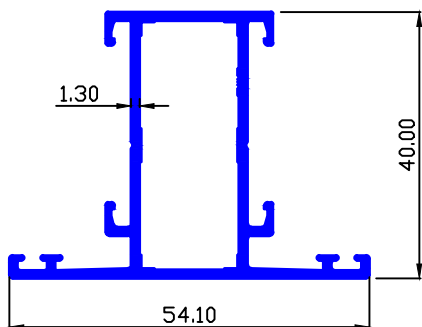

MAAN SEC.-89289

0.479 Kg/Mtr.

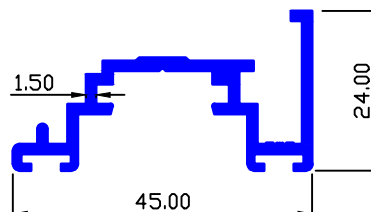

MAAN SEC.-89375

0.577 Kg/Mtr.

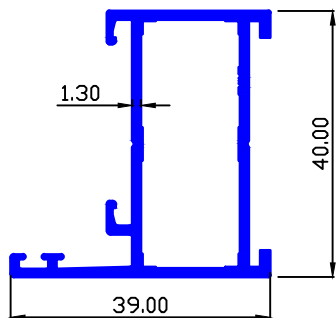

MAAN SEC.-89466

0.769 Kg/Mtr.

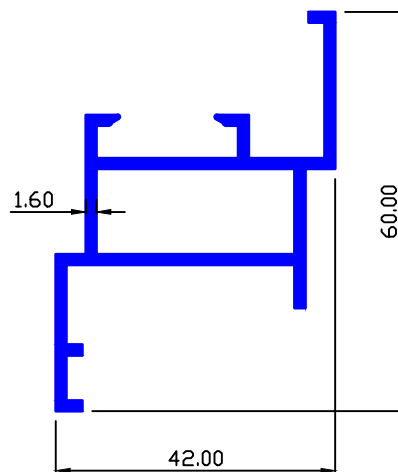



CASEMENT WINDOW

MAAN SEC.-89522

0.852 Kg/Mtr.

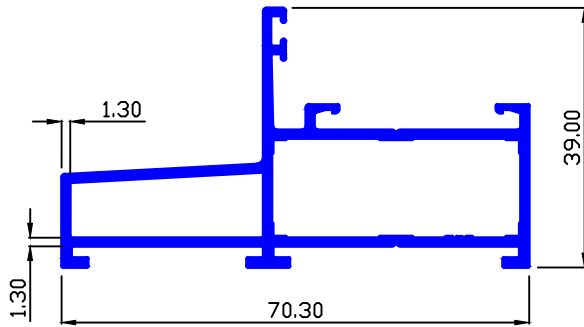

MAAN SEC.-89537

0.476 Kg/Mtr.

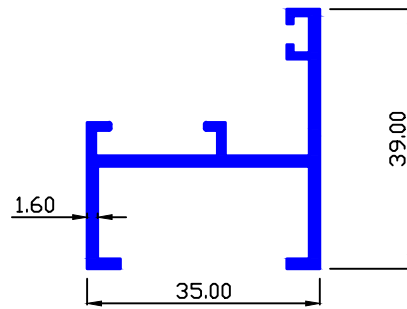

MAAN SEC.-89538

0.821 Kg/Mtr.

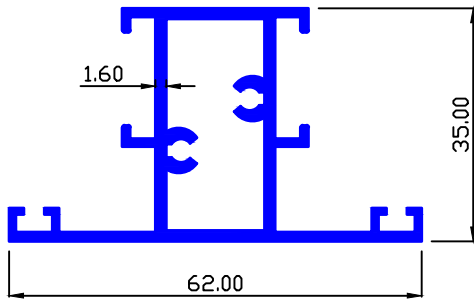

MAAN SEC.-89540

0.745 Kg/Mtr.

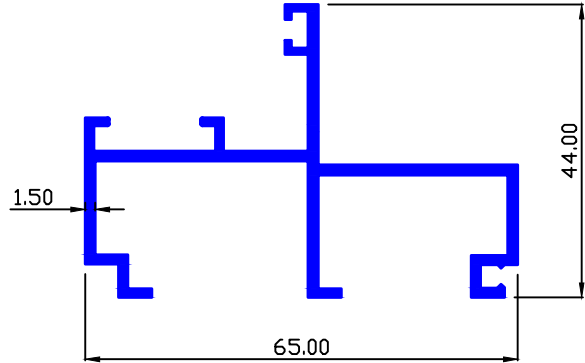

MAAN SEC.-8513

0.670 Kg/Mtr.

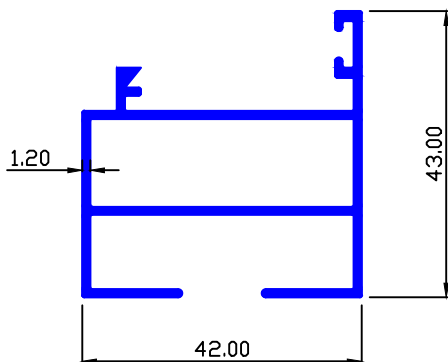

MAAN SEC.-8026

0.715 Kg/Mtr.

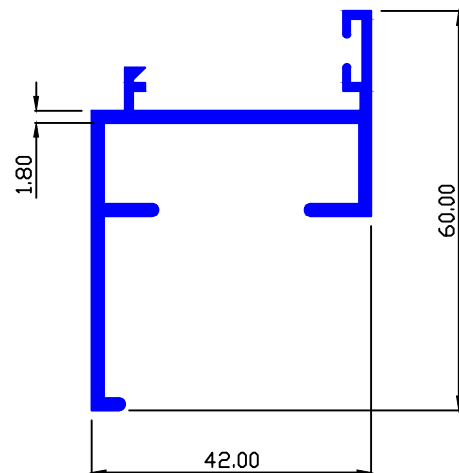

MAAN SEC.-89867

0.173 Kg/Mtr.

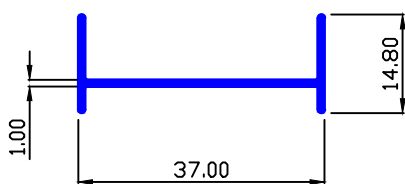



CASEMENT WINDOW

MAAN SEC.-89868

0.292 Kg/Mtr.

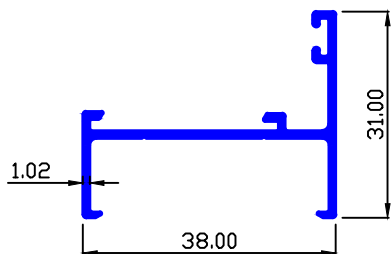

MAAN SEC.-89890

0.686 Kg/Mtr.

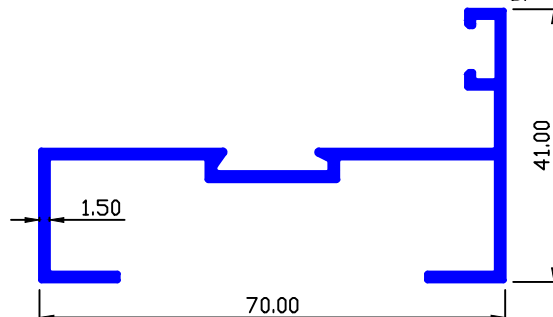

MAAN SEC.-89870

0.234 Kg/Mtr.

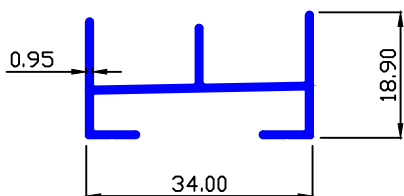

MAAN SEC.-89888

1.040 Kg/Mtr.

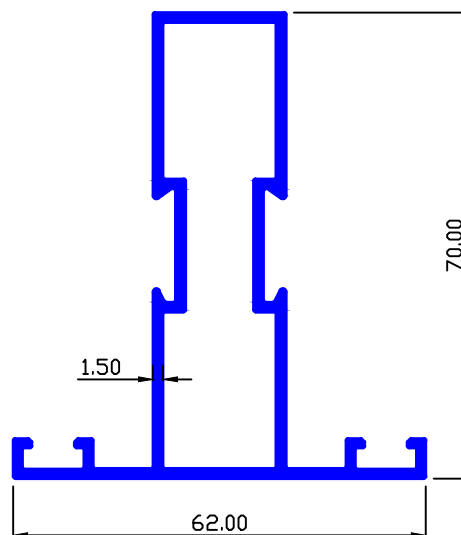

MAAN SEC.-89873

0.471 Kg/Mtr.

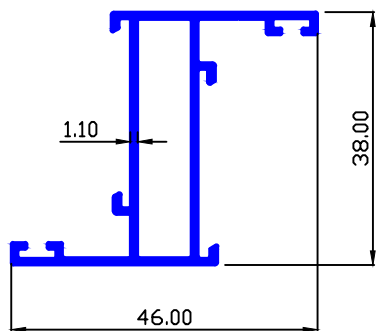

MAAN SEC.-89889

0.657 Kg/Mtr.

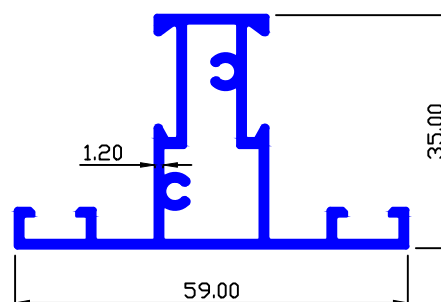

MAAN SEC.-89874

0.535 Kg/Mtr.

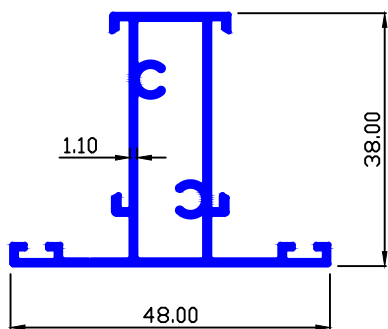

MAAN SEC.-89891

0.112 Kg/Mtr.

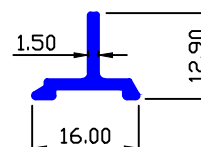



CASEMENT WINDOW

MAAN SEC.-8206

0.635 Kg/Mtr.

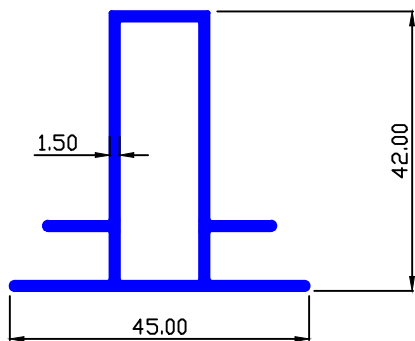

MAAN SEC.-89894

0.385 Kg/Mtr.

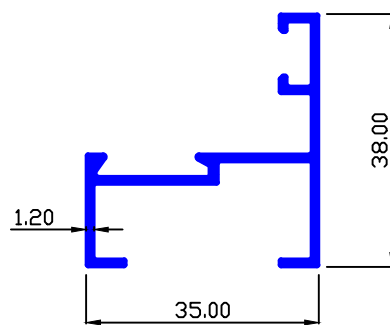

MAAN SEC.-89903

0.674 Kg/Mtr.

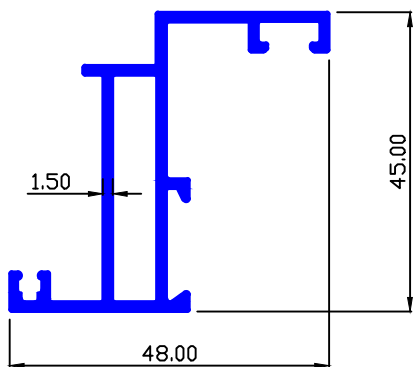

MAAN SEC.-90425

1.197 Kg/Mtr.

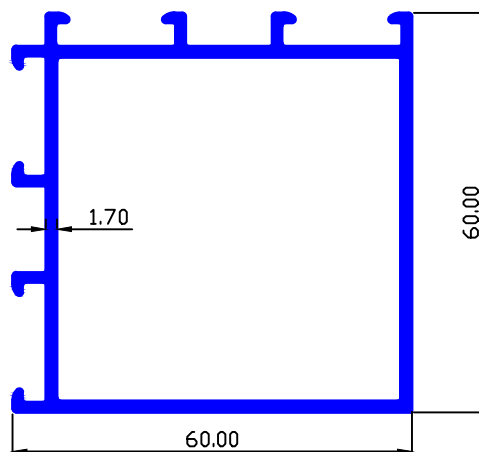



CASEMENT WINDOW

MAAN SEC.-8003

0.980 Kg/Mtr.

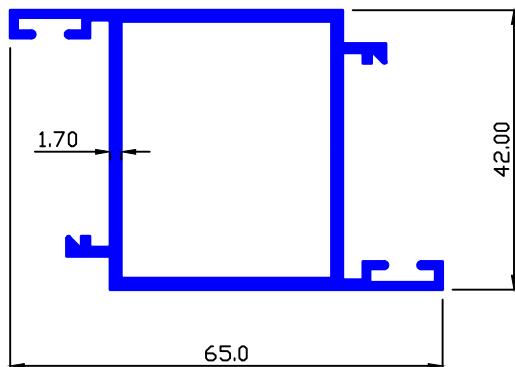

MAAN SEC.-8012

1.055 Kg/Mtr.

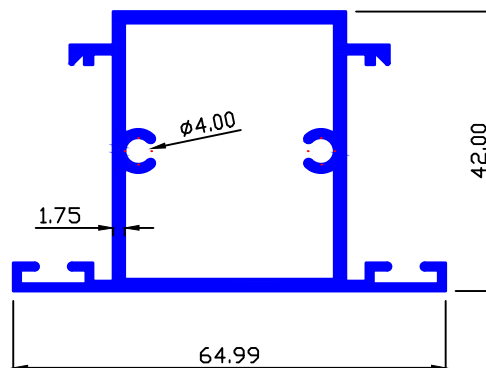

MAAN SEC.-8004

1.055 Kg/Mtr.

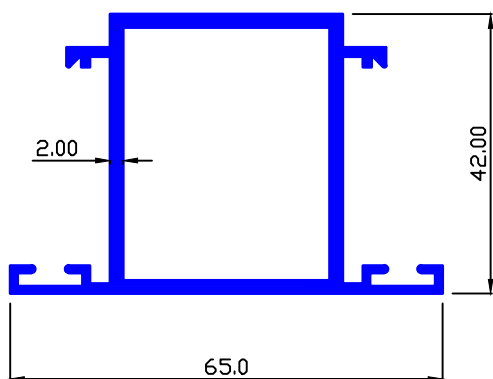

MAAN SEC.-8021

0.800 Kg/Mtr.

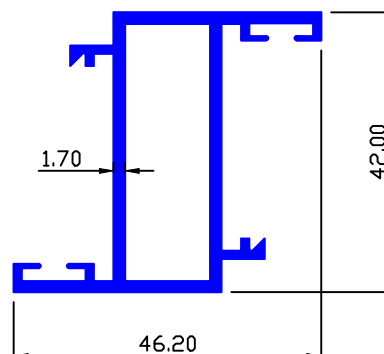

MAAN SEC.-8011

0.690 Kg/Mtr.

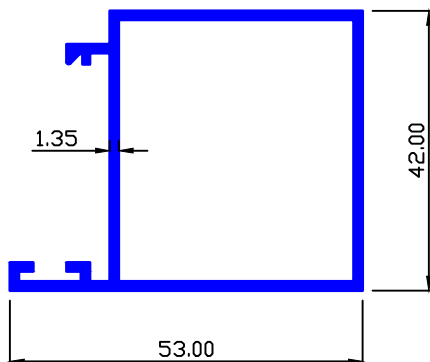

MAAN SEC.-8022

0.800 Kg/Mtr.

