

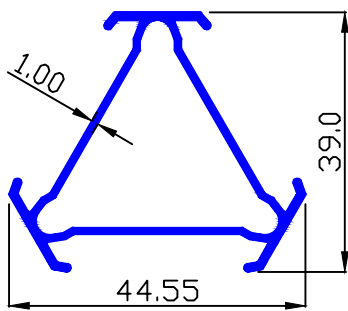

MISCELLANEOUS

MAAN SEC.-89913

0.452 Kg/Mtr.



MAAN SEC.- 90791

0.582 Kg/Mtr.

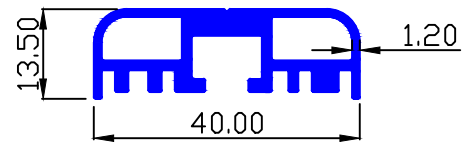

MAAN SEC.-90012

1.388 Kg/Mtr.

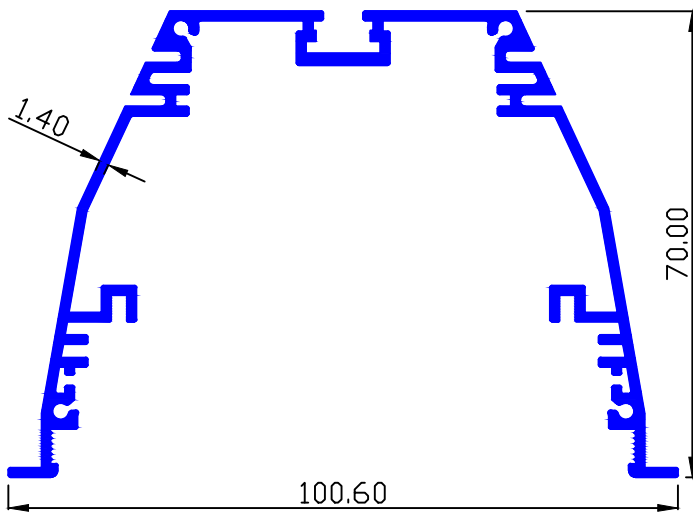

MAAN SEC.-90018

0.212 Kg/Mtr.

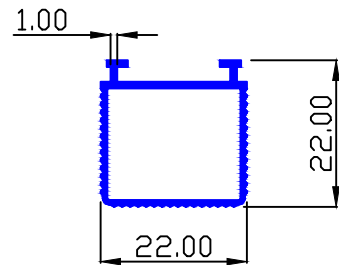

MAAN SEC.-90050

2.425 Kg/Mtr.

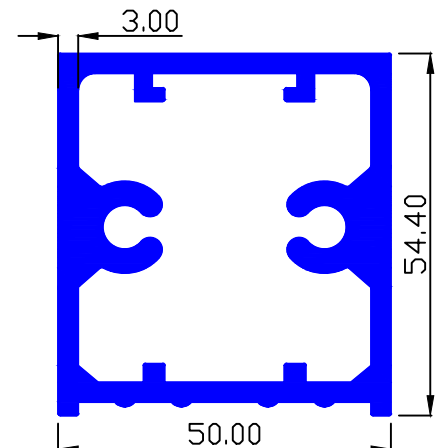

MAAN SEC.-90084

0.592 Kg/Mtr.

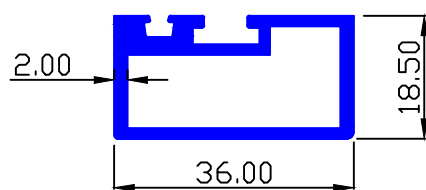



MISCELLANEOUS

MAAN SEC.- 90167

0.561 Kg/Mtr.

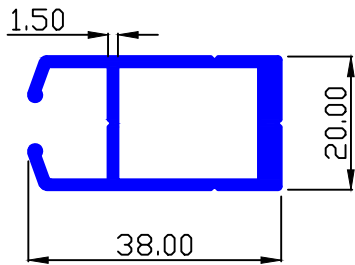

MAAN SEC.- 90245

1.305 Kg/Mtr.

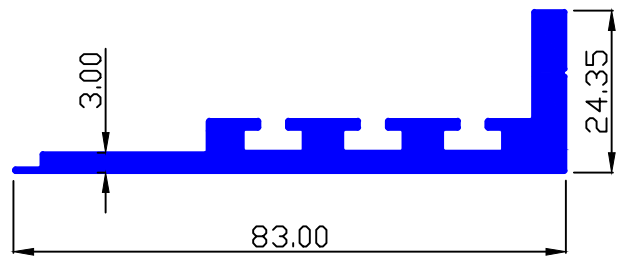

MAAN SEC.-90186

3.098 Kg/Mtr.

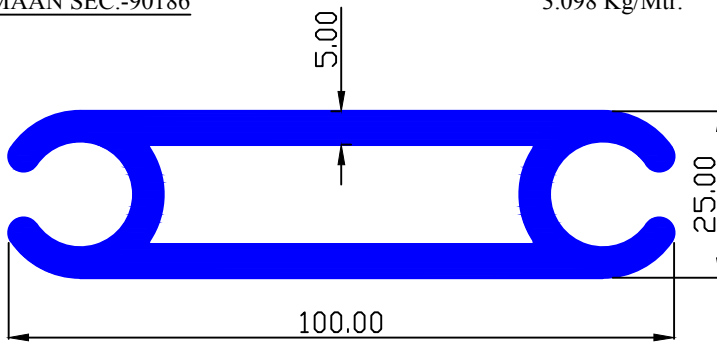

MAAN SEC.-90246

1.009 Kg/Mtr.

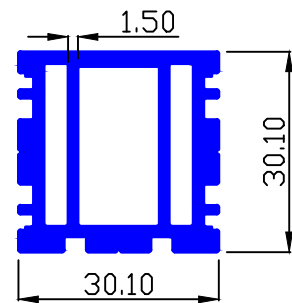

MAAN SEC.-90249

1.625 Kg/Mtr.

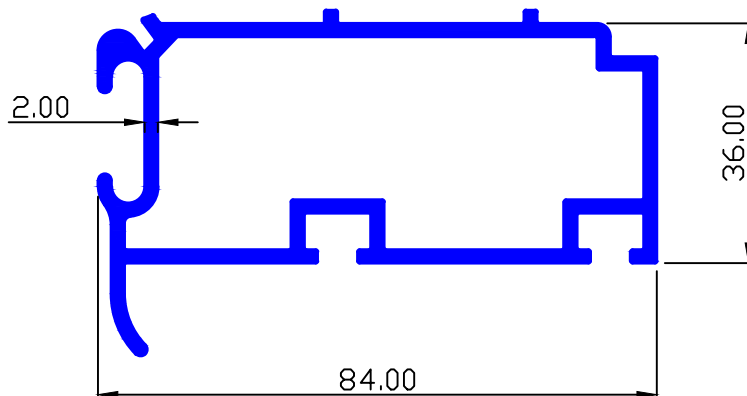



MISCELLANEOUS

MAAN SEC.- 90250

1.825 Kg/Mtr.

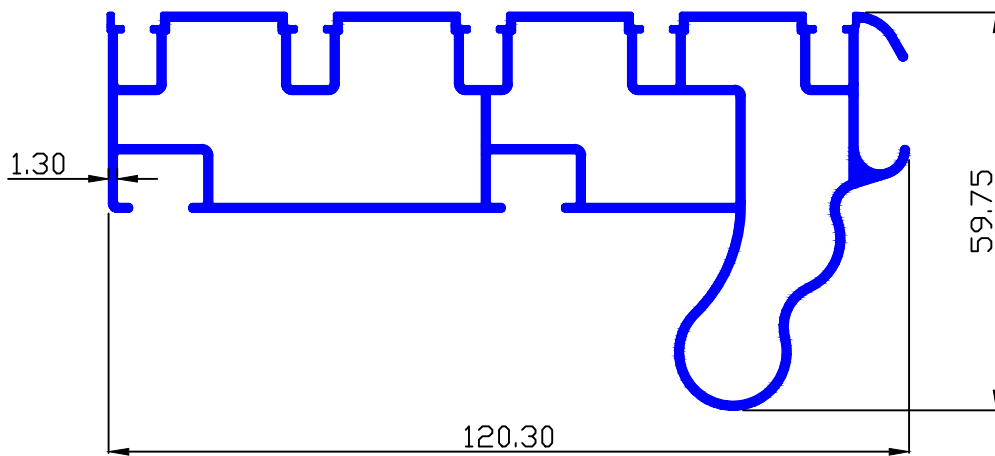

MAAN SEC.-90251

0.622 Kg/Mtr.

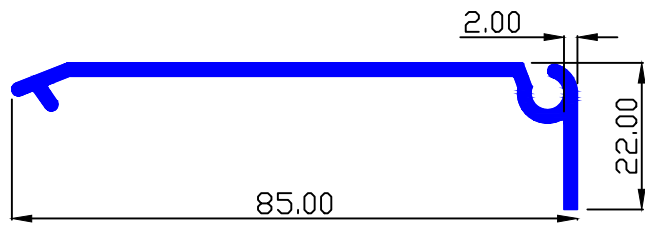

MAAN SEC.-90319

0.302 Kg/Mtr.

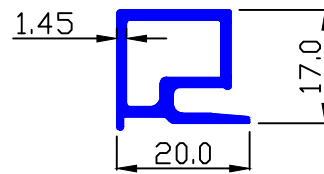

MAAN SEC.-90382

0.776 Kg/Mtr.

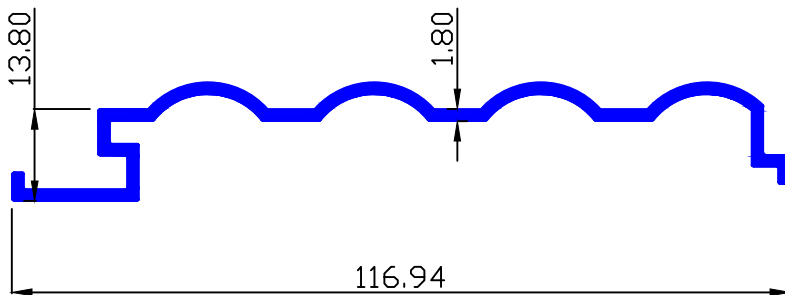

MAAN SEC.-90380

2.077 Kg/Mtr.

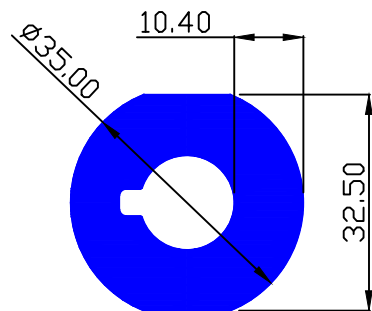



MISCELLANEOUS

MAAN SEC.- 90334

2.035 Kg/Mtr.

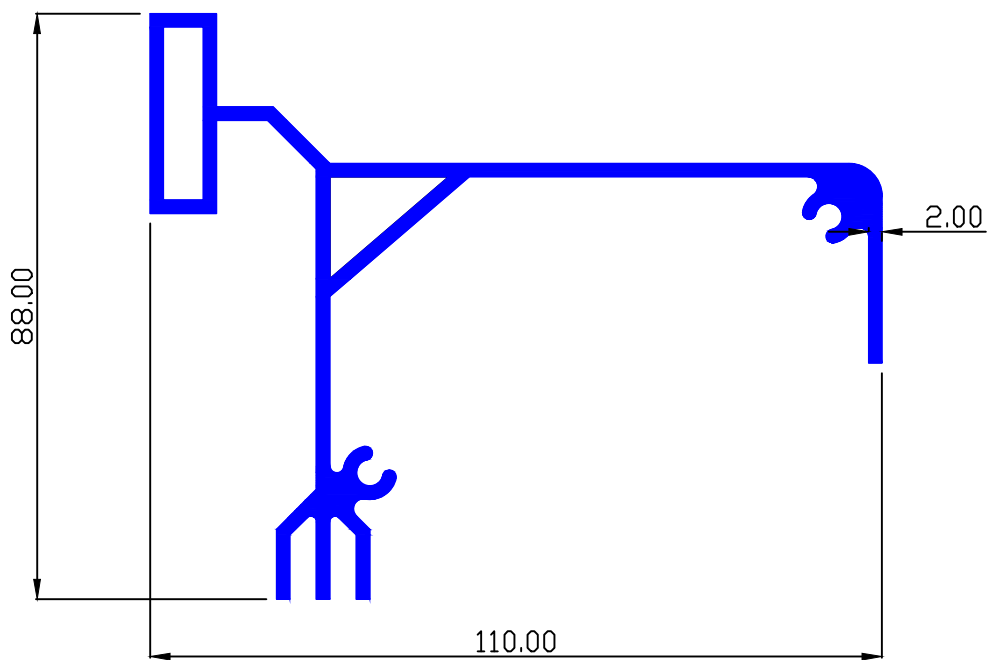

MAAN SEC.- 90364

0.511 Kg/Mtr.

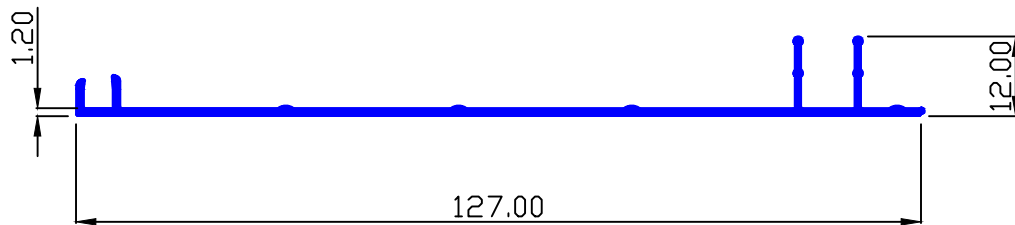



MISCELLANEOUS

MAAN SEC.- 90381

2.244 Kg/Mtr.

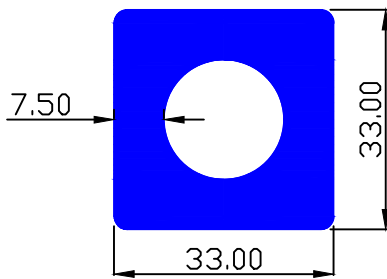

MAAN SEC.-90053

1.522 Kg/Mtr.

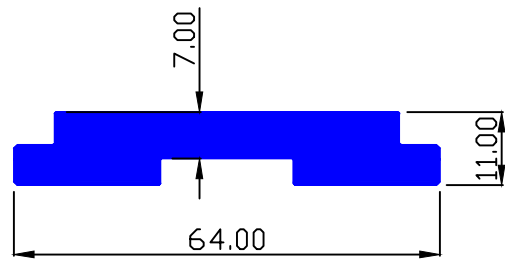

MAAN SEC.- 90399

1.036 Kg/Mtr.

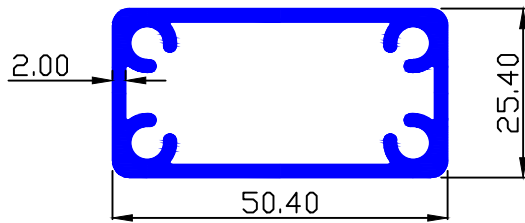

MAAN SEC.- 90402

0.753 Kg/Mtr.

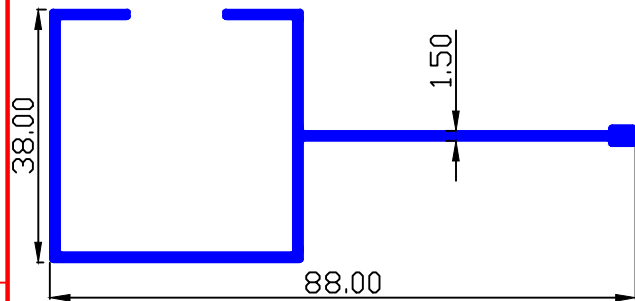

MAAN SEC.- 90540

1.923 Kg/Mtr.

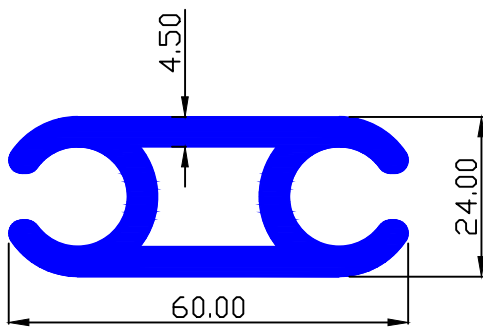

MAAN SEC.-90532

1.527 Kg/Mtr.

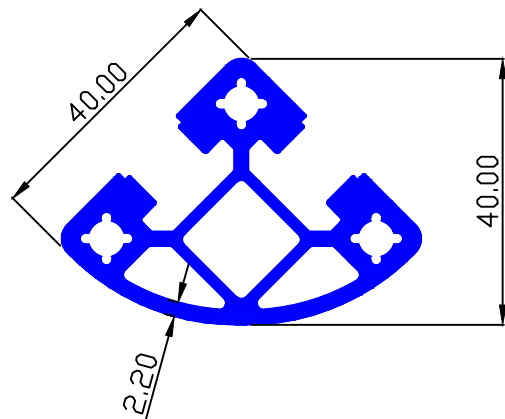



MISCELLANEOUS

MAAN SEC.- 90574

0.470 Kg/Mtr.

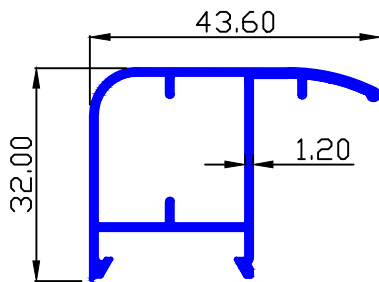

MAAN SEC.- 90591

0.458 Kg/Mtr.

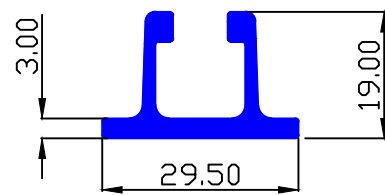

MAAN SEC.- 90592

0.559 Kg/Mtr.

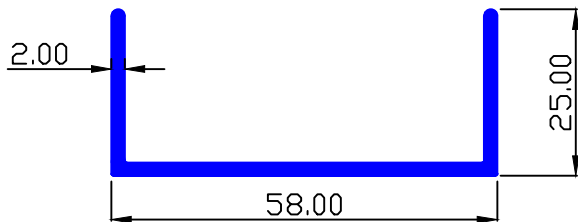

MAAN SEC.- 90642

0.857 Kg/Mtr.

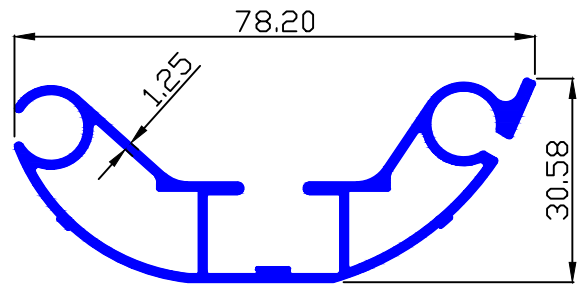

MAAN SEC.- 90602

1.275 Kg/Mtr.

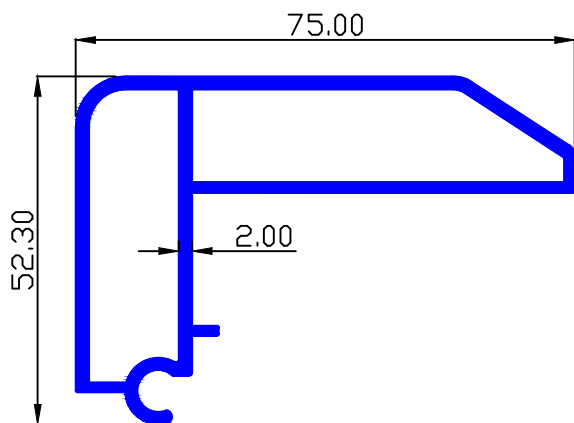

MAAN SEC.- 90750

1.868 Kg/Mtr.

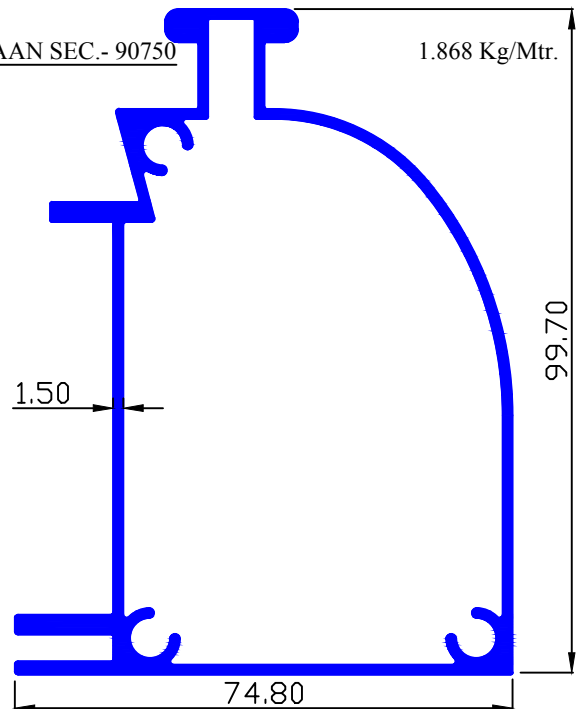



MISCELLANEOUS

MAAN SEC.- 90751

0.948 Kg/Mtr.

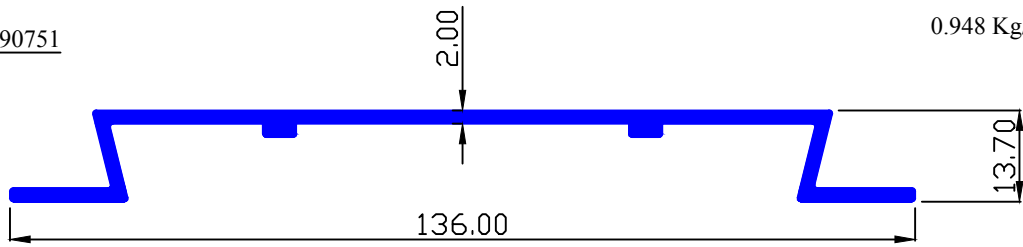

MAAN SEC.- 90763

0.265 Kg/Mtr.

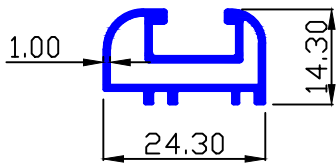

MAAN SEC.- 90767

0.112 Kg/Mtr.

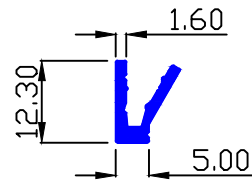

MAAN SEC.- 90768

0.165 Kg/Mtr.

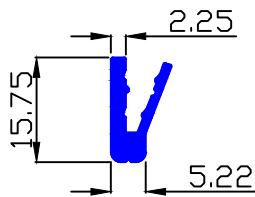

MAAN SEC.- 90772

0.347 Kg/Mtr.

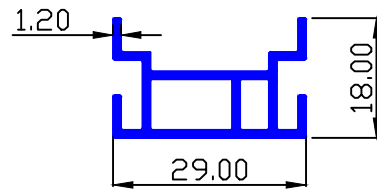

MAAN SEC.- 90773

0.732 Kg/Mtr.

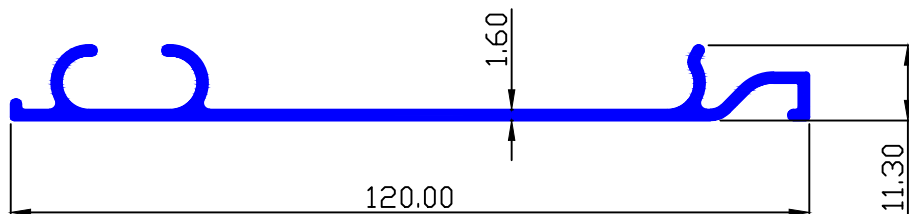



MISCELLANEOUS

MAAN SEC.- 90774

0.088 Kg/Mtr.

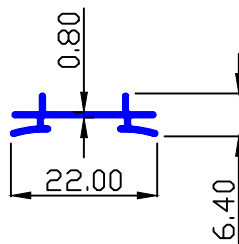

MAAN SEC.- 90780

0.101 Kg/Mtr.

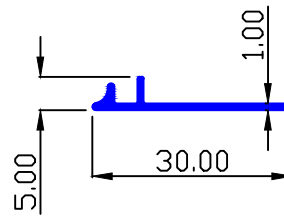

MAAN SEC.- 90781

0.179 Kg/Mtr.

