

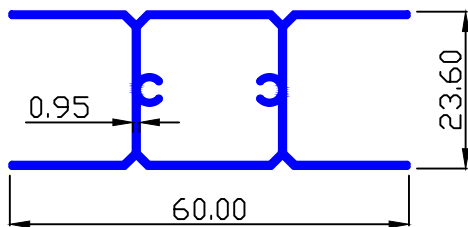

DOOR & WINDOW PARTITION

MAAN SEC.-6791

0.460 Kg/Mtr.



MAAN SEC.-6792

0.378 Kg/Mtr.

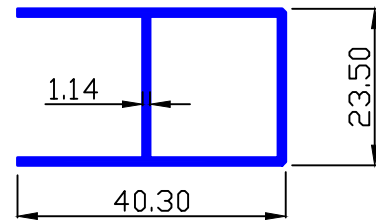

MAAN SEC.-6797

0.397 Kg/Mtr.

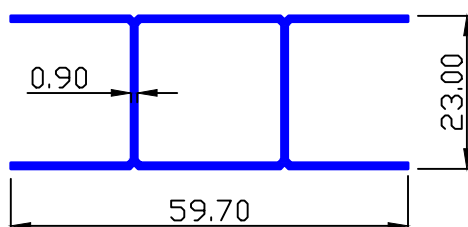

MAAN SEC.-6796

0.305 Kg/Mtr.

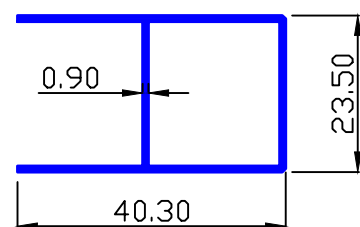

MAAN SEC.-6801/L

0.692 Kg/Mtr.

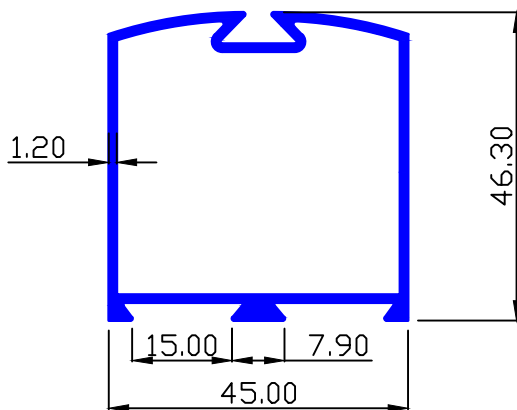

MAAN SEC.-6802

0.786 Kg/Mtr.

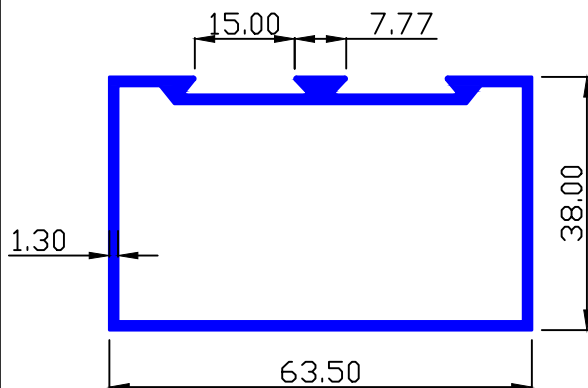

MAAN SEC.-6803

1.50 Kg/Mtr.

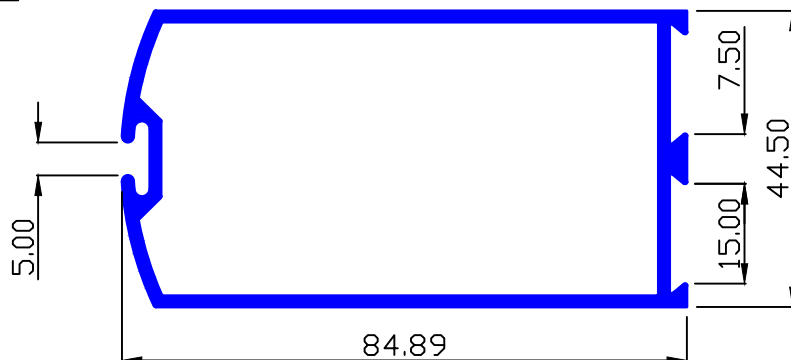



DOOR & WINDOW PARTITION

MAAN SEC.-6806

1.345 Kg/Mtr.

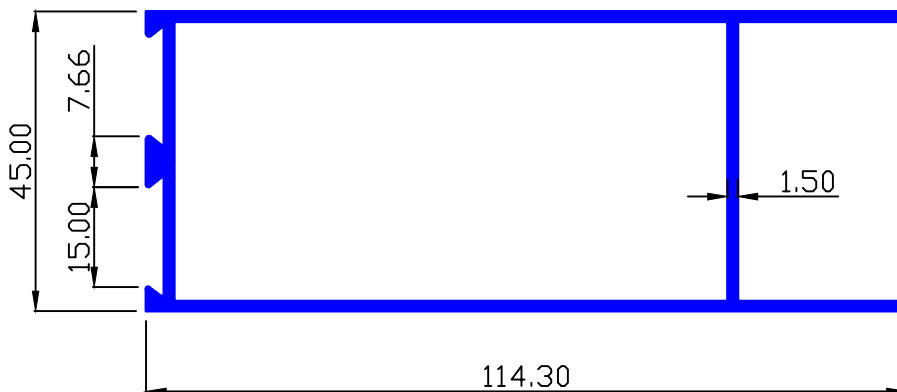

MAAN SEC.-6807

0.830 Kg/Mtr.

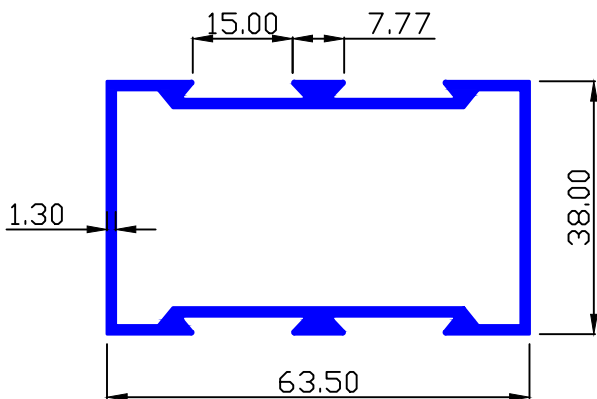

MAAN SEC.-6808

1.442 Kg/Mtr.

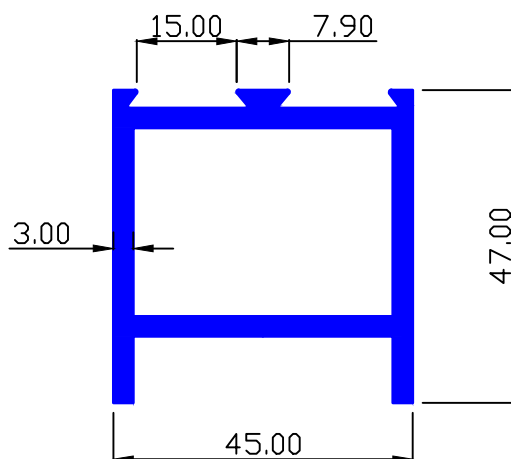

MAAN SEC.-6810/L

0.609 Kg/Mtr.

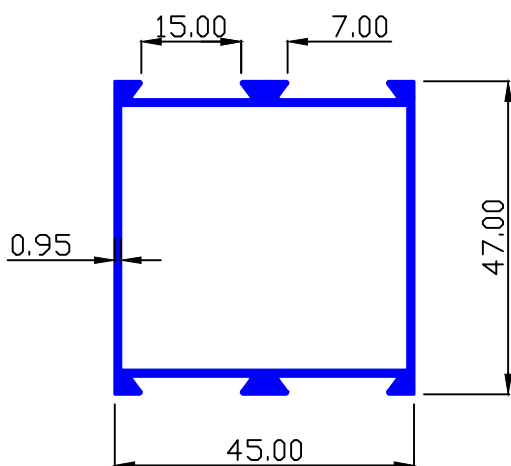

MAAN SEC.-6854

1.145 Kg/Mtr.

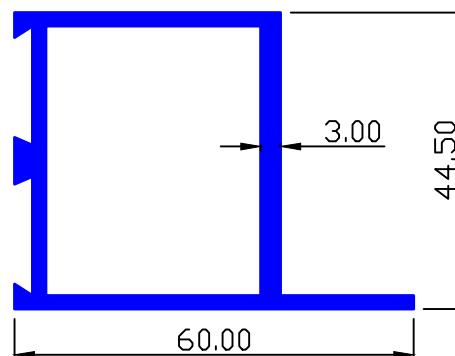



DOOR & WINDOW PARTITION

MAAN SEC.-6812

1.532 Kg/Mtr.

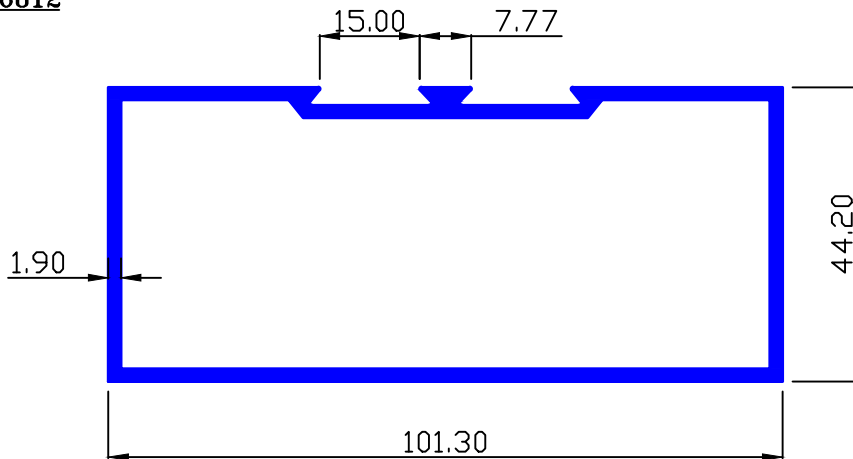

MAAN SEC.-6813

1.610 Kg/Mtr.

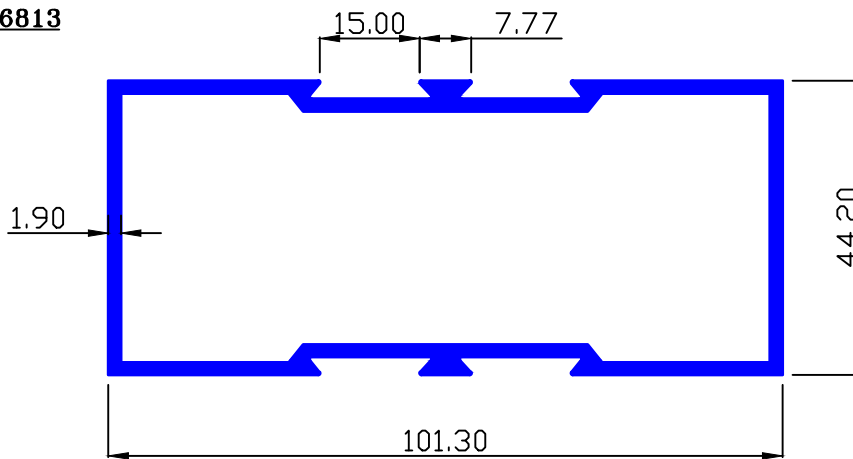

MAAN SEC.-6814

1.039 Kg/Mtr.

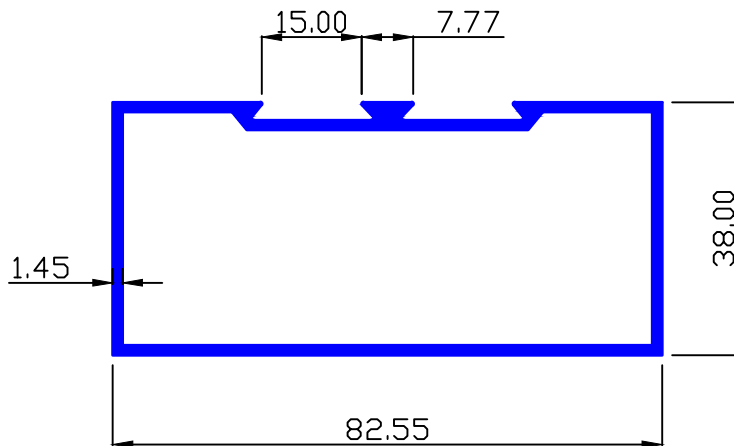



DOOR & WINDOW PARTITION

MAAN SEC.-6815

1.039 Kg/Mtr.

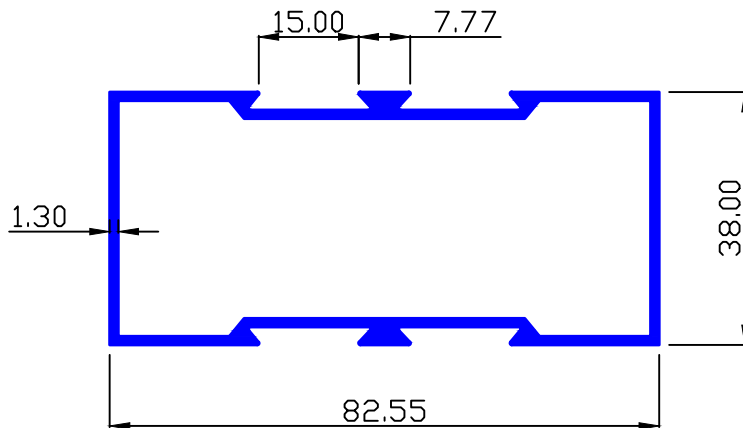

MAAN SEC.-6816

0.462 Kg/Mtr.

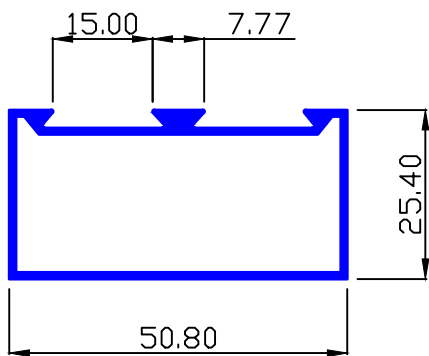

MAAN SEC.-6819

2.393 Kg/Mtr.

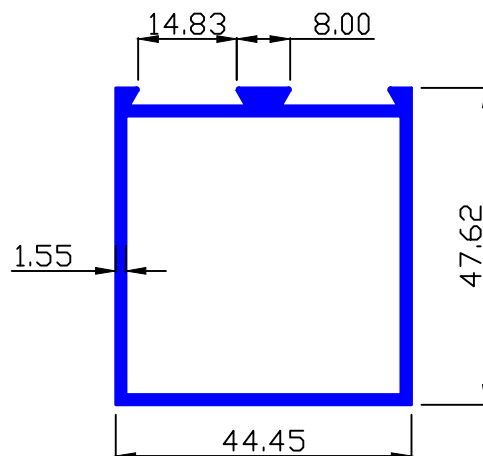

MAAN SEC.-6820

1.361 Kg/Mtr.

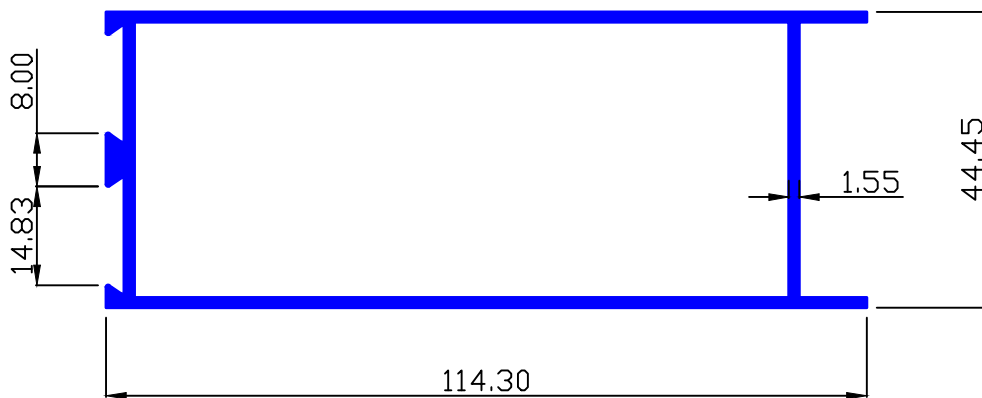



DOOR & WINDOW PARTITION

MAAN SEC.-6821

1.130 Kg/Mtr.

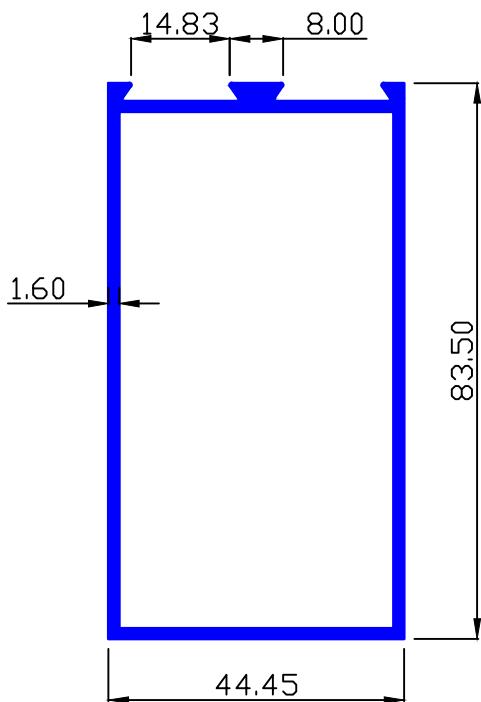

MAAN SEC.-6825

1.202 Kg/Mtr.

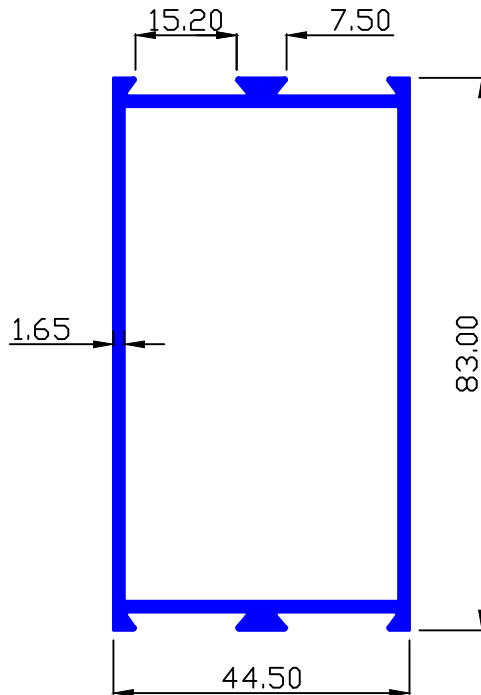

MAAN SEC.-6826

2.215 Kg/Mtr.

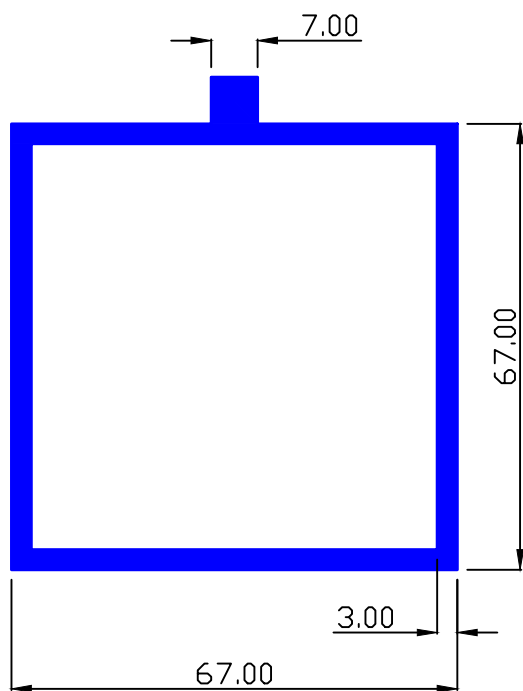

MAAN SEC.-6828

0.825 Kg/Mtr.

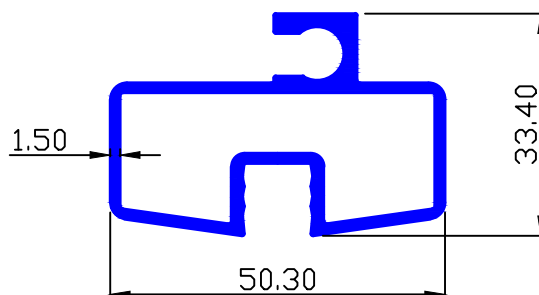

MAAN SEC.-6829

0.802 Kg/Mtr.

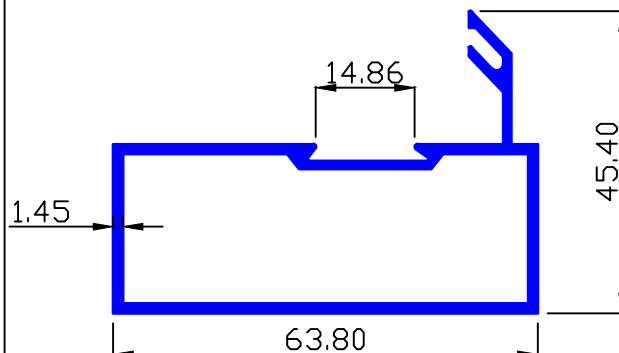



DOOR & WINDOW PARTITION

MAAN SEC.-6840

1.066 Kg/Mtr.

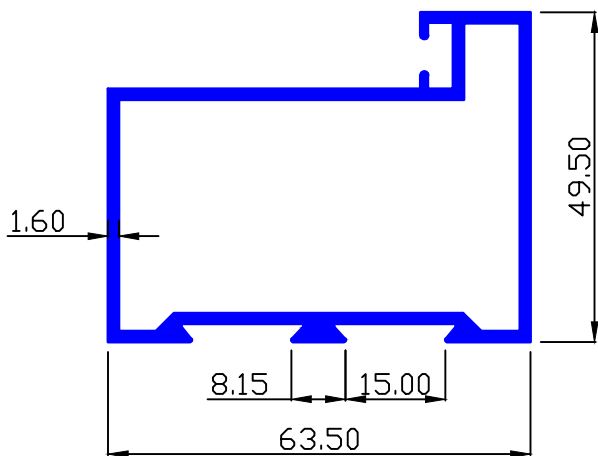

MAAN SEC.-6862

1.101 Kg/Mtr.

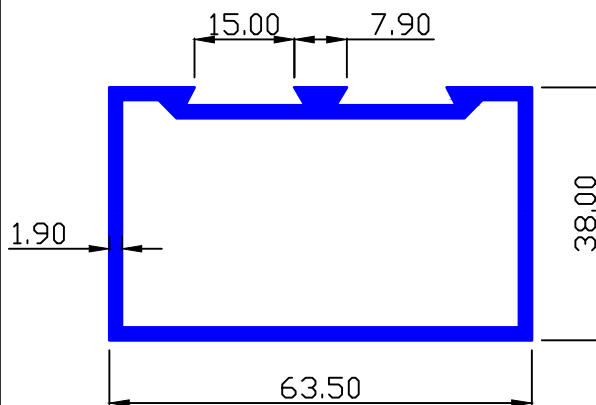

MAAN SEC.-6860

0.550 Kg/Mtr.

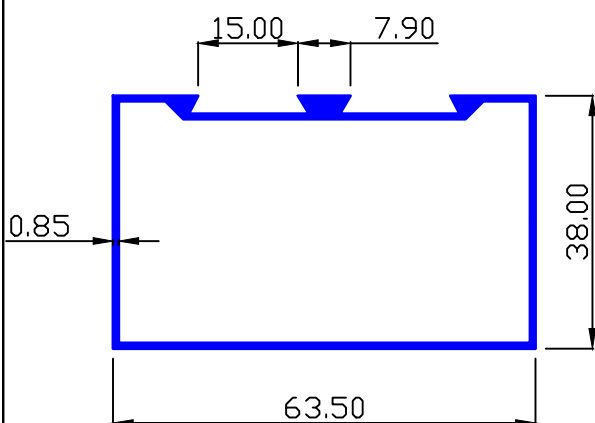

MAAN SEC.-6863

1.091 Kg/Mtr.

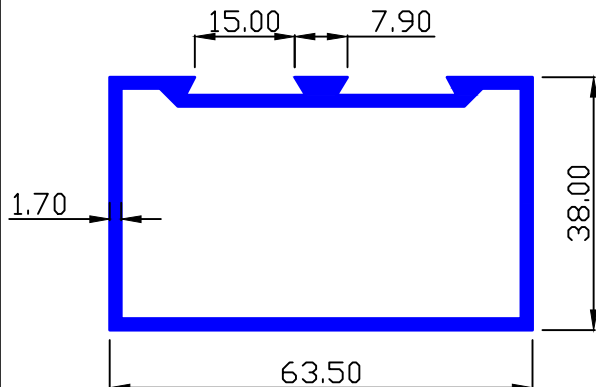

MAAN SEC.-6861

0.557 Kg/Mtr.

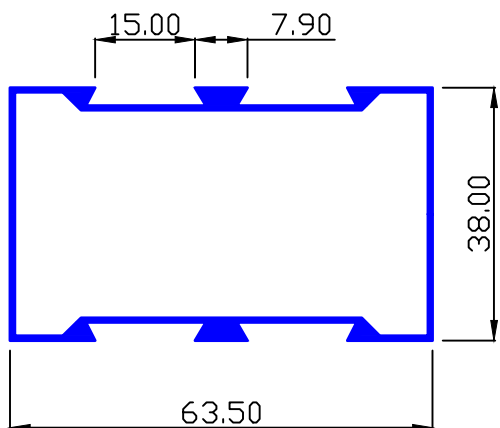

MAAN SEC.-7007

0.275 Kg/Mtr.

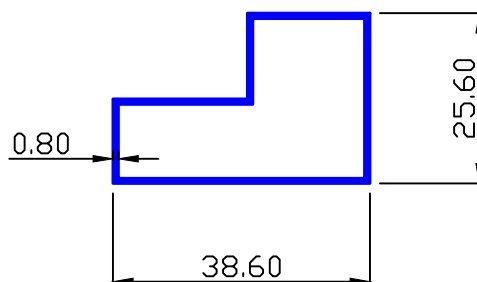



DOOR & WINDOW PARTITION

MAAN SEC.-6864

1.269 Kg/Mtr.

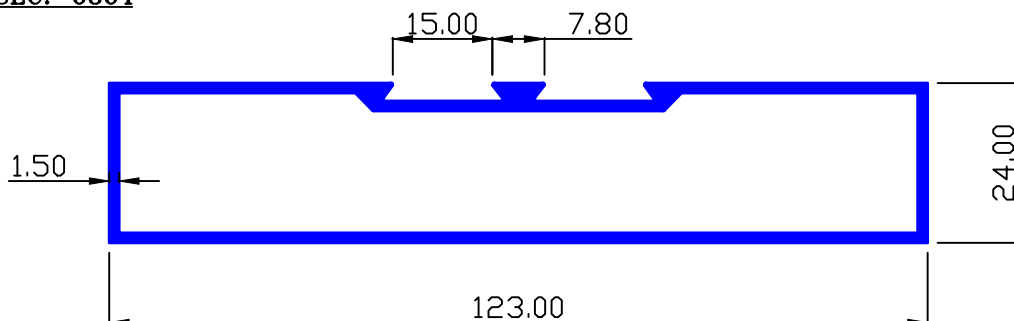

MAAN SEC.-6865

0.888 Kg/Mtr.

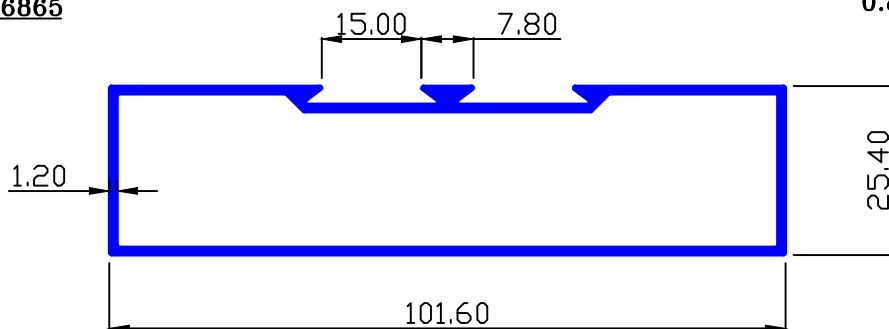

MAAN SEC.-7041

3.496 Kg/Mtr.

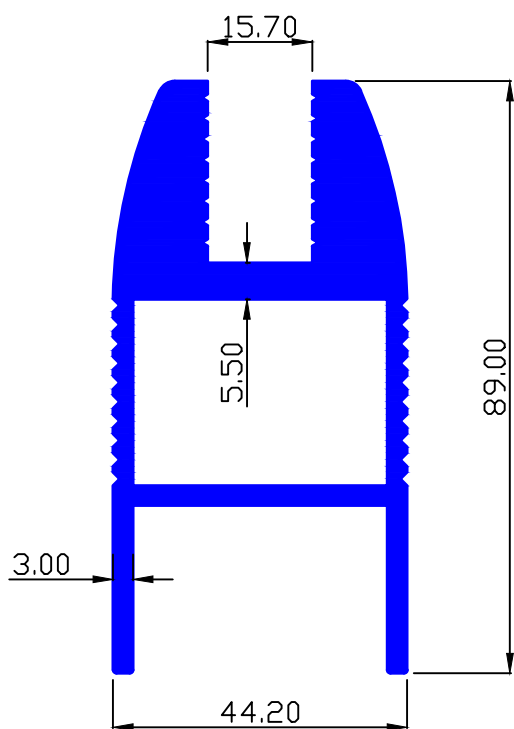

MAAN SEC.-7793

2.332 Kg/Mtr.

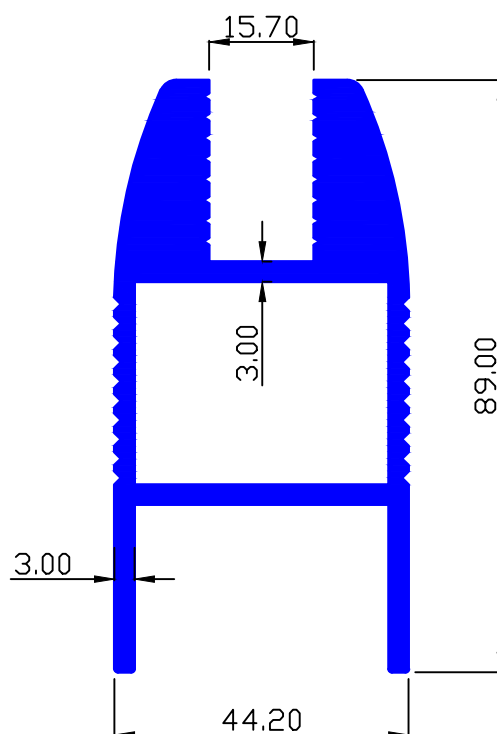



DOOR & WINDOW PARTITION

MAAN SEC.-7801

1.232 Kg/Mtr.

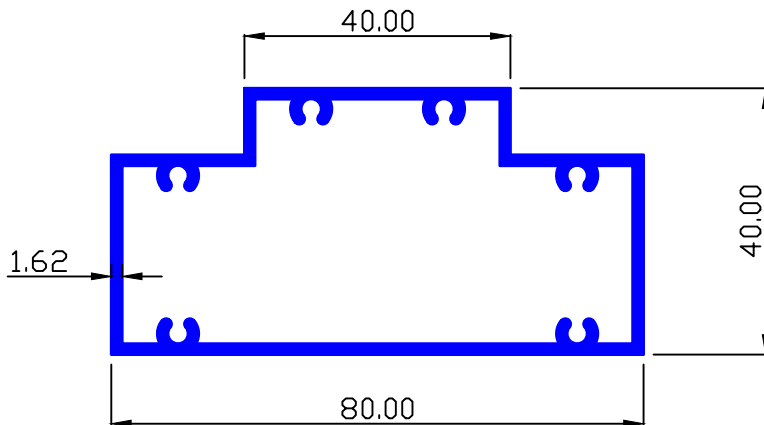

MAAN SEC.-7802

1.251 Kg/Mtr.

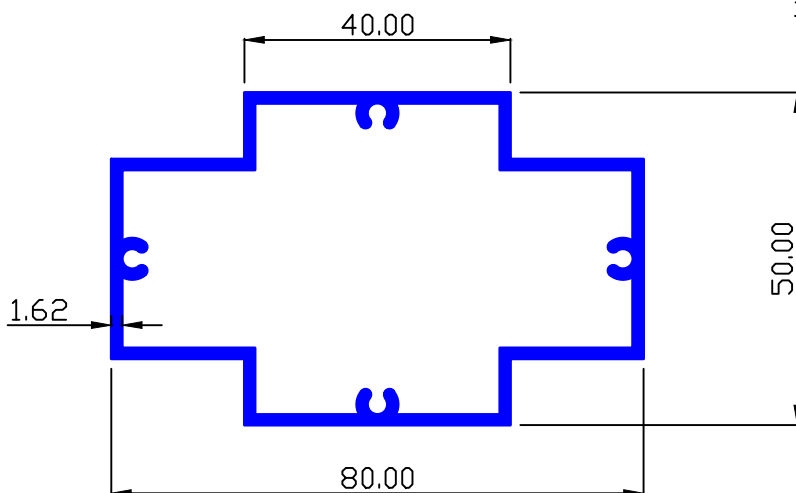

MAAN SEC.-7804

0.487 Kg/Mtr.

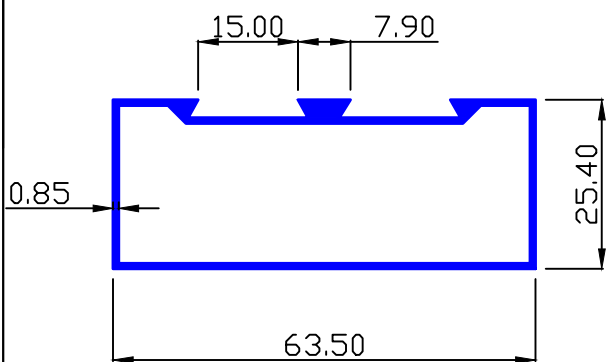

MAAN SEC.-7805

0.568 Kg/Mtr.

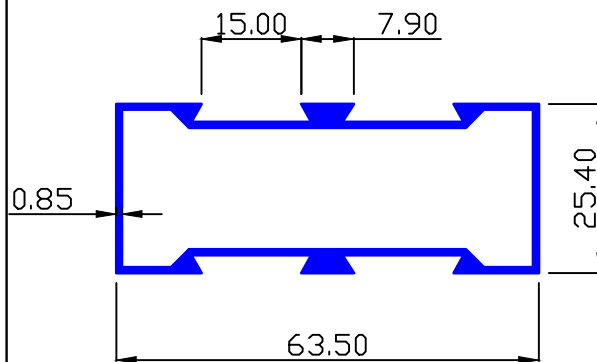



DOOR & WINDOW PARTITION

MAAN SEC.-7810

0.633 Kg/Mtr.

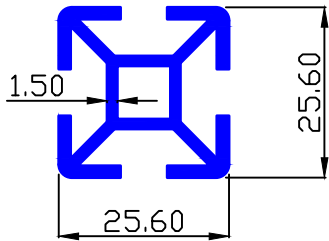

MAAN SEC.-7923

0.387 Kg/Mtr.

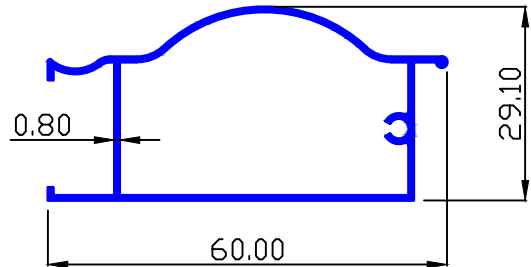

MAAN SEC.-7853

1.452 Kg/Mtr.

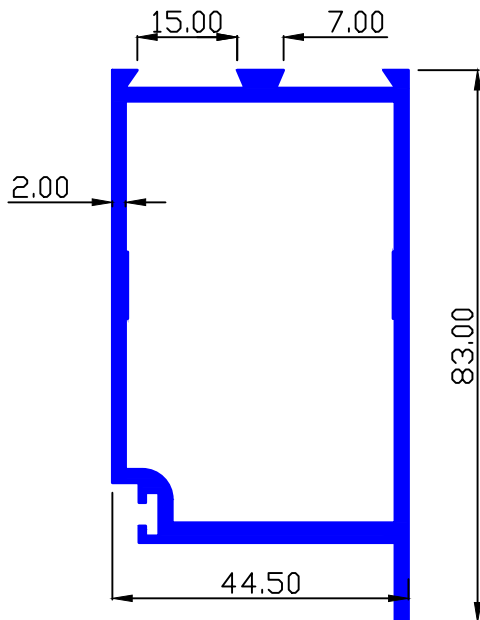

MAAN SEC.-7934

0.717 Kg/Mtr.

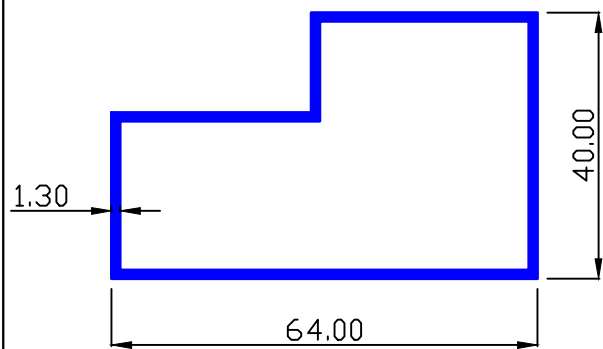

MAAN SEC.-7854

1.163 Kg/Mtr.

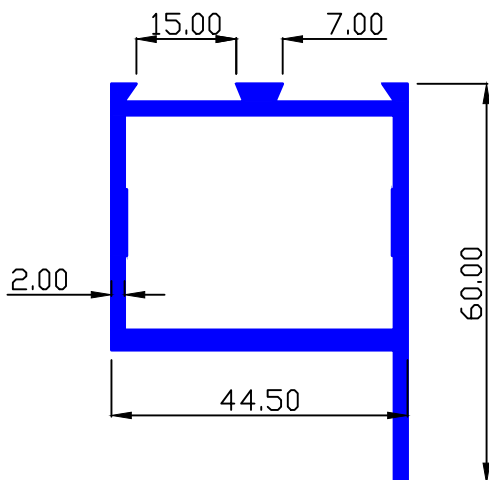

MAAN SEC.-7954

0.940 Kg/Mtr.

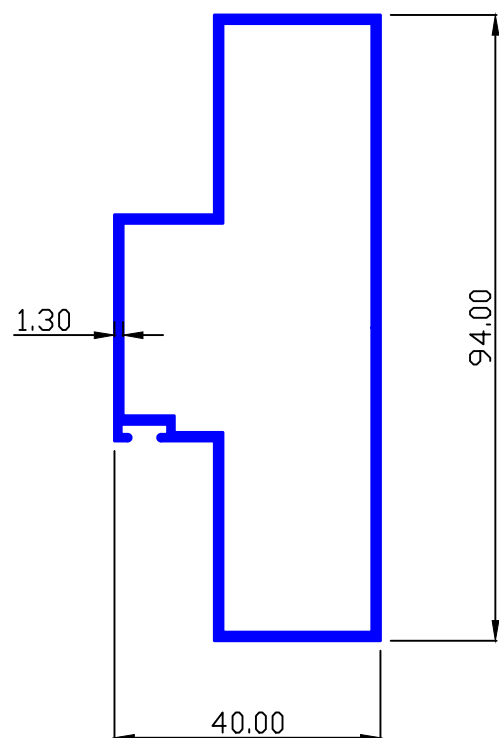



DOOR & WINDOW PARTITION

MAAN SEC.-6804

0.715 Kg/Mtr.

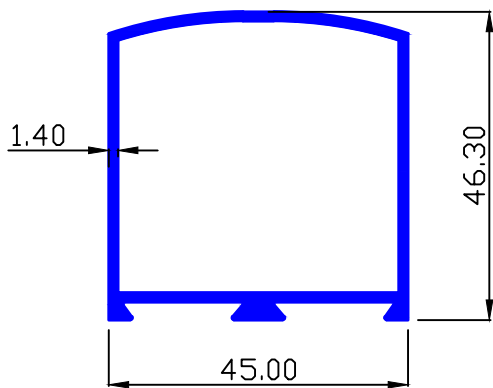

MAAN SEC.-6822

0.863 Kg/Mtr.

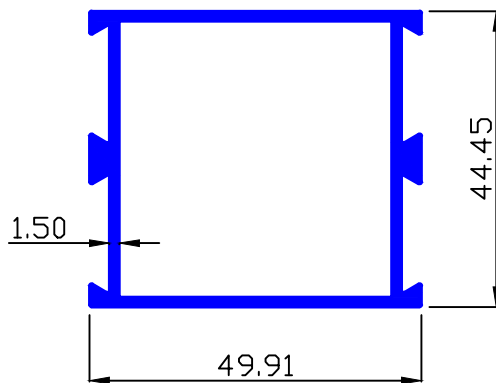

MAAN SEC.-6817

2.337 Kg/Mtr.

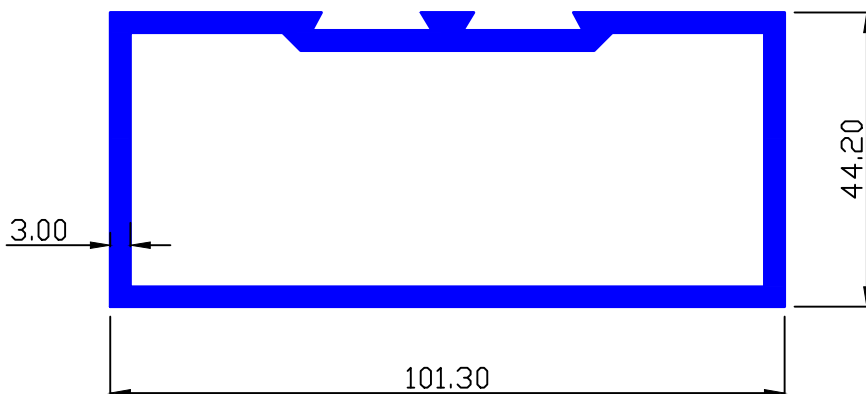

MAAN SEC.-6818

2.416 Kg/Mtr.

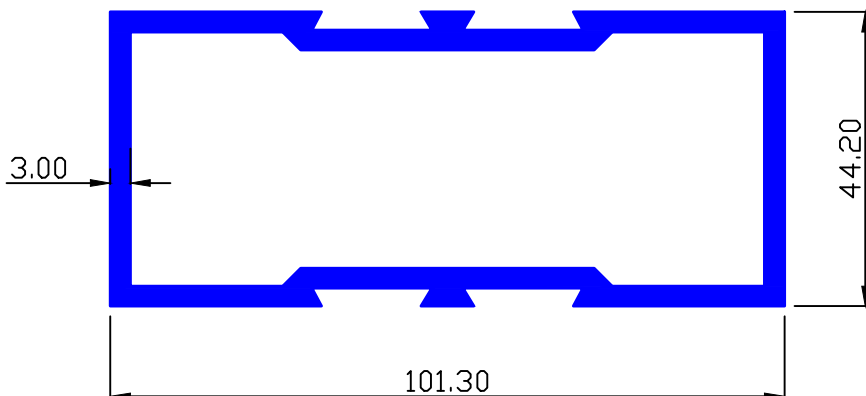



DOOR & WINDOW PARTITION

MAAN SEC.-6823

1.003 Kg/Mtr.

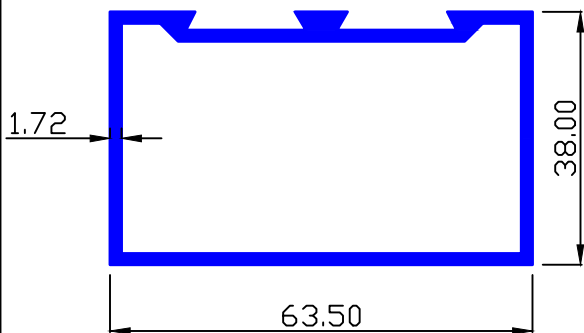

MAAN SEC.-6824

1.057 Kg/Mtr.

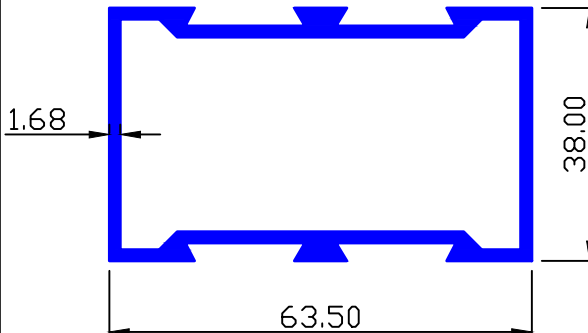

MAAN SEC.-6847

0.925 Kg/Mtr.

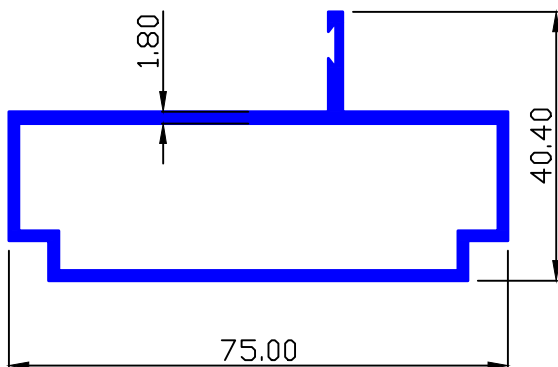

MAAN SEC.-90500

0.297 Kg/Mtr.

